

PENTAX

67II

Operating Manual

EN



To ensure the best performance from your camera,
please read the Operating Manual before using the camera.

Welcome to the Fantastic World of Pentax Medium Format Photography

This medium format 67 II camera gives an image area four times larger than that of the 35 mm SLR camera, assuring the photographer of fine-grained, superior quality image definition on enlargements.







The Aperture-Priority AE Mode and the metering modes of the Multi (6) Segment Metering, Center-Weighted Metering and Spot Metering Modes are available when the AE Pentaprism Finder 67 II is attached.

Read this instruction manual carefully to get a full explanation of operations before use.

The operating manual explains the camera with an optional AE Pentaprism 67 II attached.

Lenses and accessories produced by other manufacturers are not made to our precise specifications and therefore may cause difficulties with or actual damage to your Pentax camera. We do not assume any responsibility or liability for difficulties resulting from the use of lenses and accessories made by other manufacturers.

Icon indicators used in this manual

Operation direction	
Automatic operation	
Attention	
Lamp blinking	
Correct	
Incorrect	

PENTAX and SMC PENTAX are trademarks of HOYA CORPORATION.

FOR SAFE USE OF YOUR CAMERA

Although we have carefully designed this camera for safe operation, please be sure to follow precautions given on this page.



WARNING

This mark indicates precautions that, if not followed, could result in serious injury to the operator.



CAUTION

This mark indicates precautions that, if not followed, could result in minor or medium injury to the operator or damage to the equipment.



WARNING

- Wrapping the strap around your neck is dangerous. Make sure that small children do not get the strap caught around their neck.
- Do not look directly at the sun through the camera, as viewing the sun for an extended period may damage your eyes.



CAUTION

- Never try to disassemble, short or recharge the battery. Also, do not dispose of the battery in fire, as it may explode.
- Remove the batteries from the camera immediately if they become hot or begin to smoke. Be careful not to burn yourself during removal.

Precautions for Your Camera

Your Pentax camera is high-precision mechanism. Handle it with great care.

Precautions when taking pictures

- Do not use the camera where it may come in contact with rain, water, or any other liquid, because the camera is not weather, water, or liquid resistant. Should the camera get wet from rain, splashing water, or any other liquid, wipe it off immediately with a dry soft cloth.
- Do not drop the camera or allow it to hit solid objects. If the camera suffers a shock or impact, take it to a Pentax service center for inspection.
- Be careful not to subject the camera to strong vibrations, shock or pressure. Use a cushion to protect the camera when carrying it in a motorcycle, car, boat, etc.
- Condensation on the interior or exterior of the camera may be extremely harmful to the camera mechanism as it may cause rust. Furthermore, if the camera is taken from warm temperature to subfreezing or vice versa, the formation of condensation may cause damage. In such case, put the camera into a case or plastic bag so that any changes in temperature difference is minimized. Do not remove it from the bag until temperature has stabilized.

Precautions for storage

- Avoid leaving the camera for extended periods in places where the humidity and temperature are very high, such as in a car.
- Do not store the camera in a closet with mothballs or in an area where chemicals are handled. Store it in a place with good dry air circulation to prevent the growth of fungus.

Precautions for proper care

- Never touch the shutter curtain or mirror with your finger or any other object.
- Use a blower and lens brush to remove dust accumulated on the lens or viewfinder.
- Never use solvents such as paint thinner, alcohol or benzene to clean the camera.

Electrical problems may often be caused by water, dirt or dust at points of electrical contact. Also check for battery leakage, traces of dirt or grease, or corrosion due to salinity or gas. If you cannot correct the problems, have your camera inspected at a Pentax service center. Repairs of this nature are not covered under the terms of the warranty and charges may be assessed.

Other precautions

- The temperature range at which this camera functions properly is 50 °C to -10 °C (122 °F to 14 °F).
- A camera which has been submerged in water usually cannot be repaired. If such an accident should occur, it is advisable to contact a Pentax Service Center immediately.
- To maintain optimum performance, it is recommended that the camera be inspected every one or two years. If the camera has not been used for an extended period, or is being prepared for an important photographic session, it is recommended that you have the camera inspected or test shoot with it.
- Repairs deemed necessary due to usage of this product in an industrial or commercial application may not be covered under the terms of the Pentax warranty.
- The Pentax warranty provides only for the repair of defects in materials or workmanship. Damage of any kind cannot be repaired at no charge under the terms of the warranty. If the difficulty is caused as a direct result of the product being used in conditions as outlined in the "Precautions for Your Camera" section or any other operation contrary to the instructions outlined in this manual, charges will be assessed and a repair quotation will be provided.

Precautions for Battery Usage

- Use two CR123A lithium batteries.
- Do not store the camera in a closet with mothballs or in an area where chemicals are handled. Store it in a place with good dry air circulation to prevent the growth of fungus.
- Misuse of the battery can cause hazards such as leakage, overheating, explosion, etc. The battery should be inserted with the "+" and "-" sides facing correctly.
- Battery performance may be temporarily hindered in low temperatures, but will recover in normal temperatures.
- Keep spare batteries on hand for convenient replacement when shooting outdoors or while traveling.
- Replace the batteries at the same time. Do not mix battery brands, types, or old batteries with new ones, as this may cause explosion or overheating.

Table of Contents

PENTAX
67II

FOR SAFE USE OF YOUR CAMERA.....	1
Precautions for Your Camera	2
Precautions for Battery Usage.....	3
Names of Working Parts.....	6
Indicators	8
To Take the Following Kinds of Pictures	9
To Start Taking Pictures Right Away	10
Structure of this Manual.....	12

I BASIC OPERATION [PREPARATION]

Attaching the Camera Strap.....	13
Loading the Batteries	14
Turning the Power ON	16
Low Battery Warning.....	17
Attaching the Lens	18
Depressing the Shutter Release Button.....	20
About Interchangeable Viewfinder	21

Setting the Film Speed (ISO).....	24
Loading the Film	25
Unloading the Film.....	31
Adjusting the Viewfinder Diopter.....	33
Installing the Correction Lens	34

III BASIC OPERATION [SHOOTING]

Using the Aperture-Priority AE Mode.....	35
Using the Multi (6)-Segment Metering Mode ...	36
Holding the Camera.....	38
Taking a Picture.....	39

III ADVANCED OPERATION

Using the Self-Timer Mode	43
Eyepiece Shutter	44
Multiple-Exposure Mode	45

Selecting an Exposure Mode.....	47
● Using the Aperture-Priority AE Mode.....	47
● Using the Metered Manual Mode.....	49
● Using the Bulb Exposure Mode	52
About Exposure Compensation.....	54
Switching the Metering Mode	55
● Using the Center-Weighted Metering Mode	55
● Using the Spot Metering Mode	56
Using the Memory Lock Function	57
Using a PENTAX Dedicated External Flash....	58
Slow-Speed-Sync Shooting.....	63
Checking the Depth-of-Field.....	64
Mirror Look-Up.....	65
Time Exposure Mode	66
Infrared Index	68
Accessories (Optional)	69
● Interchangeable Focusing Screen	70
Aperture and Shutter Speed Effects.....	73
Custom Function	75

IV OTHERS

Troubleshooting	76
Error Display in the Event of Incorrect Operation	77
Specifications	78
WARRANTY POLICY.....	80

Names of Working Parts

Top front

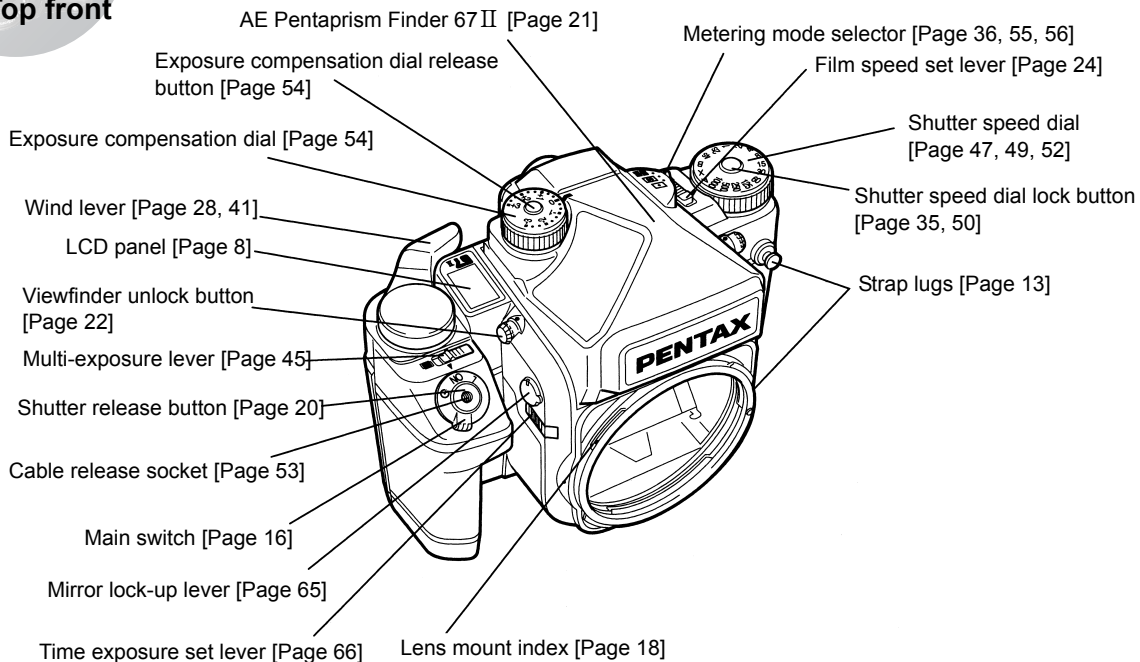

Bottom back

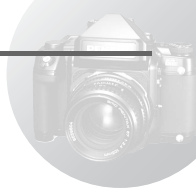
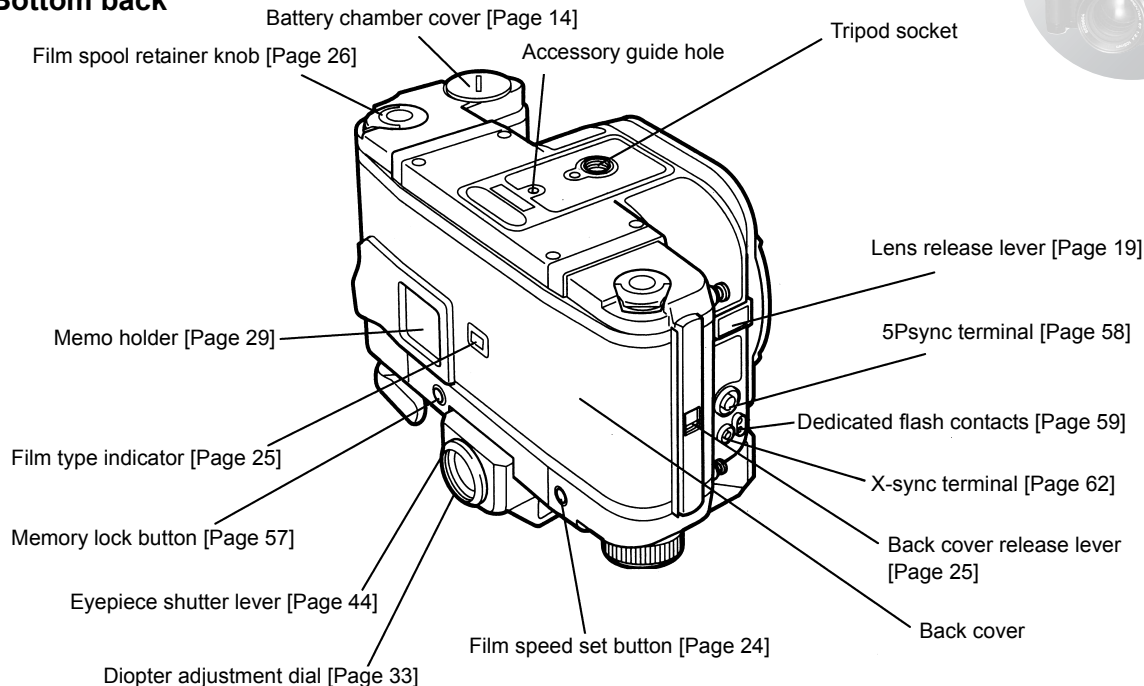



Indicators

The indicators displayed on the LCD panel and viewfinder show the following information.







LCD Panel

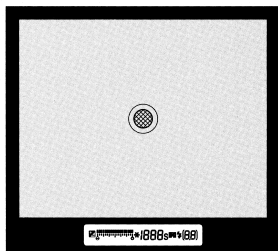

- 8.8** : Film counter [Page 29]
- 8888** : Film speed [Page 24]
- ISO** : Film speed set information [Page 24]
-  : Low battery warning [Page 17]
- FILM** : Film symbol [Page 29]
-  : Film advance indicator [Page 42]
-  : Flash status [Page 58]

Viewfinder



- 888s** : Shutter speed [Page 48, 51]
- (88)** : Film counter [Page 30]
-  : Flash status [Page 58]
-  : Exposure compensation [Page 54]
-  : Memory lock [Page 57]
-  : Bar graph [Page 51, 54]
-  : Metering mode [Page 36, 55, 56]
-  : Spot metering area [Page 56]
-  : Microprism [Page 39]

* As the periphery of the image may be cut off when the image is printed out, compose your image with extra space around it.

To Take the Following Kinds of Pictures



Flash

Page

- To take a picture in a dark place or indoors 58
- To take a picture of a subject with a night scene in the background 63



Exposure (Brightness)

Page

- To take a picture with brightness manually adjusted 49, 54
- To take a picture into the sun with the subject's face lightened 54
- To measure the brightness of a specific narrow area 56
- To store the exposure in the camera temporarily 57



Subject Photography

Page

- To take a picture of yourself 43
- To take a picture into the sun with the subject's face lightened 54
- To take a picture of a subject with a night scene in the background 63



Landscape Photography

Page

- To take a picture of a night scene 52
- To take a picture of a subject with a night scene in the background 63



Other

Page

- To layer multiple pictures in one frame 45
- To reduce mirror shock when taking a picture 63



To Start Taking Pictures Right Away

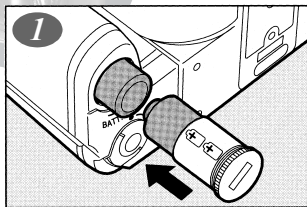

Load the Batteries

Remove the battery chamber cover and load two CR123A batteries.

[Page 14]

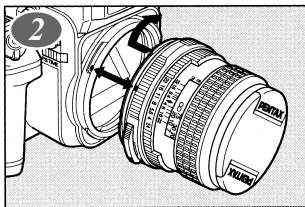

Attach the Lens

Align the red dots on the camera and lens mount, attach the lens to the camera body, and turn it to the right until it locks. [Page 18]

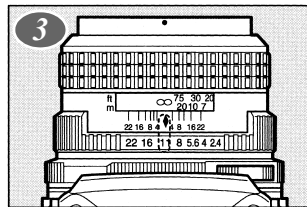

Set the F-Stop

Set the lens aperture ring to the desired f-stop. [Page 35]

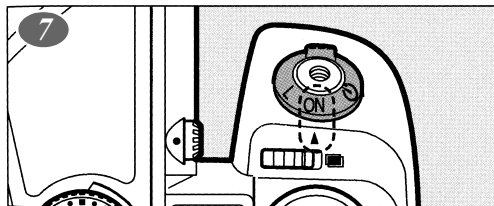

Turn the Power On

Set the main switch to **ON**. [Page 16]

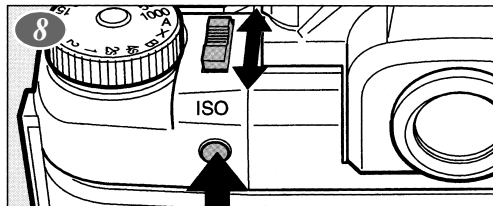

Set the Film Speed

Adjust the film speed using the film speed set lever and film speed set button. [Page 24]

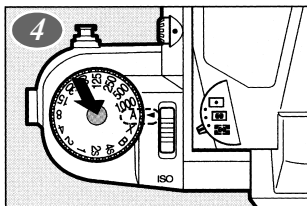

Turn the Shutter Speed Dial to **A**

Turn the dial while holding down the button indicated in the diagram. This sets the Aperture-Priority AE Mode. [Page 35]

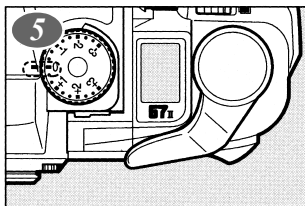

Set Exposure Compensation to **0**

Turn the exposure compensation dial to the **0** position. [Page 54]

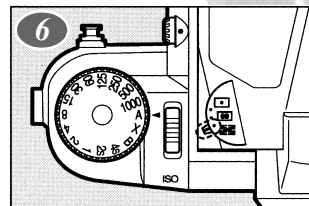

Set the Multi (6)-Segment Metering Mode

Set the metering mode selector to **6**. [Page 36]

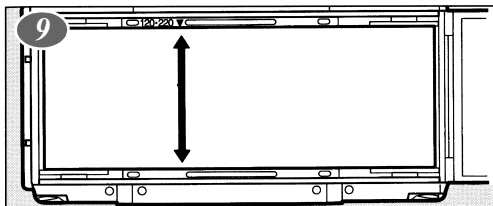

Load Film

Open the back cover and load the film correctly. [Page 25]

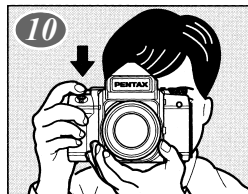

Adjust the Focus and Take a Picture

Depress the shutter release button gently to take a picture. [Page 39]

Structure of this Manual

For effective use of this manual, the contents have been arranged in the following order.

I

BASIC OPERATION [PREPARATION]

Page 13 to 34

II

BASIC OPERATION [SHOOTING]

Page 35 to 42

III

ADVANCED OPERATION

Page 43 to 75

IV

OTHERS

Page 76 to 81

- If you want to start taking pictures right away, please read “BASIC OPERATION [PREPARATION]”, and “BASIC OPERATION [SHOOTING]”. You can enjoy simple photography even with a minimal knowledge of operating the camera.

Attaching the Camera Strap

- Adjust the length of the strap with the buckle.
- After fitting the strap and adjusting the length, pull the strap hard to confirm that the strap is securely attached to the camera.
- The strap has a pocket for carrying small goods.

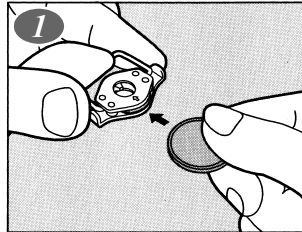

Press the lock plate of the clasp in the direction of the arrow with a coin or similar object.

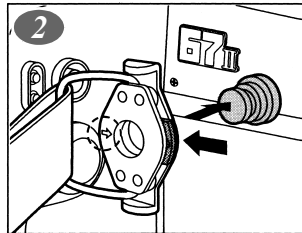

Place the clasp onto the strap lug with the part indicated by the arrow enclosed by the dotted line facing out, and return the lock plate to the original position. It will securely attach to the strap lug.

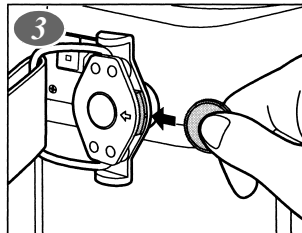

To remove the strap, slide the lock plate with a coin or similar object as shown in step **1**.

Loading the Batteries

- If any indicators are not displayed on the LCD panel even though a battery is loaded, confirm that the battery chamber cover is closed at the correct angle.
- Do not replace the battery while winding up the film. If you do so, the film counter on LCD panel advances by two from the current display and the number of pictures that can be taken decreases by one.
- Do not wind up the film when the battery is not loaded in the camera. The space between frames may increase causing the number of pictures that can be taken to decrease.

Next page ➡➡

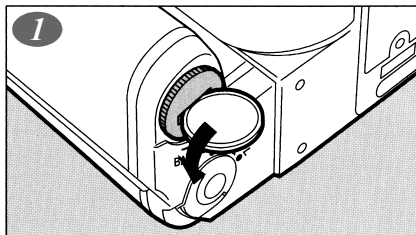

Remove the battery chamber cover with a coin or similar object as shown in the illustration.

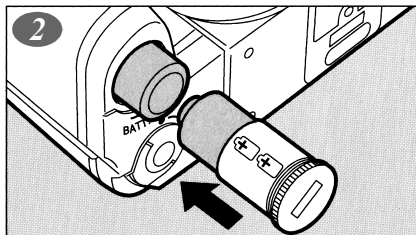

Load two 3V lithium batteries (CR123A or the equivalent) as shown in the illustration.

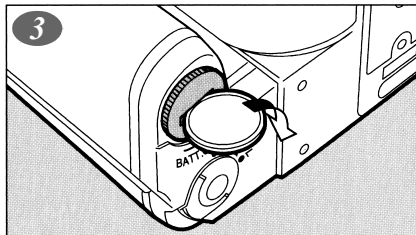

Turn the battery chamber cover in the direction of the arrow to lock it securely.



- This camera requires battery power for operation. Always use two CR123A lithium batteries or the batteries included in the package.
- The ISO film speed and number of exposed frames are unchanged even if the batteries are replaced.
- Keep spare batteries on hand for convenient replacement when shooting while traveling abroad or in cold places, or when shooting many pictures.
- Replace all the batteries at the same time. Do not mix battery brands, types or old batteries with new ones.

Battery life and bulb exposure time

[20°C], using new batteries, based on our testing conditions.

120 film	Approx. 500 rolls
220 film	Approx. 250 rolls
Bulb exposure time	Approx. 13 hours

Battery life and the bulb exposure time

[-20°C], using new batteries, based on our testing conditions.

120 film	Approx. 250 rolls
220 film	Approx. 120 rolls
Bulb exposure time	Approx. 6 hours

- The batteries were used under our testing conditions. Actual battery life and performance may vary drastically depending on external conditions such as temperature and freshness of the battery.
- Battery performance may be temporarily hindered in low temperatures, but should recover in normal temperatures. Also, the number of pictures that can be taken decreases in low temperatures.
- The batteries included in this package are sample batteries. Therefore, you may not be able to take the number of pictures shown above.

Turning the Power ON

- When the camera is not in use, make sure that the main switch is set to **L** to prevent battery drain if the shutter release button is accidentally depressed.

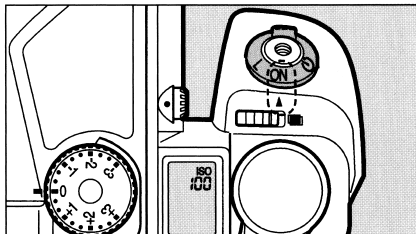

Set the main switch to **ON**.

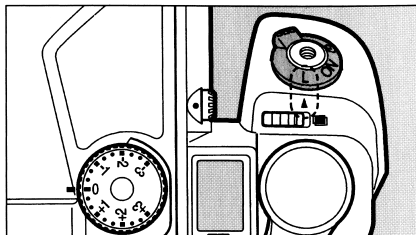



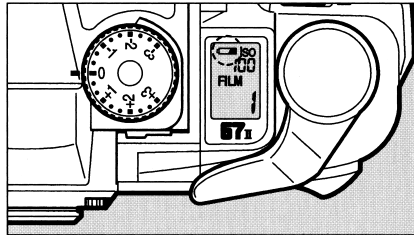

The power is turned off when the main switch is set to **L**.

Low Battery Warning

- Do not replace the battery while winding up the film. If you do so, the film counter on LCD panel advances by two from the current display and the number of pictures that can be taken decreases by one.



When the batteries are nearly exhausted, the low battery warning  appears on the LCD panel as a warning. Replace the batteries as soon as possible. See page 14 for replacing the batteries.

- Even if the low battery warning  appears, exposure will be correct as long as the shutter can be released.
- When the low battery warning  starts blinking, the indicators on the LCD panel disappear and the shutter cannot be released. Also, you may not be able to wind up the film at its beginning and end.
- Do not wind up the film when the low battery warning  is blinking. The end of the film cannot be detected properly.

Attaching the Lens

- See the operation manual “INTERCHANGEABLE LENSES” for 67 lenses when attaching or removing an outer bayonet lens for a large lens.
- Do not operate the lens release lever shown in page 19 when attaching the lens. Doing so may result in the lens not being able to be attached to the camera properly.
- We assume no responsibility nor liability for damages resulting from the use of lenses made by other manufacturers.

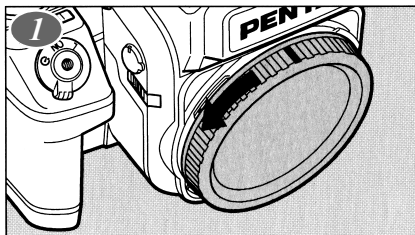

Remove the body mount cap by turning it in the direction of the arrow.

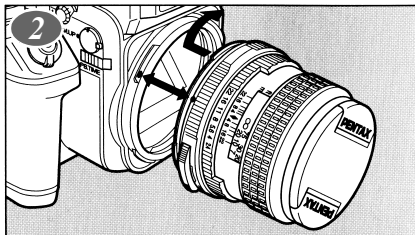

Align the red dots on the camera and lens mount, attach the lens to the camera body, and turn it fully to the right until you hear a click.

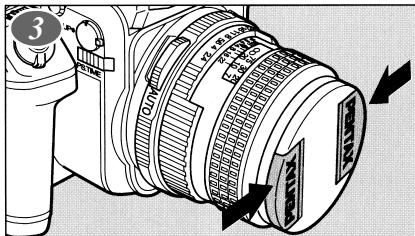

To remove the front lens cap, squeeze the tabs on both sides in the direction of the arrow.

- To protect the lens against damage after removal, be sure to set the lens down with the mount side facing upward.

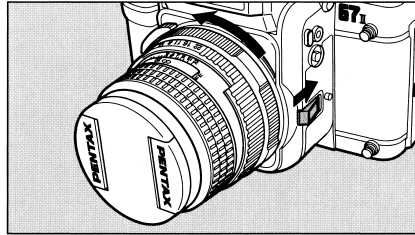

How to remove

To remove the lens, turn it to the left while depressing the lens release lever.

Depressing the Shutter Release Button

- To prevent the camera shake, depress the shutter release button gently.
- Before loading a roll of film, slowly depress the shutter release button to learn where the first position is.
- The indicators in the viewfinder stay on for about 10 seconds after the button is released from the halfway position. Depressing the shutter release button down halfway keeps the indicators in the viewfinder on.

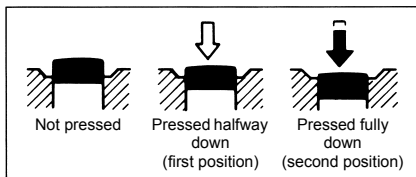

The shutter release button has two positions.

Depressing it halfway (first position) turns the indicators in the viewfinder on. Depressing it fully (second position) releases the shutter.

About Interchangeable Viewfinder

Four types of optional interchangeable viewfinders are available.

- When the AE Pentaprism Finder 67 II is attached to the 67 II camera, the Aperture-Priority AE Mode and the Metered Manual Mode are usable.
- The Pentaprism Finder, Folding Focusing Hood or Rigid Magnifying Hood used for 67 camera can also be attached to the 67 II camera.
- The TTL Pentaprism Finder used for the 67 camera cannot be used to the 67 II camera.



AE Pentaprism Finder 67 II



Pentaprism Finder 67 II



Folding Focusing Hood 67 II

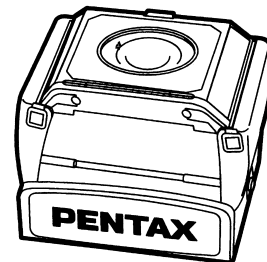

Rigid Magnifying Hood 67 II

- When the AE Pentaprism Finder is not attached properly, [PErr] may appear on the LCD panel.

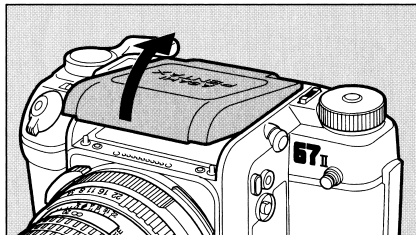

Remove the cover as illustrated.

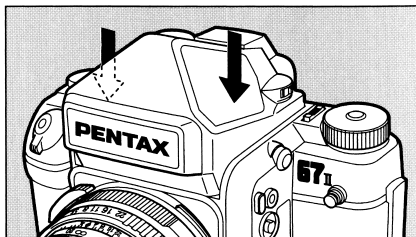

Attaching the viewfinder

Place the viewfinder on the upper part of the camera as illustrated and press it down until it clicks two times.

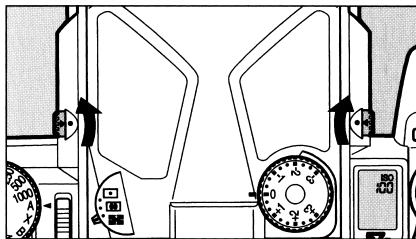

Detaching the viewfinder

Turn the viewfinder unlock button in the direction of the arrow to align the red dots on the camera.

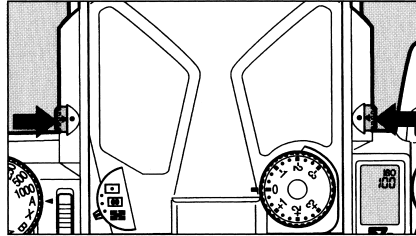

Depress the viewfinder unlock button to remove the viewfinder.

Setting the Film Speed (ISO)

- Holding the lever will change the film speed continuously.
- The film speed setting range is ISO 6 to 6400 in 1/3 EV step increments.
- **ISO** and film speed are always displayed on the LCD panel when the main switch is set to the ON position.

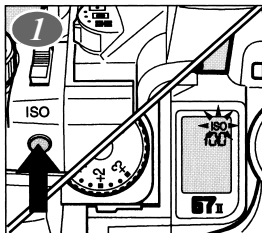

Depress the film speed set button. The ISO indicator on the LCD panel blinks.

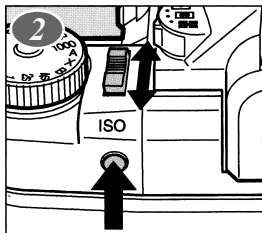

While depressing the film speed set button, move the film speed set lever to change the film speed.

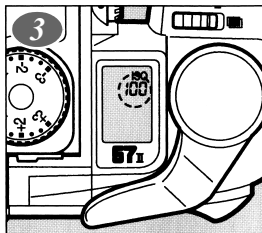

To change the film speed to a larger number (higher film speed), move the lever toward the front repeatedly until the desired ISO appears on the LCD panel. To change the film speed to a smaller number (lower film speed), move the lever toward the back repeatedly until the desired ISO appears on the LCD panel.

Loading the Film

Be sure to set the proper film speed before the film is loaded. See page 24 for setting the film speed.

- Film drag will occur or the end of the film cannot be detected when the 220 pressure plate is set for a 120 film. Imprecise focusing will occur or the number of pictures that can be taken decreases when the 120 pressure plate is set for a 220 film.

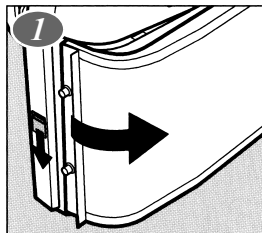

Open the back cover by sliding the back cover release lever.

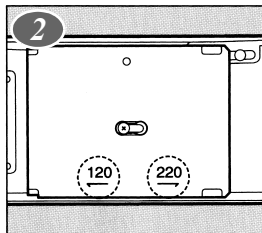

Depress and shift the pressure plate according to the film type (120 or 220) you use.

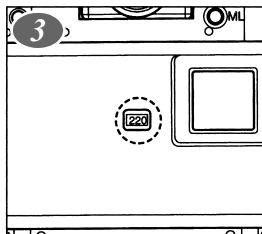

The pressure plate you set will be indicated in the film type indicator.

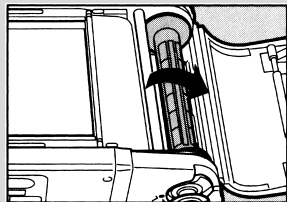

- If the film spool retainer knob does not fit in the proper position, turn the spool in the direction of the arrow as shown in the illustration.

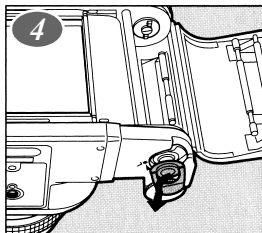

Unfold the crank of the film spool retainer knob, turn the knob to the left and pull down.

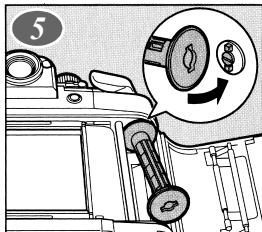

Install the emptied spool to the spool retainer as illustrated.

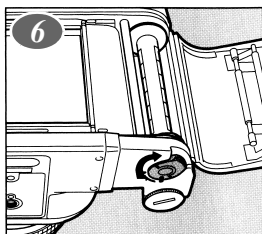

Push in the film spool retainer knob and turn it to the direction of the arrow.

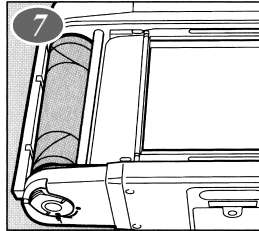

Tear off the tape from the film and install the film to the spool retainer in the same manner as installing the emptied spool so that the letters on the leader paper are facing outwards.

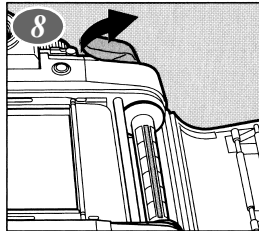

Turn the wind lever until the slot of the empty spool faces upward.

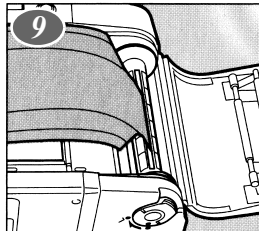

Draw the film leader from the film roll, and insert the tip of the leader into the spool's slit.

- If a battery is not loaded, the spool will not turn even if the wind lever is turned.

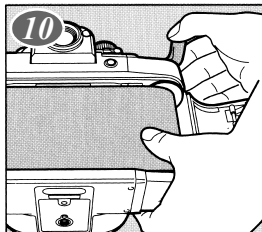

Turn the wind lever while lightly pressing the film leader.

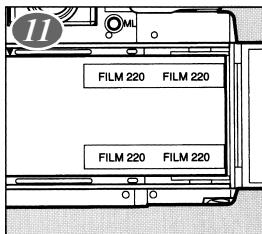



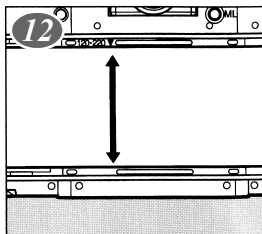



Confirm that the film leader is evenly wound onto the spool.

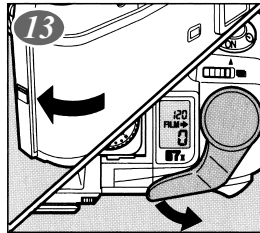



Turn the wind lever until the arrow marking on the leader paper aligns with the ▼ mark on the camera.

- When the film does not advance even if the wind lever is turned, turn the wind lever twice after closing the back cover. Then release the shutter, open the back cover and repeat the film winding procedure from step 10.

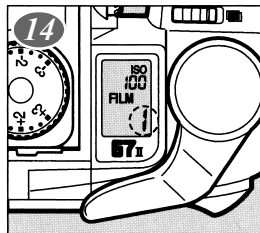

Close the back cover. Keep turning the wind lever until the wind lever stops. The film counter indicator , film type  or , film symbol , and  advising you to wind up the film will appear on the LCD panel.



 appears on the LCD panel when the film is properly loaded.

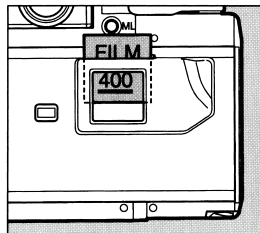

You can tear off the end cover of the film package indicating the type of film and speed and insert it into the memo holder provided on the back cover to remind you of the film type/speed that you are using.

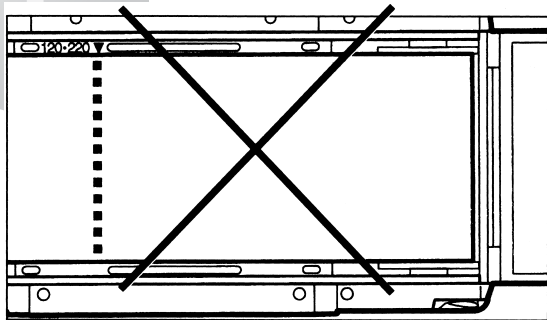



CAUTION

Align the start mark of the film and the ▼ mark of the camera as shown in step 12 of page 28. With a 220 film loaded, the dotted line appears as illustrated. This is not a start mark. Do not align this line with the ▼ mark. Doing so may result in the first three frames not being exposed.

- The film counter indicator is also displayed in the viewfinder.
- Always unload the film in the shade or using your body to shade the film holder.
- We suggest that you first operate the camera with no film loaded to become familiar with its operations.
- The film counter indicator on the LCD panel and in the viewfinder advances by one each time the film is wound. The film counter indicator on the LCD panel is displayed even when the camera is turned off.
- Always keep the surface of the pressure plate clean as dust and smudges may cause scratches on the film. The pressure plate can be wiped clean with a dry cloth.
- If the start mark on the leader paper is not set with the ▼ mark on the camera, you may lose the first or last frame(s) on the roll.
- 10 pictures are taken with the 120 film and 21 pictures are taken with the 220 film.
- If you open the back cover when there is no film loaded, you have to cock the shutter twice to release the shutter.
- To release the shutter with the back cover opened, cock the shutter while holding down the multi-exposure lever.

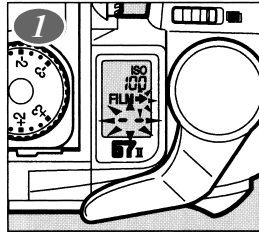
Unloading the Film



After the last frame of the roll is exposed,  and  on the LCD panel blink.

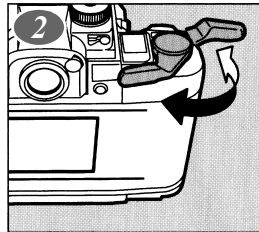

The film speed indicator will disappear when you wind up the film. Repeat winding the film several times.

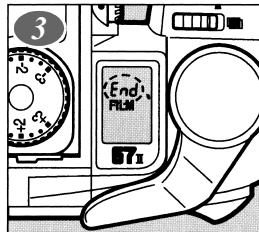

Wind the leader paper until  appears on the LCD panel.

BASIC OPERATION [PREPARATION]

I

- Always unload the film in the shade or using your body to shade the film holder.

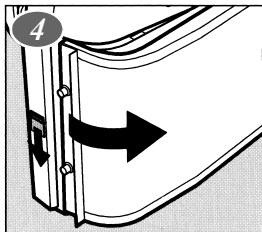

Confirm that **End** is displayed on the LCD panel. Open the back cover.

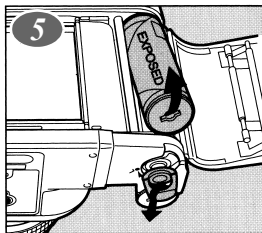

Unfold the crank of the film spool retainer knob, turn the knob to the left and pull down.

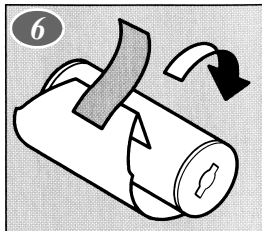

Fold the end of the leader paper and then affix the paper seal securely on the back of the paper leader to prevent accidental unwinding of the exposed roll.

Adjusting the Viewfinder Diopter

- The diopter adjustment range is $+1.5 \text{ m}^{-1}$ to -2.5 m^{-1} (per meter).
- Be sure to adjust the diopter before use.

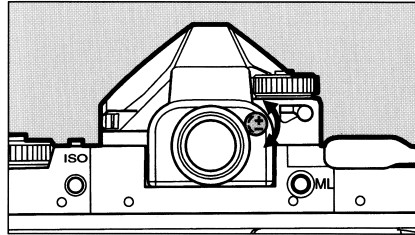

Aim the camera at a bright subject. While looking through the viewfinder, turn the diopter adjustment dial to the left or right until the microprism grid appears in the sharpest focus.

Installing the Correction Lens

- The diopter adjustment range can be changed from -5.5 to -1.5 or -0.5 to $+3.5$ by changing the optional correction lenses.

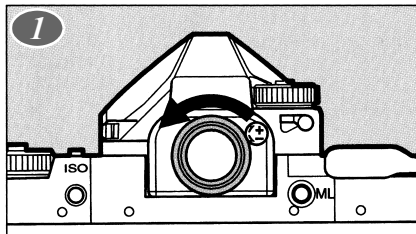

Turn the rubberized eyepiece frame to the left and remove it.

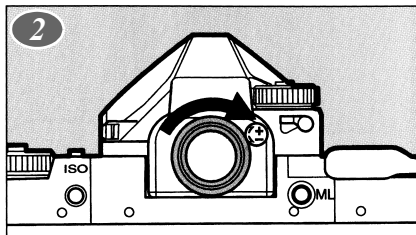

Install the desired correction lens as illustrated.

Using the Aperture-Priority AE Mode

When the desired aperture is selected, an appropriate shutter speed is automatically set by the camera for a proper exposure.

- The shutter speed dial can be released from to another position in the same manner as step ②.

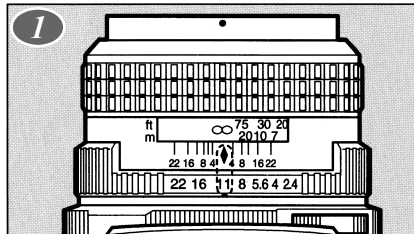

Set the lens aperture ring to the desired f-stop.

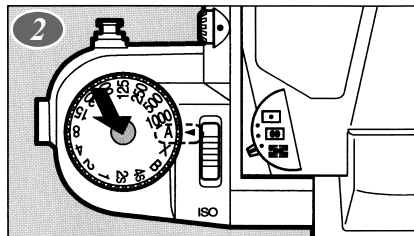

Turn the shutter speed dial to **A** while holding down the shutter speed dial lock button.

- See page 49 for the Metered Manual Mode.
- The Aperture-Priority AE Mode does not operate unless the AE Pentaprism Finder 67 II is attached.
- When the shutter speed dial is set to **A** without attaching the AE Pentaprism Finder 67 II, the shutter speed will be set at 1/30 of a second.

Using the Multi (6)-Segment Metering Mode

In the Multi (6)-Segment Metering Mode, the metering system automatically measures light in six different zones, enabling proper exposure value in a wide variety of normal and adverse lighting conditions.

- The Center-Weighted Metering Mode and Spot Metering Mode are also available in this camera. See page 55 and 56 for more details.
- When the lens is stopped down, the exposure metering mode is set to Center-Weighted Metering Mode even if the metering mode selector is set to Multi (6)-Segment Metering Mode.

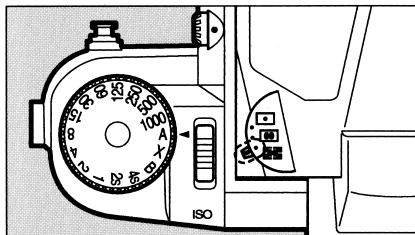

Set the metering mode selector to .

 is displayed in the viewfinder.

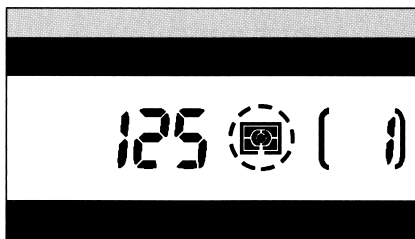

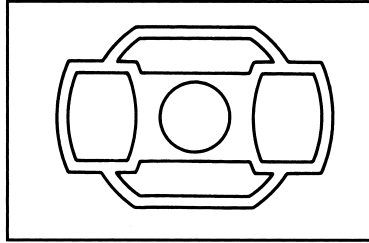

Multi (6)-Segment Metering

This camera incorporates a high-precision six-segment TTL metering system. Light values are measured in six segments within the image field, enabling an optimal exposure to be made under a variety of lighting conditions. With conventional

averaged metering systems, underexposure of the subject results from the brightness of the background affecting the overall metering. With multi (6)-segment metering, the camera records the brightness in six zones within the image field and uses these measurements to choose an exposure that will not underexpose the subject. The multi (6)-segment metering system also calculates exposure values for a scene to automatically compensate for high-contrast and other difficult lighting conditions. Even a beginner can achieve excellent results with ease.

Holding the Camera

- To reduce the camera shake, support your body or the camera on a solid object- a table, tree, or a wall for instance.
- When using an ultra-telephoto lens, a tripod that is heavier than the total weight of the camera and lens is recommended to avoid the camera shake.

Camera held horizontally

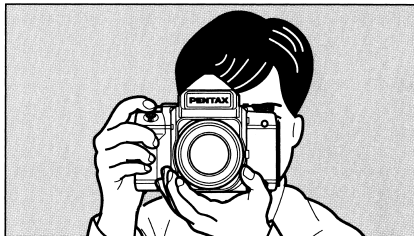

Camera held vertically

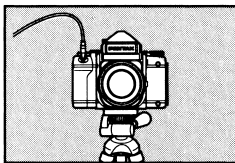

For best results, be sure to hold the camera correctly as shown in the illustrations.

Hold the camera firmly, with your left hand supporting the camera and lens as shown in the illustrations. While taking a picture, hold your breath and gently depress the shutter release button. (Sudden force on the shutter release button will cause camera shake, making the picture blurred.)

Although there are individual differences among photographers, in general the shutter speed for a hand held camera is the inverse of the focal length. For example, $1/75$ of a second when the focal length is 75 mm, and $1/150$ of a second when it is 150 mm. A tripod should be used for shutter speeds slower than this. When the tripod is used, use of an optional Cable Release is recommended.

Taking a Picture

- Adjust the diopter before use if the view from the viewfinder is not clear. See page 33.
- An interchangeable focusing screen is available. See page 70.

The viewfinder appears as illustrated below. You can use ① or ② for focusing.

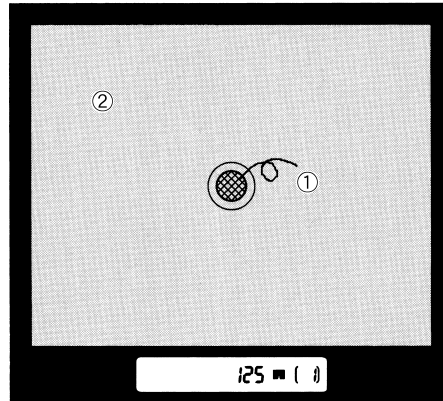

① Microprism field

Turn the focusing ring until the image on the microprism appears sharp and crisp.

② Matte field

Turn the focusing ring until the image on the matte field appears sharp and crisp.

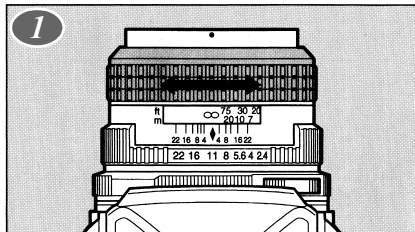

While looking through the viewfinder, turn the focusing ring to the right or left until the image appears sharp and crisp.



In focus

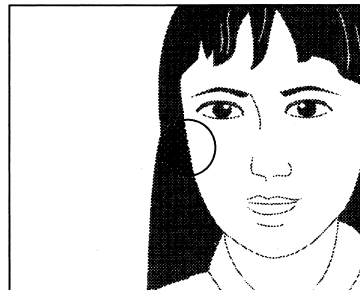

Out of focus

- You can also display the indicators in the viewfinder by pressing the memory lock button **ML** instead of depressing the shutter release button halfway down. This is useful when you are using a Cable Release. However, if you press the memory lock button **ML** in the Aperture-Priority AE Mode, the memory lock function is set. Press the memory lock button **ML** again before taking a picture.

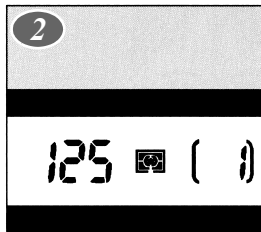

Depress the shutter release button halfway down. The shutter speed and film counter indicator are displayed in the viewfinder.

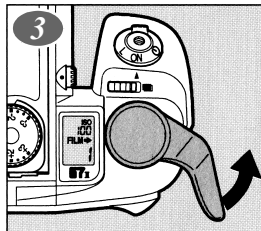

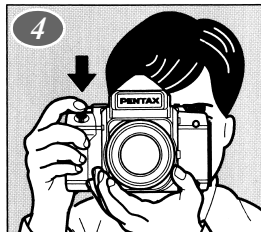

Cock the shutter.

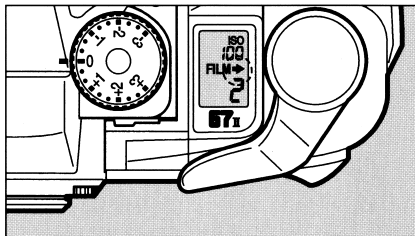

Depress the shutter release button fully.

- Do not try to cock the shutter when  is not displayed on the LCD panel.



When the shutter is in the uncocked position, the film advance indicator  appears on the LCD panel.

Using the Self-Timer Mode

The Self-Timer Mode delays the shutter release, and is useful for taking group shots that include the photographer. The shutter will be released about 12 seconds after the shutter release is depressed.

- When the self-timer is in operation, the audible PCV signal is heard and the rate increases for the last two seconds.
- To cancel the self-timer operation after it has been activated, move the main switch to **ON** or **L**.

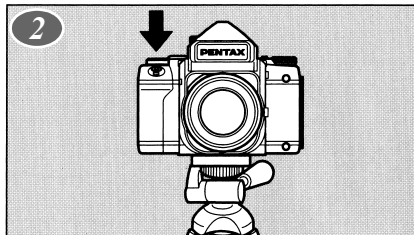
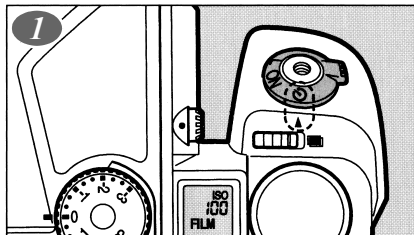

Set the main switch to .

Focus on the subject and then depress the shutter release button fully.

Eyepiece Shutter

- In normal photography, set the eyepiece shutter to the up position.

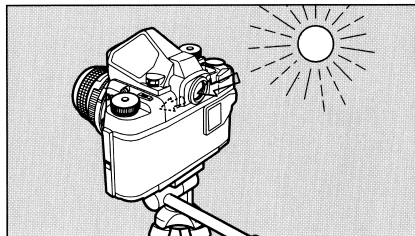
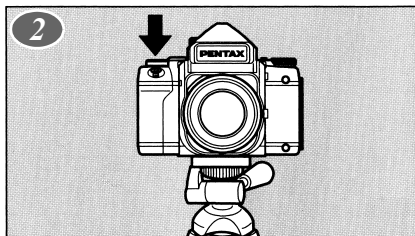
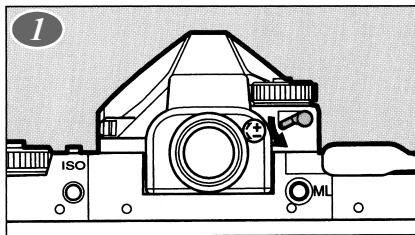

When using the camera in a situation where your eye will not remain at the viewfinder when taking the picture, such as when using the Self-Timer Mode, set the eyepiece shutter to the down position.

Depress the shutter release button.

Eyepiece Shutter

When using the camera in a situation where your eye will not remain at the viewfinder when taking the picture, such as when using the Self-Timer Mode, stray light may enter the viewfinder causing an incorrect exposure. Using the eyepiece shutter will block any stray light, assuring a proper exposure.

Multiple-Exposure Mode

You can take trick pictures by overlapping multiple shots on one frame using the Multiple-Exposure Mode.

- Operate the multi-exposure lever before you cock the shutter. Otherwise, the frames may be misaligned.
- The frames may be misaligned if you take a picture in the Multiple-Exposure Mode.
- When the film is wound halfway, you can release a finger from the multi-exposure lever. The lever stays in the lock position and the film counter indicator blinks.

Next page ➡➡

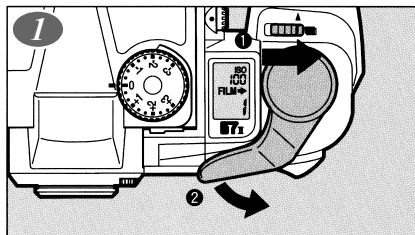

After taking the first picture as normal, move the multi-exposure lever in the direction of the arrow. Cock the shutter while holding down the lever.

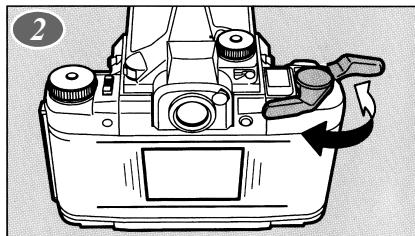

The film does not advance at this stage, so the second shot will be imposed on the previous shot.

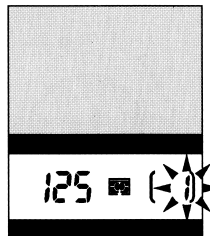
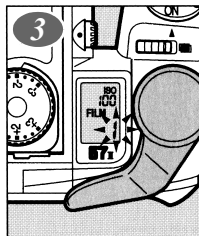

The film counter indicator in the viewfinder and on the LCD panel blinks when the wind lever is set back to its original position.

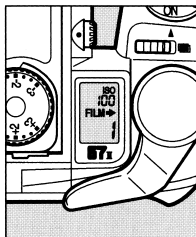
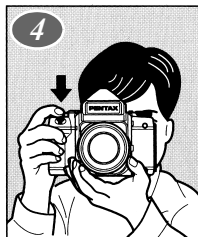

Depress the shutter release button. The film counter indicators in the viewfinder and on the LCD panel stop blinking.



- To expose the third shot, set the multi-exposure lever in the lock position in the same manner as step 1 after taking the second shot.
- When using the Multi-Exposure Mode, you usually get the best results using a flash to illuminate the main subject against a dimly-lit background.
- Once the Multi-Exposure Mode is set, it cannot be canceled normally. If you want to cancel it, cover the lens with the cap, set the shutter speed to 1/1000 of a second, set the aperture to the minimum value, and depress the shutter release button in a dark place.
- When making the multi-exposures on the last frame of the film,  appears on the LCD panel after the first-exposure is made and then [10] or [21] appears when the shutter is cocked for second exposure while holding down the multi-exposure lever.

Selecting an Exposure Mode

Using the Aperture-Priority AE Mode

When the desired aperture is selected, the camera automatically selects an appropriate shutter speed for a proper exposure.

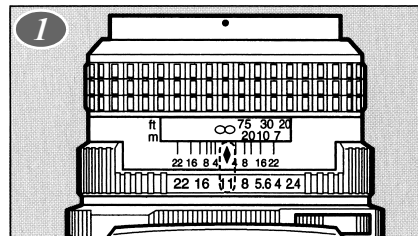

Set the lens aperture ring to the desired f-stop position.

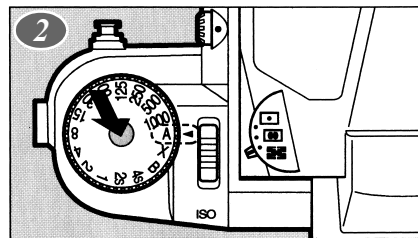

Turn the shutter speed dial to **A** while holding down the shutter speed dial lock button.

- The shutter speed dial can be released from **A** to another position while holding down the shutter speed dial lock button.
- The Aperture-Priority AE Mode does not operate unless the AE Pentaprism Finder 67 II is attached.

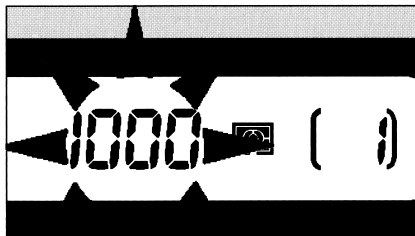
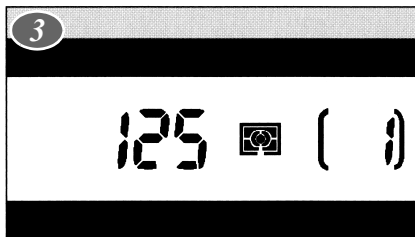

When the shutter release button is depressed halfway down, the shutter speed, the metering mode, and the film counter indicator will be displayed in the viewfinder.

Exposure Warning

If the subject is too bright or too dark, the selected shutter speed will blink in the viewfinder as a warning as shown. When the subject is too bright, choose a smaller aperture; and when it is too dark, choose a larger aperture. When the shutter speed indicator stops blinking, you can take a picture. If the shutter speed indicator does not stop blinking, it means that the exposure is out of metering range, unable to obtain a correct exposure even if the aperture is adjusted. Use a ND filter or select a darker subject if the subject is too bright or use a flash if it is too dark.

Using the Metered Manual Mode

The Metered Manual Mode is a convenient exposure mode for taking pictures using the same shutter speed and aperture setting combination, or taking creatively under or over exposed photographs.

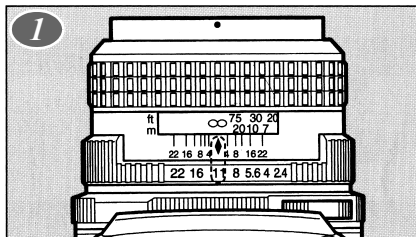

Set the lens aperture ring to the desired f-stop setting.

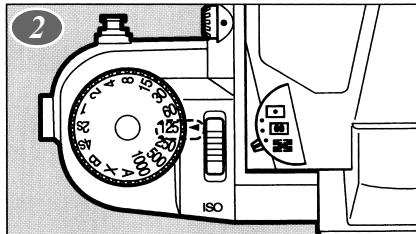

Set the shutter speed dial to a desired shutter speed other than **A**.

- To set the shutter speed dial to \boxed{X} or a position other than \boxed{A} , turn the shutter speed dial while holding down the shutter speed dial lock button.

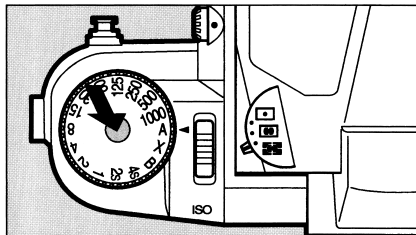

To set the shutter speed dial to a position other than \boxed{A} , turn the shutter speed dial while holding down the shutter speed dial lock button.

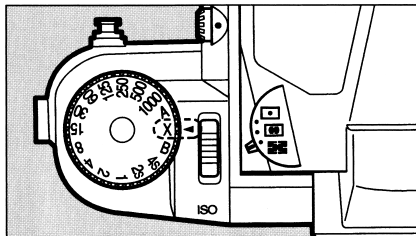

In flash photography, when you use the flash sync shutter speed of 1/30 of a second or a non-dedicated external flash unit, set the shutter speed dial to the \boxed{X} (1/30 of a second) position.

- When the bars are displayed above the ☉ side on the bar graph, it indicates overexposure and when the bars are displayed above the ☾ side, it indicates underexposure. When a single bar is displayed in the center of the bar graph, it indicates correct exposure. Moving one bar above the bar graph indicates 0.3 step (0.3EV). However, when over or under exposure is set beyond +3 or -3 steps (3EV), ☉ or ☾ indicator will blink.
- The bar graph in the view finder is displayed only when the AE Pentaprism Finder 67 II is attached.

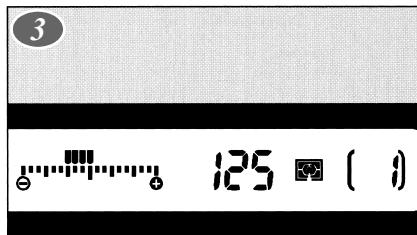

When the shutter release button is depressed halfway, the shutter speed and bar graph (the illustration indicates -1EV), the metering mode and the film counter indicator will be displayed in the viewfinder.

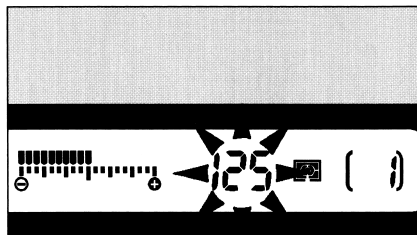

Exposure Warning

If the subject is too bright or too dark, the selected shutter speed will blink in the viewfinder as shown. It means that the exposure is out of metering range, unable to obtain a correct exposure even if the shutter speed or aperture is adjusted. Use a ND filter or select a darker subject if the subject is too bright or use a flash if it is too dark.

Using the Bulb Exposure Mode

This mode is useful for the long exposures required for shooting night scenes and fireworks. The shutter remains open as long as the shutter release button is held down.

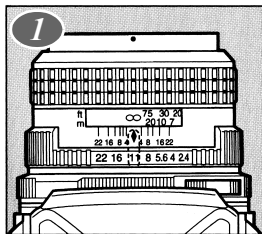

Set the lens aperture ring to the desired f-stop.

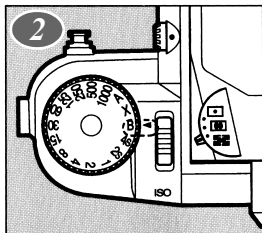

Set the shutter speed dial to **B**.

bu will be displayed in the viewfinder when the shutter release button is depressed halfway.

- The indicators in the viewfinder can be light up by depressing the Cable Release halfway.
- See page 15 for the bulb exposure time when a new battery is used.

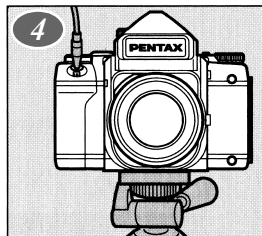
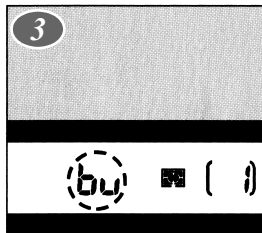

In the Bulb Exposure Mode, use a steady tripod to prevent camera shake and attach the optional Cable Release.

About Exposure Compensation

Exposure compensation allows you to deliberately overexpose (brighten) or underexpose (darken) a subject, or to compensate for difficult lighting conditions which may fool the camera's built-in exposure meter.

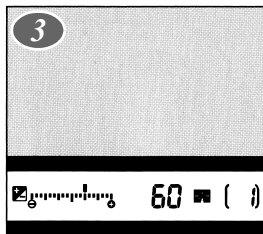
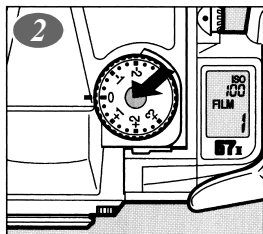
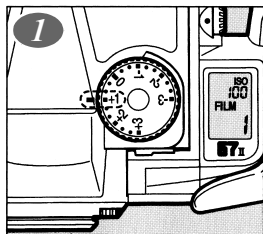

- Exposure compensation does not work in the Bulb Exposure Mode.
- The exposure compensation range is -3EV to $+3\text{EV}$ in 0.3EV step.
- Moving one bar above the bar graph indicates a 0.3EV step.



Turn the exposure compensation dial to the desired compensation value.

To set the exposure compensation dial to a position other than the 0 position, turn the exposure compensation dial while holding down the exposure compensation dial release button.

The bar graph indicates the compensation value and  appear in the viewfinder.

- When exposure compensation is used in the Metered Manual Mode, the bar above the bar graph indicates the value of under or over exposure and  is displayed instead of the bar graph showing the compensation value in the viewfinder. You can take pictures with the compensation value you set by setting  to the center of the bar graph.

Switching the Metering Mode

The Spot Metering Mode or Center-Weighted Metering Mode can also be selected in this camera.



Select the desired metering mode with the metering mode selector.

- These metering systems do not automatically compensate for back lighted or spotlighted scenes like the Multi (6)-Segment Metering Mode. Creative exposure control is determined by the user.

Using the Center-Weighted Metering Mode

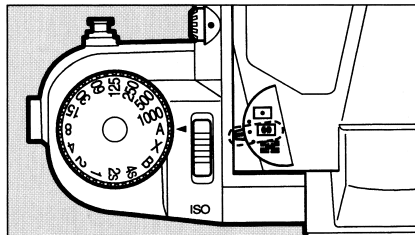
The Center-Weighted Metering Mode is an orthodox metering system.



Set the metering mode selector to the  position.  is displayed in the viewfinder.

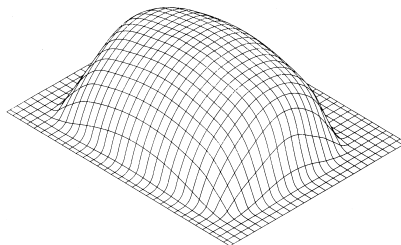



The metering pattern in the illustration on the left shows that the upper part of the pattern (in the center of the viewfinder) has more sensitivity to light than the lower part.

Using the Spot Metering Mode

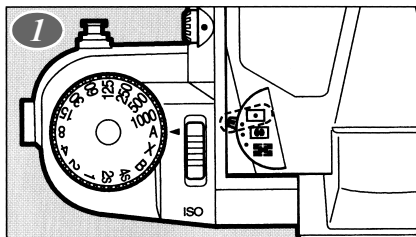
The Spot Metering Mode measures light only in the small area in the center of the viewfinder.



Set the metering mode selector to the  position.  is displayed in the viewfinder.

- If the brightness range between the center of the picture and the surrounding areas is too great, the exposure should be determined in consideration of the overall brightness. Otherwise, the picture will come out improperly exposed.

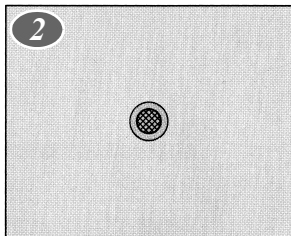

Measure with the small area of the viewfinder as illustrated.

Using the Memory Lock Function

The memory lock function enables an exposure level to be memorized before shooting. The memory lock function is very effective when used along with spot metering. Use memory lock function to get a correct exposure when the subject occupies only a small part of the viewfinder.

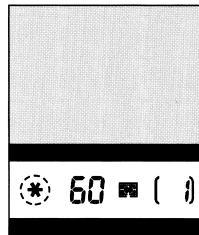
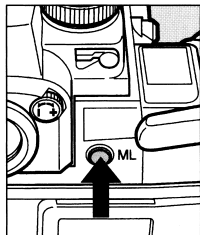

Depress the memory lock button **ML**. The exposure level is memorized and ***** is displayed in the viewfinder.

- As soon as the memory lock button **ML** is depressed, the camera stores the measured exposure level for 20 seconds even if the memory lock button **ML** is released.
- If the shutter release button is depressed halfway down while the memory lock timer is operating, the memorized meter reading will remain even if the memory lock button **ML** is released.
- To cancel the memory lock function, depress the memory lock button **ML** again.
- The memory lock function cannot be used when the camera is set in the Metered Manual Mode.
- The memory lock function will be canceled after a picture is taken.

Using a PENTAX Dedicated External Flash

Using the TTL Auto Flash

Compatible flash units are AF540FGZ, AF360FGZ, AF500FTZ, AF400FTZ, AF330FTZ, AF240FT, AF280T, AF200T and AF220T.

* To use above flash units, an optional hot shoe grip 67 II is required.

- 1 Attach the hot shoe grip 67 II to the camera.
- 2 Remove the black cover (hot shoe cover Fc) on the upper part.
- 3 Attach a Pentax dedicated flash unit to the hot shoe grip 67 II.
- 4 Connect the cord to the camera's 5P-sync terminal.

- To attach a hot shoe grip 67 II to the camera, refer to the operating manual of hot shoe grip 67 II.
- In the Aperture-Priority AE Mode or when the shutter speed is set in the range of 1/30 to 1/1000 of a second, the flash sync speed of 1/30 of a second is set when the flash is fully charged.
- When the shutter release button is depressed halfway down,  appears in the viewfinder and on the LCD panel when the flash is fully charged.
- In the Aperture-Priority AE Mode, when the flash is fully charged, the Metered Manual Mode is automatically set. The bar graph indicates the exposure value for the background. See page 51 for the bar graph.
- For more details, read the flash's operating manual.
- Power the flash after connecting the cord.

Using the AF400T Flash Unit

* To attach the AF400T flash unit to the 67 II camera, an optional bracket for AF400T and 4P sync cord A are required.

- 1 Attach the AF400T to the camera using the AF400T 67 II Bracket.
- 2 Connect the 4P sync cord A to the X-sync terminal.

- To attach a bracket for AF400T to the 67 II camera, refer to the operating manual of AF400T 67 II Bracket.
- In the Aperture-Priority AE Mode or when the shutter speed is set in the range of 1/30 to 1/1000 of a second, the flash sync speed of 1/30 of a second is set when the flash is fully charged.
- When the shutter release button is depressed halfway down,  appears in the viewfinder and on the LCD panel when the flash is fully charged.
- In the Aperture-Priority AE Mode, when the flash is fully charged, the Metered Manual Mode is automatically set. The bar graph indicates the exposure value for the background. See page 51 for the bar graph.
- For more details, read the flash's operating manual.
- The AF200T and AF280T can be used in the same way as the AF400T by combining it with an optional hot shoe grip. For more details, read the AF400T 67 II Bracket operating manual.
- Power the flash after connecting the cord.

Exposure Compensation with the TTL Flash Unit

If the exposure compensation is combined with the TTL flash unit, only the amount of flash is adjusted. The brightness of the background and the amount of flash can be adjusted simultaneously by setting  to the center of the bar graph.

Using External Metering Auto Flash

Two- or three-level auto flash modes are available with AF200T, AF280T, and AF400T.

When using the two- or three-level auto flash modes (red and green, or red, green and yellow settings), set the aperture value as shown in the table. In the Aperture-Priority AE Mode or when the shutter speed is set in the range of 1/30 to 1/1000 of a second, the flash sync speed of

1/30 of a second is set when the flash is fully charged.

	AF200T	AF280T	AF400T
Red	f/2.8	f/4	f/4
Green	f/5.6	f/8	f/8
Yellow			f/11

with ISO 100

Multi-Burst Flash with the Pentax Dedicated Flash

When discharging more than two Pentax dedicated flashes, make sure that they are of the same type, the combination of Type A and B or Type C and D (refer to the overview of Flash Function on page 62).

AF540FGZ, AF500FTZ, AF330FTZ and AF360FGZ

- In the Aperture-Priority AE Mode or when the shutter speed is set in the range of 1/30 to 1/1000 of a second, the flash sync speed of 1/30 of a second (1/15 of a second in the trailing-shutter-curtain sync flash and contrast-control flash modes) is set when the flash is fully charged.
- The auto zoom function does not function with this camera. Adjust the focal length manually.
- A wireless slave-sync flash function is available when using the AF500FTZ and AF360FGZ together.
- Multiple-burst flash is possible with the AF500FTZ.
- When the flash is charged and left unused for about three minutes, the power automatically switches off to save battery power. Depressing the shutter release button halfway will restart charging of the flash units.

AF240T and AF400FTZ

- In the Aperture-Priority AE Mode or when the shutter speed is set in the range of 1/30 to 1/1000 of a second, the flash sync speed of 1/30 of a second is set when the flash is fully charged.
- When the flash is charged and left unused for about five minutes, the power automatically switches off to save battery power. Depressing the shutter release button halfway will restart charging of the flash units.

AF200T, AF280T and AF400T

- The two- or three-level auto flash mode can be used in addition to the TTL auto flash.
- In the Aperture-Priority AE Mode or when the shutter speed is set in the range of 1/30 to 1/1000 of a second, the flash sync speed of 1/30 of a second is set when the flash is fully charged.

Overview of Flash Function

CAMERA FUNCTION	TYPE A	TYPE B	TYPE C	TYPE D
After the flash is charged, the camera automatically switches to the flash-sync speed (1/30 of a second).	○	○	○	○
Flash confirmation signal in the viewfinder and LCD panel	○	○		
TTL auto flash	○	○	*1 ○	
Slow-speed sync in the Metered Manual Mode	○	○	○	○
Trailing-shutter-curtain sync flash*2	○	○		
Contrast-control flash mode*2	○			

TYPE A : AF540FGZ, AF500FTZ*3, AF330FTZ, AF360FGZ

TYPE B : AF400FTZ, AF240FT

TYPE C : AF400T, AF280T, AF220T, AF200T, AF201SA,
AF200SA

TYPE D : AF200S, AF160, AF140

*1 : The AF200SA and AF201SA do not operate.

*2 : The shutter speed is 1/15 or slower.

*3 : Multi-burst and slave-sync flash are possible.

Using other types of flash

- Use of non-Pentax flash units may damage the camera. For the best results, use a Pentax dedicated flash unit.
- Some large studio type flashes may have inverted contacts, and will therefore not fire when attached to a 67 II camera. For further information, contact the flash unit manufacturer. To prevent the view from being vignetted by the second shutter curtain, it is recommended that you use a shutter speed one step slower than the flash sync speed.
- The secondary functions do not work when the cord is connected to the X-sync terminal only.

Slow-Speed-Sync Shooting

It is possible to balance the exposure of a foreground subject against a dimly lit background by using the flash to properly expose the foreground subject and a slow-shutter-speed to expose the low light background.

- The operation in step **1** can be performed at any time before taking a picture.
- In the slow-speed-sync shooting, use of a tripod is recommended to prevent camera shake.

- 1** Set the camera's exposure mode to the Metered Manual Mode.
- 2** Turn the flash on.
- 3** Select an appropriate shutter speed (slower than 1/30 of a second) and aperture combination for a correct exposure.
- 4** Release the shutter.

Checking the Depth-of-Field

- The actual range in focus and the depth of field confirmed through the viewfinder may differ to some degree.
- When the depth-of-preview lever is set at the **MAN** position, the metering mode selector moves to the Center-Weighted Metering Mode automatically.

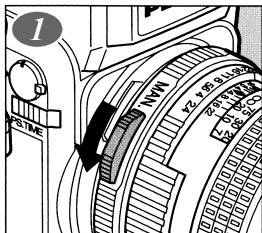

Slide the depth-of-preview lever on the lens until the letters **MAN** appears.

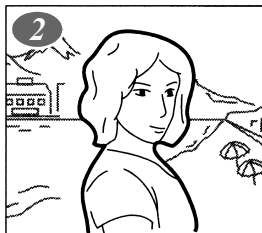

The aperture will stop down to the preset value, and the depth of field can be confirmed through the viewfinder.

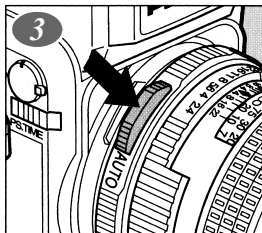

The lever will be returned to the original position by depressing the depth-of-preview lever.

Mirror Lock-Up

Locking the mirror in the lock-up position helps to minimize the camera vibrations that may contribute to blurred pictures.

- With the mirror in the locked-up position, the memory lock function automatically operates and the exposure is fixed.
- Mirror lock-up does not operate before winding the film.
- Once the mirror lock-up is set, it cannot be canceled normally. If you want to cancel it, depress the shutter release button in a dark place and perform the same operation as with the Multiple Exposure Mode.
- When the battery is exhausted, this function does not operate. Locking the mirror continuously also makes the battery become exhausted more rapidly.

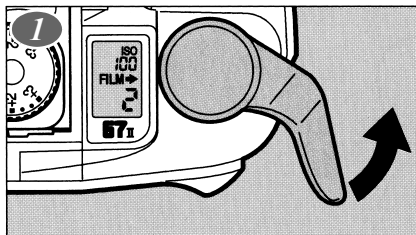

Wind the film.

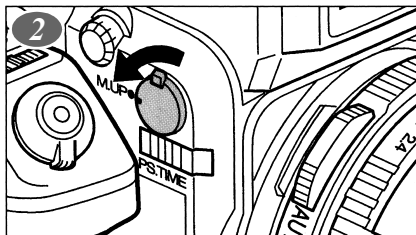

Slide the mirror lock-up lever upward. The mirror goes up and stays in the up position.

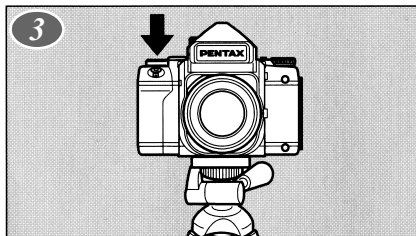

Release the shutter.

Time Exposure Mode

In the Time Exposure Mode, the battery consumption is extremely minimized to save the batteries. This mode is useful for the long exposures required for shooting night scenes and astronomical photography.

- The time exposure set lever can be set after the film is winded.
- When the battery is exhausted, this function does not operate.

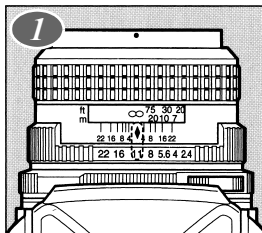

Set the lens aperture ring to the desired f-stop.

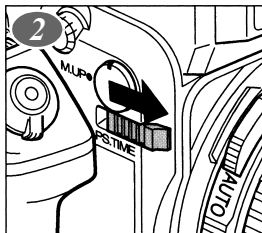

Slide the time exposure set lever as shown in the illustration.

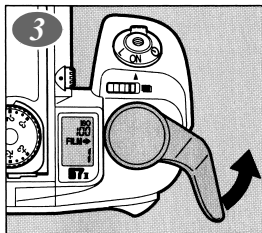

Wind the film.

- The shutter will not close until the time set with the dial lapses, regardless of the shutter dial position and the position of the time exposure set lever.
- The Time Exposure Mode can be combined with the mirror lock-up function.

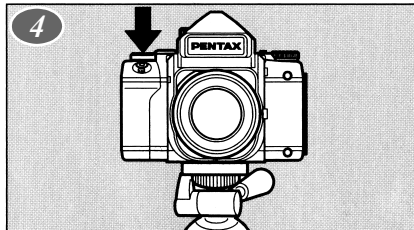

Depress the shutter release button. The shutter remains open.

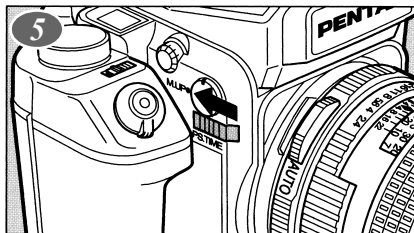

Slide the time exposure set lever to the original position. The time exposure finishes.

Infrared Index

When infrared film and an "R2" or "O2" filter are used, the focal point is different from that of ordinary film exposed in visible light. Focus on a subject in the following manner.

- To set the proper exposure level for infrared pictures, refer to the instructions accompanying the film. The Aperture-Priority AE Mode does not give a correct exposure for infrared film. Use the Metered Manual Mode.

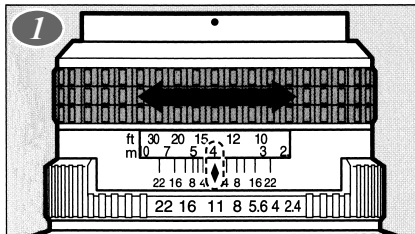

Focus on a subject as usual and memorize the focusing point on the lens distance scale.

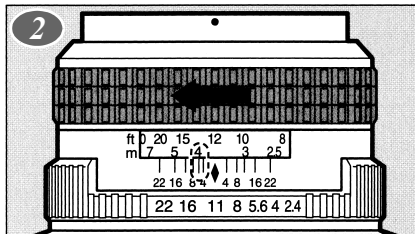

Turn the focusing ring to the left until the point you memorized aligns with the infrared index.

Accessories (Optional)

A number of dedicated accessories are available for this camera. For further information, contact your local Pentax local service center.

● **Cable Release 30 and 50**

A shutter release cable designed for use with the camera equipped with threaded cable release socket.

● **Magnifier 67**

A viewfinder accessory for magnifying the central area of the viewfinder.

● **Refconverter 67**

Right angle finder which attaches to the eyepiece of either the AE Pentaprism Finder 67 II or Pentaprism Finder 67 II. The viewfinder can be switched vertically and horizontally.

● **Filters**

Skylight, Cloudy, UV, Y2, O2, R2, and Circular Polarizing Filters are available.

● **Auto Flash AF540FGZ**

This is an auto flash unit with a maximum guide number of 54 (at ISO/100m). Its features include slave-sync flash, contrast-control-sync flash, programmed auto flash, high-speed sync, wireless flash and leading/trailing shutter-curtain sync.

● **Auto Flash AF360FGZ**

This is an auto flash unit with a maximum guide number of 36 (ISO 100/m). Its features include slave-sync flash, contrast-control-sync flash, AF spot beam, high-speed sync, wireless flash and leading/trailing-shutter curtain-sync.

● **Hot shoe grip 67 II**

This grip allows the AF500FTZ, AF330FTZ, AF240FTZ, and AF400FTZ to be used off the camera, while maintaining the full electronic coupling to the camera.

● **Hot Shoe Adapter FG, Extension Cord F5P, Off-camera Shoe Adapter F**

Use the adapters and cords to use the external flash away from the camera.

● **AF400T Bracket for 67 II**

Attaches AF400T flash unit to a 67 II camera via tripod socket on the base of the camera.

● **QS-20 Quick Shoe Adapter/QS-B1 Quick Shoe Base**

An accessory to enable quick attachment and detachment of the camera from a tripod.

● Interchangeable Focusing Screen

Twelve types of focusing screens including the standard focusing screen are available.

Refer to the chart on page 71 for the combination of screens according to camera. Refer to instruction sheets supplied with each screen for changing instructions.

BA-61, BA-81 (Microprism Matte)

For general use. Matte screen with microprism.

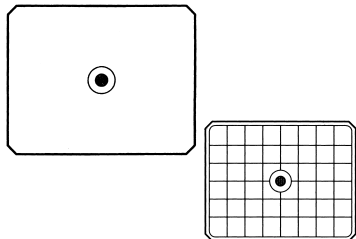

BH-61, BH-81

(Cross-Lined Microprism Matte)

Designed to guide picture compositions.

BB-61, BB-81 (Split-Image Matte)

Matte screen with split image.

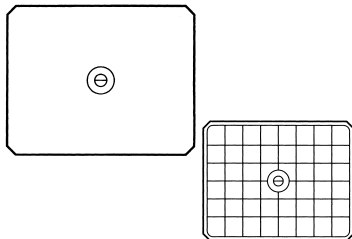

BJ-61, BJ-81

(Cross-Lined Split Image Matte)

Designed to guide picture compositions.

BE-60, BE-80 (Center-Spot Matte)

The standard focusing screen for general photography.

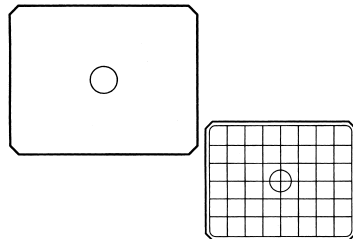

BG-60, BG-80

(Cross-Lined Matte)

Designed to guide picture compositions.

- BA-61, BB-61, BE-60, BG-60, BH-61 and BJ-61 can be used for any focal length of the lens. BA-81, BB-81, BE-80, BG-80, BH-81, and BJ-81 are bright focusing screens designed for use with the telephoto lenses or the slower maximum aperture lenses. However, the exposure accuracy of these focusing screens may decrease when the lens is stopped down. Also, when used in combination with a rear converter, a slight amount of overexposure will occur. For more information, read the operating manual of 67 II Interchangeable Focusing Screens.

Lenses \ Screens	BA-61/BB-61 BH-61/BJ-61	BE-60 BG-60	BA-81/BB-81 BH-81/BJ-81	BE-80 BG-80
SMC PENTAX FISH-EYE 35mm/4.5	○	○	△	△
SMC PENTAX 45mm/4	○	○	△	△
SMC PENTAX 55mm/4	○	○	△	△
SMC PENTAX 75mm/2.8 AL	○	○	△	△
SMC PENTAX 75mm/4.5	○	○	△	△
SMC PENTAX 90mm/2.8	○	○	○	○
SMC PENTAX 105mm/2.4	○	○	○	○
SMC PENTAX 165mm/2.8	○	○	○	○
SMC PENTAX 200mm/4	○	○	○	○
SMC PENTAX M* 300mm/4 ED(IF)	○	○	○	○
SMC PENTAX 300mm/4	○	○	○	○
SMC PENTAX M* 400mm/4 ED(IF)	○	○	○	○
SMC PENTAX 500mm/5.6	○	○	◎	◎
SMC TAKUMURA 600mm/4	○	○	○	○
SMC TAKUMURA 800mm/4	○	○	○	○
SMC PENTAX M* 800/6.7 ED(IF)	▲	○	▲	◎
SMC REFLEX TAKUMURA 1000mm/8	▲	○	▲	◎
SMC PENTAX MACRO 100mm/4	○	○	◎	◎
SMC PENTAX MACRO 135mm/4	○	○	◎	◎
SMC PENTAX SHIFT 75mm/4.5	▲	○	▲	△
SMC PENTAX SOFT 120mm/3.5	○	○	○	○
SMC PENTAX LS 165mm/4	○	○	○	○
SMC PENTAX 55-100mm/4.5	○	○	△	△
SMC PENTAX 90-180mm/5.6	○	○	△	△

◎ : Especially compatible

○ : Compatible

△ : The corners of viewfinder are darkened

▲ : The split-image and micropism areas are darkened

Caution

Telephoto screens make the viewfinder brighter, facilitating focusing even with the slower maximum aperture lenses. However, care must be taken as the brightness of the screen may affect the exposure.

Notes on Accessories

- When using the AE Pentaprism Finder 67 II or Pentaprism Finder 67 II in conjunction with the magnifier or eyecup, detach the rubber ring from the finder's eyepiece. If the eyepiece from which the rubber ring was detached is squeezed too tightly, it may be difficult to detach the ring. In this case, hold down and rotate the frame of the eyepiece using the back side of the strap (the side without the word PENTAX on it) to make it easier to detach the ring.
- When using an ordinary polarizing filter, exposure accuracy can be adversely effected. The use of a circular polarizing filter is necessary for proper exposure.
- If you are using the auto close-up ring in the Aperture-Priority AE Mode, make sure to narrow the aperture before taking a picture. Otherwise, the exposure will not match.

Rear Converter

- When the Rear Converter is used with the focusing screen for telephoto lens installed (BA-81, BB-81, BE-80, BG-80, BH-81 or BJ-81), a slight amount of overexposure will occur.

Autobellows

- The autobellows without the extension tube (Outer bayonet No.1) cannot be attached to the 67 II camera if the AE Pentaprism 67 II is used. The extension tube (Outer bayonet No.1) and the scale (Scale 67 II) are available as an optional accessory.



No.1

Aperture and Shutter Speed Effects

Deciding the appropriate exposure for an object that you want to photograph (the subject) is all about deciding the right combination of shutter speed and aperture value. However, even for subjects with the same brightness, there are several combinations of shutter speed and aperture value possible. Depending on which combination you select, the effects of the picture differ.

The Effect of Shutter Speed

The shutter speed adjusts the amount of light that is exposed to the film by lengthening or shortening the length of time the film is exposed to the light.

If the shutter speed is slow, the shutter is open for a long amount of time, and if the subject that you want to photograph at this time is moving, the subject will naturally become blurred. On the other hand, if the shutter speed is fast, even if the subject is moving, the camera is able to take a picture as though the subject is stationary. Setting a fast shutter speed can also prevent pictures from blurring due to the camera shaking when you press the shutter. Also, if you take pictures of rivers, waterfalls, waves, etc., at a low shutter speed, they will turn out as pictures with a motion-like quality.



Fast Shutter Speed



Slow Shutter Speed

ADVANCED OPERATION

The Effect of Aperture

Aperture refers to adjusting the amount of light that hits the film, by widening or narrowing the beam, or “thickness” of light that passes through the lens.

If the aperture is opened, thus widening the beam of light, the objects in front of and behind the subject in focus are blurred. In other words, the focus range becomes smaller. On the other hand, by narrowing the aperture and thus narrowing the beam of light, the focus range becomes larger.

For example, when taking a picture of a subject against a background, if you widen the aperture and you take a picture, the areas other than the subject focused on become blurrier, making the subject appear to be in the foreground. On the other hand, by narrowing the aperture, it is possible to keep the background areas in focus.



Narrowed Aperture



Opened Aperture

Custom Function

The Pentax 67 II offers “Custom Functions” to modify the camera’s operation to suit personal preferences. Modifications are made at a Pentax service center (at some charge).

Please consult your local Pentax service center for details.

(1) 1/2 EV Shutter-speed settings

Shutter speeds can be divided into 1/2 EV steps.

(2) Metering timer duration

The 10-second metering timer can be changed to 5, 20 or 30 seconds. In memory lock mode, the timer is changed from initial 20 seconds to 10, 40, or 60 seconds.

(3) F-number indication in viewfinder display

The selected aperture is displayed in the viewfinder LCD indicator instead of exposure frame number. This Custom Function is available only when a lens with automatic diagram control is mounted.

(4) Installment of an additional strap lug

An additional strap lug is installed next to the grip for horizontal positioning of the camera.

Precautions Regarding Custom Functions

- For modification (3), if f-stops are displayed in the viewfinder, then the film number is not displayed.
- For (3), the f-stop is not displayed if the lens or accessories do not support photometry.
- For (3), the f-stop displayed in the viewfinder does not necessarily match with the aperture set with the lens.

Troubleshooting

What appears troublesome may be easily remedied. Here are some problems that may occur and their remedies. Before contacting a Pentax service center, check the following items.

Symptoms	Causes	Remedies	Reference
The shutter cannot be released.	The last frame is exposed.	Remove the film.	Page 31
	The main switch is set to L .	Set the main switch to ON .	Page 16
	The low battery warning  appears.	Replace the batteries.	Page 14
	The Self-Timer Mode is set.	Cancel the Self-Timer Mode.	Page 43
	The film is not winded.	Wind the film.	Page 41
Indicators do not appear on the LCD panel.	The main switch is set to L .	Set the main switch to ON .	Page 16
	No batteries have been installed.	Install the batteries.	Page 14
	The batteries are improperly installed.	Install the batteries properly.	Page 14
	The batteries are dead.	Replace the batteries.	Page 14
Focus is not precise in the picture.	The pressure plate has not been set to the proper position.	Set the pressure plate according to the film type.	Page 25
Film winding is very heavy.	The pressure plate has not been set to the proper position.	Set the pressure plate according to the film type.	Page 25
The first frame (or the last frame) was cut off on the film.	The film start mark had not been properly set.	Set the film start mark to the proper position.	Page 25

Symptoms	Causes	Remedies	Reference
The view from the viewfinder is not clear.	The diopter is not adjusted.	Adjust the diopter.	Page 33
The spool does not turn when winding the film.	No batteries have been installed.	Install the batteries.	Page 27











Error Display in the Event of Incorrect Operation

In the event of unusual operation of the camera, [E] followed by double figures, e.g. [E-13], will appear on the LCD panel to indicate an error. When this happens, the shutter cannot be released. In this event, follow the instructions below.

If the first figure after [E] is "1" or "3"	This indicates camera breakdown, irrespective of the second figure. You should take the camera to your local Pentax service center.
If the second figure after [E] is "1", "2" or "3"	If there is a film in the camera, wind to the end and remove the film. Press the shutter and if the error display disappears, the camera is ready for use. We recommend, however, that you have the camera checked at your local Pentax service center. If there is no film in the camera, open and close the back cover. If the error display disappears, the camera is ready for use.
If [PErr] is displayed	Take the viewfinder out and put it back two or three times. If the error display disappears, the camera is ready for use.

In rare cases, the camera may not operate correctly due to static electricity. This can be remedied by taking the batteries out and putting them back again.

Specifications

- Type** ————— 6 × 7 format SLR camera
- Format** ————— 55 × 70 mm
- Usable film** ————— 120 roll film (10 exposures), 220 roll film (21 exposures), ISO 6 to 6400
- Exposure modes** ——— Aperture-Priority AE Mode, Metered Manual Mode, Bulb Mode
- Shutter** ————— Electronically-controlled horizontal-run focal-plane shutter,
Speed range: Auto 1/1000-30 sec. (stepless), Manual 1/1000-4 sec.,
Bulb, X (1/30 of a second). Time Exposure Mode, Shutter lock by turning the
main switch to .
- Lens mount** ————— Pentax 67 double bayonet mount system (inner bayonet and outer bayonet)
- Viewfinder** ————— Interchangeable viewfinders (option), Focusing screen: Interchangeable screen with
Natural Bright-Matte focusing screen, Field of view: 90% vertical, Magnification: 0.75
× (with 105 mm lens at infinity), Diopter: -2.5 to +1.5 m⁻¹ (per meter)
- Viewfinder indicator** ——— Shutter speed indicator, Aperture indicator,  Flash status indicator, Bar graph:
Exposure compensation value indicator, Over or under exposure indicator in the
Manual Exposure Mode,  Exposure compensation indicator,  Memory lock
indicator, Film counter indicator,  Multi (6)-segment metering,  Center-
weighted metering,  Spot metering
- LCD panel indicator** ———  Low battery warning, Film speed, ISO indicator, Film counter,
 Film advance indicator,  Flash status indicator
- Self-timer** ————— Electronically-controlled type with delay time of 12 sec. (audible PCV signal),
Start by depressing shutter release button, Cancelable after operation

- Mirror** — Instant-return mirror with lock-up device
- Film winding** — With rapid wind lever (7 pre advance angle and 190 advance angle)
- Exposure meter** — TTL multi (6)-segment wide-open metering, Metering range from EV2 to EV21 at ISO100 with 105 mm f/2.4 lens in multi (6)-segment metering, Center-Weighted Metering Mode and Spot Metering Mode can be set
- Exposure compensation** — $\pm 3\text{EV}$ in 0.3EV step increments (With an optional AE Pentaprism 67 II attached)
- Multiple exposure** — Via multi-exposure lever
- Exposure memory lock** — With the memory lock button depressed, the memory timer locks the exposure value for 20 seconds. The memory lock function remains while the shutter release button is depressed halfway down. (With an optional AE Pentaprism 67 II attached)
- Flash sync** — Via 5P X-sync terminal for Pentax dedicated auto flashes, X-sync socket is provided for Pentax non-dedicated flashes, Flash Sync Speed: 1/30 sec, ISO range: 25-800
- Power source** — Two 3V lithium batteries (CR123A or the equivalent)
- Battery exhaustion warning** — Low battery warning  is lit (blinking when the shutter is locked; no indication in the viewfinder).
- Dimensions and weight** — 185.5 mm (W) \times 108.5 mm (H) \times 92 mm (D) (7.3" \times 4.3" \times 3.6"), 1210 g (42.7 oz), body only, without batteries and lenses
185.5 mm (W) \times 151 mm (H) \times 106 mm (D) (7.3" \times 5.9" \times 4.2"), 1660 g (58.6 oz), body with AE Pentaprism Finder 67 II attached without batteries and lenses
- Supplied accessories** — Body mount cap 67, Finder cap 67, LX sync terminal cap, 5P sync terminal cap, Strap G

WARRANTY POLICY

All PENTAX cameras purchased through authorized bona fide photographic distribution channels are guaranteed against defects of material or workmanship for a period of twelve months from date of purchase. Service will be rendered, and defective parts will be replaced without cost to you within that period, provided the equipment does not show evidence of impact, sand or liquid damage, mishandling, tampering, battery or chemical corrosion, operation contrary to operating instructions, or modification by an unauthorized repair shop. The manufacturer or its authorized representatives shall not be liable for any repair or alterations except those made with its written consent and shall not be liable for damages from delay or loss of use or from other indirect or consequential damages of any kind, whether caused by defective material or workmanship or otherwise; and it is expressly agreed that the liability of the manufacturer or its representatives under all guarantees or warranties, whether expressed or implied, is strictly limited to the replacement of parts as hereinbefore provided. No refunds will be made on repairs by non-authorized PENTAX service facilities.

Procedure During 12-month Warranty Period

Any PENTAX which proves defective during the 12-month warranty period should be returned to the dealer from whom you purchased the equipment or to the manufacturer. If there is no representative of the manufacturer in your country, send the equipment to the manufacturer, with postage prepaid. In this case, it will take a considerable length of time before the equipment can be returned to you owing to the complicated customs procedures required. If the equipment is covered by warranty, repairs will be made and parts replaced free of charge, and the equipment will be returned to you upon completion of servicing. If the equipment is not covered by warranty, regular charges of the manufacturer or of its representatives will apply. Shipping charges are to be borne by the owner. If your PENTAX was purchased outside of the country where you wish to have it serviced during the warranty period, regular handling and servicing fees may be charged by the manufacturer's representatives in that country. Notwithstanding this, your PENTAX returned to the manufacturer will be serviced free of charge according to this procedure and warranty policy.

In any case, however, shipping charges and customs clearance fees to be borne by the sender. To prove the date of your purchase when required, please keep the receipt or bills covering the purchase of your equipment for at least a year. Before sending your equipment for servicing, please make sure that you are sending it to the manufacturer's authorized representatives or their approved repair shops, unless you are sending it directly to the manufacturer. Always obtain a quotation for the service charge, and only after you accept the quoted service charge, instruct the service station to proceed with the servicing.

- This warranty policy does not affect the customer's statutory rights.
- The local warranty policies available from PENTAX distributors in some countries can supersede this warranty policy. Therefore, we recommend that you review the warranty card supplied with your product at the time of purchase, or contact the PENTAX distributor in your country for more information and to receive a copy of the warranty policy.



The CE Mark is a Directive conformity mark of the European Union.

An information on Disposal for users



1. in the European Union
If your product is marked with this symbol, it means that used electrical/electronic products should not be mixed with general household waste. There exists a separate collection system for these products.

Used electric/electronic equipment must be treated separately and in accordance with legislation that requires proper treatment, recovery and recycling of these products.

Following the implementation by member states, private households within the EU states may return their used electrical/electronic equipments to designated collection facilities free of charge*. In some countries your local retailer may also take back your old product free of charge if you purchase a similar new one.

*Please contact your local authority for further details.

By disposing of this product correctly you will help ensure that the waste undergoes the necessary treatment, recovery and recycling and thus prevent potential negative effects on the environment and human health which could otherwise arise due to inappropriate waste handling.

2. In other countries outside the EU

If you wish to discard this product, please contact your local authorities and ask for the correct method of disposal.

For Switzerland: Used electrical/electronic equipment can be returned free of charge to the dealer, even when you don't purchase a new product. Further collection facilities are listed on the home page of www.swico.ch or www.sens.ch.

HOYA CORPORATION

PENTAX Imaging System Division

2-36-9, Maeno-cho, Itabashi-ku, Tokyo 174-8639, JAPAN (<http://www.pentax.jp>)

PENTAX Europe GmbH Julius-Vosseler-Strasse 104, 22527 Hamburg, GERMANY

(European Headquarters) (HQ - <http://www.pentaxeuropa.com>) (Germany - <http://www.pentax.de>)

PENTAX U.K. Limited PENTAX House, Heron Drive, Langley, Slough, Berks SL3 8PN, U.K. (<http://www.pentax.uk>)

PENTAX France S.A.S. 112 Quai de Bezons, B.P. 204, 95106 Argenteuil Cedex, FRANCE (<http://www.pentax.fr>)

PENTAX Italia S.r.l. Via Dione Cassio 15, 20138 Milano, ITALY (<http://www.pentaxitalia.it>)

PENTAX (Schweiz) AG Widenholzstrasse 1, 8304 Wallisellen, Postfach 367 8305 Dietlikon, SWITZERLAND
(<http://www.pentax.ch>)

PENTAX Europe GmbH (Tyskland) Filial Sverige

Box 650, 75127 Uppsala, SWEDEN (<http://www.pentax.se>)

PENTAX Imaging Company

A Division of PENTAX of America, Inc.

(Headquarters)

600 12th Street, Suite 300 Golden, Colorado 80401, U.S.A.

(PENTAX Service Department)

12000 Zuni Street, Suite 100B Westminster, Colorado 80234, U.S.A.

(<http://www.pentaximaging.com>)

PENTAX Canada Inc. 1770 Argentia Road Mississauga, Ontario L5N 3S7, CANADA (<http://www.pentax.ca>)

**PENTAX Trading
(SHANGHAI) Limited** 23D, Jun Yao International Plaza, 789 Zhaoyiabang Road, Xu Hui District, Shanghai, 200032
CHINA (<http://www.pentax.com.cn>)

☆ Specifications and external dimensions are subject to change without notice.

☆ Printed on recycled paper.

56799

Copyright © HOYA CORPORATION 2008

H09-200804

Printed in Japan