

# PENTAX™

Digital Camera

# Optio 33*LF*

## Operating Manual

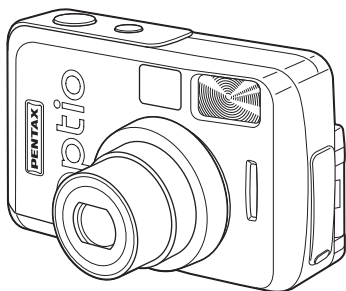

For optimum camera performance,  
please read this Operating Manual  
before using the camera.

Thank you for buying the PENTAX Optio 33LF Digital Camera. Please read this manual before using the camera in order to get the most out of all the features and functions. Keep this manual safe, as it can be a valuable tool in helping you to understand all the camera's capabilities.

### **Regarding copyrights**

Images taken using the Optio 33LF that are for anything other than personal enjoyment cannot be used without permission according to the rights as specified in the Copyright Act. Please take care, as there are even cases where limitations are placed on taking pictures even for personal enjoyment during demonstrations, industrial enterprise or as items for display. Images taken with the purpose of obtaining copyrights also cannot be used outside the scope of use of the copyright as laid out in the Copyright Act, and care should be taken here also.

### **Regarding trademarks**

- The SD logo  is a trademark.
- PENTAX is a trademark of PENTAX Corporation.
- Optio is a trademark of PENTAX Corporation.
- All other brands or product names are trademarks of registered trademarks of their respective companies.
- This product supports PRINT Image Matching II.  
When used in combination, PRINT Image Matching II enabled digital still cameras, printers and software help photographers to produce images more faithful to their intentions.  
Copyright 2001 Seiko Epson Corporation. All Rights Reserved.  
PRINT Image Matching is a trademark of Seiko Epson Corporation.

## FOR YOUR SAFETY

We have paid close attention to the safety of this product. When using this product, we request your special attention regarding items marked with the following symbols.



### **Warning**

This symbol indicates that violating this item could cause serious personal injury.



### **Caution**

This symbol indicates that violating this item could cause minor or medium personal injury, or material loss.



### **Warning**

- Do not attempt to take the camera apart or remodel the camera. High voltages are present within the camera, and there is therefore a danger of electric shocks.
- If the inside of the camera should become exposed, as a result of, for example, the camera being dropped, please do not under any circumstances touch such exposed portions, as there is a danger of receiving an electric shock.
- To avoid the risk of it being swallowed by mistake, keep the SD Memory Card/MultiMediaCard out of the reach of small children. Seek medical attention immediately if accidentally swallowed.
- Wrapping the strap of the camera around your neck is dangerous. Make sure that small children do not hang the strap around their necks.
- Use an AC adapter that is of the power and voltage specified for exclusive use with this product. The use of an AC adapter other than that specified exclusively for use with this product may cause fire or electric shocks.
- If the camera emits smoke or a strange smell, or in the event of any other irregularity, stop using the camera immediately, remove the battery or disconnect the AC adapter and contact your nearest Pentax service center. Continued use of the camera may result in fire or electric shock.
- Discontinue use of the AC adapter during thunderstorms. This can cause a fire or electric shock.

## **Caution**

- Never try to disassemble or short the battery. Also, do not dispose of the battery in fire, as it may explode.
- Do not charge any batteries other than rechargeable Ni-MH batteries. The battery could explode or catch fire. Of the batteries that can be used in this camera, only the Ni-MH battery can be recharged.
- If any of the battery leakage should come in contact with your eyes, do not rub them. Flush your eyes with clean water and get medical attention immediately.
- If any of the battery leakage should come in contact with skin or clothes, wash the affected areas thoroughly with water.
- Remove the battery from the camera immediately if it becomes hot or begins to smoke. Be careful not to burn yourself during removal.
- Some portions of the camera heat up during use, so please take care, as there is a risk of low temperature burns if such portions are held for long periods of time.
- Should the LCD be damaged, be careful of glass fragments. Also, be careful not to allow the liquid crystal to get on your skin or eyes or in your mouth.
- Do not place your finger on the flash when it is discharging as there is a risk of burns.

## **Handling the Camera**

- Take the international warranty card with you when you travel abroad. Also take the Worldwide Service Network that is included in the package. This will be useful if you experience problems with your abroad.
- When the camera has not been used for a long time, confirm that it is still working properly, particularly prior to taking important pictures (such as at a wedding or during traveling).
- Pentax is not responsible for consequential damages (costs incurred as a result of taking pictures, loss of benefits that were to be obtained through taking pictures) arising from failure of this product.
- The lens on this camera is not exchangeable. The lens is not removable.
- Do not clean the product with organic solvents such as thinner or alcohol benzene.
- Places of high temperature and humidity should be avoided. Particular care should be taken regarding vehicles, which can become very hot inside.
- Storing the camera where pesticides and chemicals are handled should be avoided.
- Remove from case and store in a well-ventilated place to prevent the camera from becoming moldy during storage.

- Do not use the camera where it may come in contact with rain, water or any other liquid, because the camera is not weather, water, or liquid resistant. Should the camera get wet from rain, splashing water, or any other liquid, wipe it off immediately with a dry soft cloth.
- Ensure that the camera is not subjected to substantial vibrations, shocks or pressure. Place the camera on a cushion for protection when the camera is subjected to the vibrations of a motorbike, car, or ship etc.
- The temperature range in which the camera can be used is 0°C to 40°C (32°F to 104°F).
- The liquid crystal display will become black at a temperature of approximately 60°C (140°F) but will return to normal when normal temperatures are returned to.
- The response speed of the liquid crystal display becomes slow at low temperatures. This is due to the properties of the liquid crystal and is not a fault.
- Periodic checks are recommended every 1 to 2 years in order to maintain high-performance.
- If the camera is subjected to rapid temperature changes, condensation may form on the inside and outside of the camera. Therefore, put the camera in a bag or plastic bag, and take the camera out when the difference in temperature has subsided.
- Avoid contact with garbage, dirt, sand, dust, water, toxic gases, salt, etc. as this may cause damage to the camera. If rain or drops of water get onto the camera, please wipe dry.
- Refer to “Precautions when using an SD Memory Card / MultiMediaCard” (p.17) regarding the SD Memory Card/MultiMediaCard.
- Please do not press forcefully on the LCD monitor. This could cause breakage or malfunction.
- When you rotate the LCD monitor, please rotate it carefully in the correct direction, and do not apply excessive force. This may cause damage to the camera.

### **To users of this camera**

- There is a possibility that recorded data may be erased or that the camera may not function correctly when used in surroundings such as installations generating strong electromagnetic radiation or magnetic fields.
- The liquid crystal panel used in the LCD display is manufactured using extremely high precision technology. Although the level of functioning pixels is 99.99% or better, you should be aware that 0.01% or fewer of the pixels may not illuminate or may illuminate when they should not. However, this has no effect on the recorded image.
- There is a possibility that the illustrations and the display screen of the LCD monitor in this manual are different from the actual product.

# Contents

FOR YOUR SAFETY .....	1
Handling the Camera .....	2
Contents .....	4
Contents of This Manual .....	7
Checking Package Contents .....	8
Names of Parts .....	9
Names of Operating Parts .....	10
<b>Getting Started</b> .....	<b>11</b>
<b>Attaching the Strap</b> .....	<b>11</b>
<b>Powering the Camera</b> .....	<b>12</b>
Installing the Batteries .....	12
Using the AC Adapter .....	14
<b>Inserting / Removing the SD Memory Card / MultiMediaCard</b> .....	<b>15</b>
<b>Swiveling the LCD Monitor (Flexible LCD Monitor)</b> .....	<b>18</b>
<b>Turning the Camera On and Off</b> .....	<b>19</b>
Playback Only Mode .....	19
<b>Initial Settings</b> .....	<b>20</b>
Setting the Display Language .....	20
Setting the Home Town .....	21
Setting the D.S.T. Mode .....	21
Setting the Video Output Format .....	22
Setting the Date and Time .....	22
<b>Quick Start</b> .....	<b>24</b>
<b>Taking Still Pictures</b> .....	<b>24</b>
<b>Playing Back Still Pictures</b> .....	<b>26</b>
Playing Back Images .....	26
Playing Back Previous or Next Images .....	27
<b>How to View the Recorded Images</b> .....	<b>28</b>
<b>Common Operations</b> .....	<b>30</b>
<b>Using Button Functions</b> .....	<b>30</b>
Capture Mode .....	30
Playback Mode .....	31
<b>Using the Menus</b> .....	<b>32</b>
How to Set the Menus .....	32
Enlarging a Menu Display .....	34
Menu List .....	35
<b>Taking Pictures</b> .....	<b>37</b>
<b>Setting the Shooting Functions</b> .....	<b>37</b>
Switching Between Modes .....	37
Displaying Shooting Information in Capture Mode .....	38
Selecting the Focus Mode .....	40

Selecting the Flash Mode .....	42
Selecting the Recorded Pixels .....	43
Selecting the Quality Level .....	44
Adjusting the White Balance .....	45
Setting the Focusing Area .....	47
Setting the Light Metering Range .....	48
Setting the Sensitivity .....	49
Setting the Instant Review Time .....	50
Setting the Image Sharpness .....	50
Setting the Color Saturation .....	51
Setting the Image Contrast .....	51
EV Compensation .....	52
<b>Taking Pictures .....</b>	<b>54</b>
Taking Pictures With Set Functions (Program Mode) .....	54
Optimizing Pictures for the Scene Type (Picture Modes) .....	55
Taking Self-Portraits .....	56
Taking Dark Scenes (Night Scene Mode) .....	57
Taking Movie Pictures (Movie Mode) .....	58
Taking Panorama Pictures (Panorama Assist Mode) .....	60
Taking Pictures with Filters (Digital Filter Mode) .....	62
Taking Pictures Continuously (Continuous Shooting) .....	63
Using the Zoom .....	64
Using the Self-Timer .....	66
<b>Saving the Settings .....</b>	<b>68</b>
Saving the Menu Items (Memory) .....	68
<b>Playback / Deleting .....</b>	<b>70</b>
<b>    Playing Back Images .....</b>	<b>70</b>
Playing Back Still Pictures .....	70
Zoom Playback .....	70
Playing Back Movie Pictures .....	72
Displaying Shooting Information in Playback mode .....	73
Nine Image Display .....	74
Slideshow .....	75
<b>    Deleting Images .....</b>	<b>76</b>
Deleting a Single Image .....	76
Deleting All Images .....	76
Protecting Images from Deletion (Protect) .....	78
<b>    Viewing Images on a TV .....</b>	<b>80</b>
<b>    Printing Service Settings (DPOF) .....</b>	<b>81</b>
Single Image Settings .....	81
Settings for All Images .....	83
Copying Images .....	84
<b>Settings .....</b>	<b>86</b>
<b>    Camera Settings .....</b>	<b>86</b>
Formatting Cards / Internal Memory .....	86

Turning the Operation Sound On and Off.....	87
Changing the Date Style and Date / Time .....	87
Setting the World Time .....	88
Changing the Display Language .....	89
Setting the Screen Effect.....	90
Setting the Background Color.....	90
Setting Auto Power Off .....	91
Setting the LCD Monitor Brightness .....	91
Selecting the Video Output Format .....	92
Changing the Start-up / Shutdown Screen .....	92
Setting Custom Functions to the Four-way Controller.....	93
Resetting to Default Settings [Reset].....	94

## **Appendix**

**95**

---

<b>List of City Names.....</b>	<b>95</b>
<b>Messages.....</b>	<b>96</b>
<b>Optional Accessories .....</b>	<b>97</b>
<b>Troubleshooting.....</b>	<b>98</b>
<b>Main Specifications .....</b>	<b>100</b>
<b>WARRANTY POLICY.....</b>	<b>102</b>



# Contents of This Manual

This operating manual contains the following chapters.

## 1 Getting Started

Explains what you need to do after purchasing the camera and before you start taking pictures. Be sure to read it and follow the instructions.

## 2 Quick Start

Explains the simplest way to take pictures and play back images. Use it if you want to get started right away. It also explains how to use the SD Memory Card / MultiMediaCard.

## 3 Common Operations

Explains common operations such as button functions and using the menus. Refer to [Taking Pictures], [Playback / Deleting], and [Settings] chapters for more details.

## 4 Taking Pictures

Explains various ways of capturing images, and how to set the relevant functions, such as setting the virtual mode dial to change capture modes, and selecting the right picture mode for the current scene.

## 5 Playback / Deleting

Explains how to play back images on the camera or a TV, and how to delete.







## 6 Settings

Explains setting camera functions.

## 7 Appendix

Explains troubleshooting, and introduces accessories sold separately.

The symbols used in this operating manual are explained below.

	Shows reference page number explaining a related operation.
	Shows information useful to know.
	Shows precautions to take when operating the camera.
 , Picture Mode , 	Icons displayed above titles represent the capture modes that can be used with that function. Ex. 
	<b>Setting Image Sharpness</b>

1

2

3

4

5

6

7

## Checking Package Contents

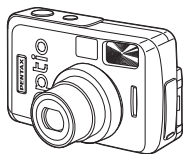

Camera  
Optio 33LF

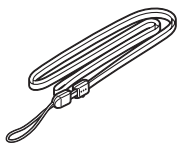

Strap  
O-ST5 (\*)

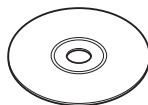

Software  
(CD-ROM) S-SW12

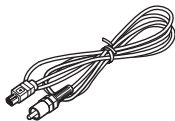

Video cable  
I-VC2 (\*)



USB cable  
I-USB2 (\*)

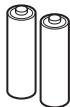

AA alkaline  
batteries (2)



Operating Manual  
(this manual)

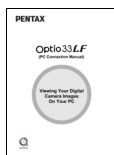

Operating Manual  
(PC Connection Manual)

\* Items marked with (\*) are also available as optional accessories.  
For other optional accessories, see "Optional Accessories" (p.97).

# Names of Parts

## Front

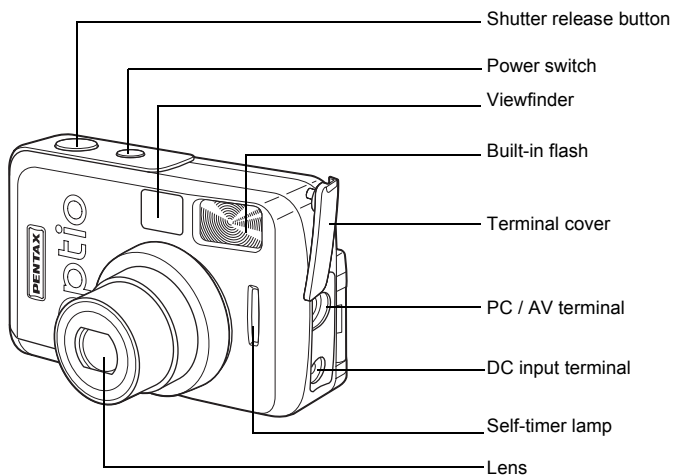

## Back

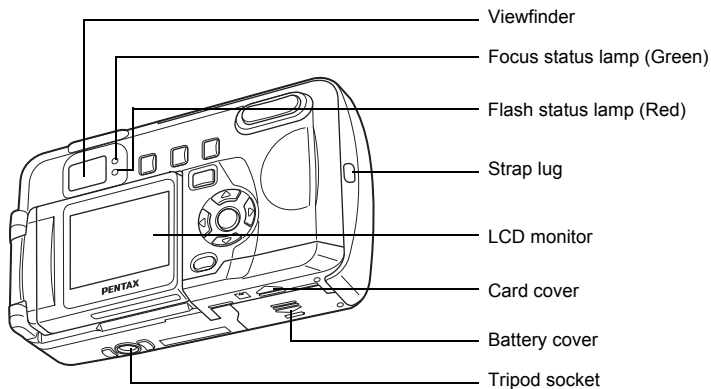

## Names of Operating Parts

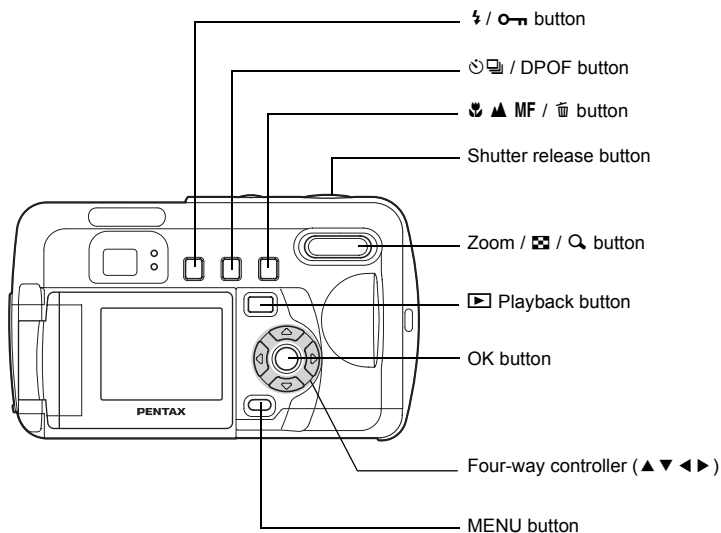

### Guide display

A button operation guide appears on the LCD monitor during operation. The buttons are indicated as shown below.

Four-way controller()	
Four-way controller()	
Four-way controller()	
Four-way controller()	
OK button	

MENU button	
Zoom /  /  button (Digital zoom and magnified playback only)	
button	
button	

## Attaching the Strap

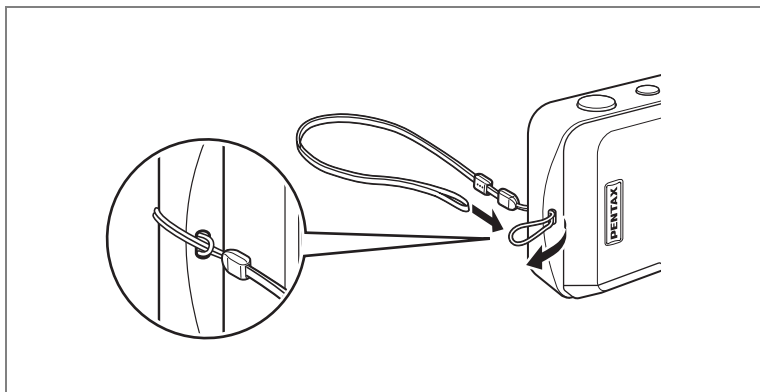

Pass the narrow end of the strap through the strap lug, and attach as shown.

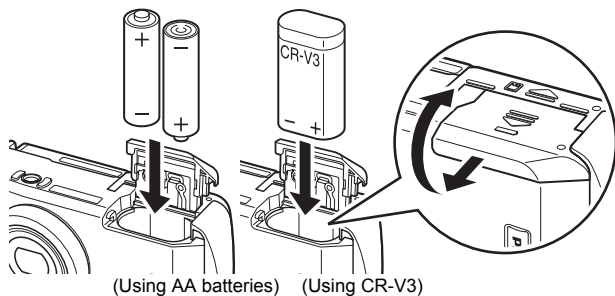

## Installing the Batteries

Install batteries in the camera. Use two AA alkaline, AA lithium or AA Ni-MH batteries or use one CR-V3 battery.

- 1 Slide the battery cover in the direction  indicated, and flip open.**
- 2 Insert the batteries according to the  $\oplus$   $\ominus$  indicator in the battery chamber.**
- 3 Close the battery cover and push horizontally to lock.**



When using for a prolonged period, use the AC adapter D-AC5 (p.14).



- AA alkaline, AA lithium and CR-V3 batteries are not rechargeable.
- Do not open the battery cover or remove the batteries when the power switch is on.
- If you do not intend to use the camera for a long time, remove the batteries. Otherwise, the batteries may leak.
- If the date and time settings have been reset when you insert new batteries after a long time, follow the procedure for “Setting the Date and Time” (p.22).
- Insert batteries correctly. Batteries inserted backwards may cause malfunction.

## Number of Captures and Playback Time (At 25°C, With New Batteries)

### ● Captures

(using flash 50% of the time)

	Image Storage Capacity
CR-V3	Approx. 500 pictures
AA lithium batteries	Approx. 350 pictures
AA Ni-MH	Approx. 250 pictures
AA alkaline batteries	Approx. 50 pictures

### ● Playback

	Playback time
CR-V3	Approx. 400 minutes
AA lithium batteries	Approx. 300 minutes
AA Ni-MH	Approx. 150 minutes
AA alkaline batteries	Approx. 60 minutes

- These figures are based on PENTAX measuring conditions. Results may vary depending on the capture mode and shooting conditions.



- Battery performance temporarily deteriorates as the temperature decreases. When using the camera in cold climates, have extra batteries on hand, keeping them warm in your pocket. Battery performance will return to normal when returned to room temperature.
- Due to the characteristics of AA alkaline batteries, camera performance may deteriorate at low temperatures. Use of other batteries (such as CR-V3) is recommended when using the camera at low temperatures.
- When traveling overseas, taking pictures in cold climates, or when you will be taking a lot of pictures, have extra batteries ready.
- You can maximize battery life by turning off the LCD monitor, and using the viewfinder to take pictures.

## Battery Level Indicator

The battery icon on the LCD monitor indicates the remaining battery level.

	(lit green)	: Adequate power remains
↓		
	(lit yellow)	: Battery is running very low
↓		
	(lit red)	: Battery is exhausted
↓		
[Battery Depleted]		: After the message is displayed, the camera will turn off.

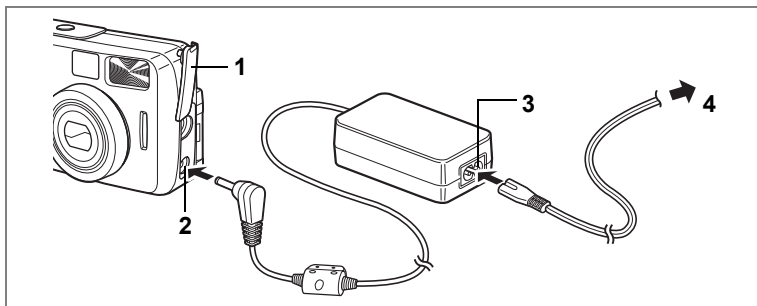

## Using the AC Adapter

When using the LCD monitor for a long time or when connecting the camera to your PC, use of the AC adapter D-AC5 (sold separately) is recommended.

- 1 Make sure the camera is turned off before opening the terminal cover.**
- 2 Connect the DC terminal on the AC adapter to the DC input terminal on the camera.**
- 3 Connect the AC plug cord to the AC adapter.**
- 4 Plug into the power outlet.**



- Make sure the camera is turned off when connecting or disconnecting the AC adapter.
- Make sure connections are secure between the camera, AC adapter, AC plug cord terminal, and the power outlet. Disconnections while the camera is recording or reading data will destroy your data.
- When using the AC adapter, be sure to read the AC adapter D-AC5 operating manual.
- You cannot charge Ni-MH batteries in the camera by connecting the AC adapter. To charge Ni-MH batteries, use an Ni-MH battery charger.



# Inserting / Removing the SD Memory Card / MultiMediaCard

1

Getting Started

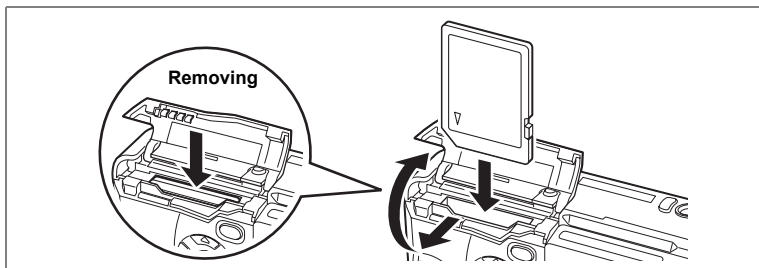

You can use an SD Memory Card and MultiMediaCard with this camera. Captured images are recorded on the SD Memory Card / MultiMediaCard if a card is inserted, or in the Built-in memory if no card is inserted. Make sure you turn off the camera before inserting or removing the SD Memory Card / MultiMediaCard.

## Inserting

- 1 Slide the card cover in the ↶ direction, and flip open.
- 2 Turn so the label side (with ▲ symbol) of the SD Memory Card / MultiMediaCard is facing toward the LCD monitor and push in until it clicks.
- 3 Close the card cover.

## Removing

- 1 Slide the card cover in the ↷ direction, and flip open.
- 2 Push the SD Memory Card / MultiMediaCard in the direction of the arrow.  
The card will pop out slightly.
- 3 Pull the card out to remove.
- 4 Close the card cover.

## ● Approximate Number of Recordable Images, Recorded Pixels, and Quality Levels

Quality Level \ Recorded Pixels	Best ★★★	Better ★★	Good ★	Movie picture (320 × 240)
2048 × 1536	6	12	18	65 seconds
1600 × 1200	11	20	28	
1024 × 768	25	47	62	
640 × 480	57	89	119	

- These figures show the number of shots when using a 16 MB SD Memory Card.
- Maximum movie picture length when using a MultiMediaCard is 30 seconds.
- These figures are based on PENTAX standard shooting conditions, and may vary depending on factors such as the subject, shooting conditions, capture mode, and SD Memory Card / MultiMediaCard used.

### Data backup recommendation

In rare cases, you may become unable to read data saved in the internal memory. It is recommended that you use a PC or other device to save important data in a location separate from the internal memory.

## Precautions when using an SD Memory Card / MultiMediaCard

- Make sure the camera is turned off before opening the card cover.
- SD Memory Cards are equipped with a write-protect switch. Setting the switch to [LOCK] protects the existing data by prohibiting recording of new data, deletion of existing data or formatting of the card.
- The PENTAX website provides a list of SD Memory Cards and MultiMediaCards that have been checked for compatibility with the camera. Inquiries on card compatibility can also be answered by your nearest PENTAX service center.
- The SD Memory Card / MultiMediaCard may be hot when removed immediately after camera use.
- Do not remove the card or turn off the power while the camera is saving to the SD Memory Card / MultiMediaCard, displaying images, or connected to a PC via a USB cable. This could cause data loss or card damage.
- Do not bend the SD Memory Cards / MultiMediaCards or subject them to violent impact. Keep away from water and store away from high temperatures.
- New cards or cards used in another camera must be formatted before use. Refer to "Formatting Cards / Internal Memory" (p.86) for information on formatting.
- Never remove the SD Memory Card / MultiMediaCard during formatting. The card may be damaged and become unusable.
- The data on an SD Memory Card / MultiMediaCard may be erased in the following circumstances. PENTAX does not accept any liability for data that is erased.
  - (1) When the user mishandles the SD Memory Card / MultiMediaCard
  - (2) When the SD Memory Card / MultiMediaCard is placed in a location with static electricity or electrical interference
  - (3) When the card is not used for a long time
  - (4) When the card, the AC adapter, or battery is removed while recording or reading data on the SD Memory Card / MultiMediaCard
- SD Memory Cards / MultiMediaCards have a limited service life. The stored data may become unreadable after long periods of disuse. Please periodically back up important data onto your PC.
- Avoid using or storing cards where static electricity or electrical interference can occur.
- Do not use or store cards where they may be exposed to sudden temperature changes, condensation, or direct sunlight.

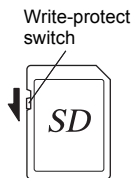

# Swiveling the LCD Monitor (Flexible LCD Monitor)

1

Getting Started

You can swivel the LCD monitor 180 degrees horizontally and up to 270 degrees vertically .

You can check the screen as you are taking the picture during self-portraits.

The screen display will also change accordingly when you swivel the monitor.

- You can swing out the monitor 180 degrees horizontally.

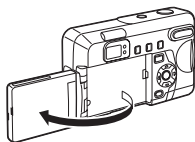

- You can swivel the monitor up to 270 degrees vertically.

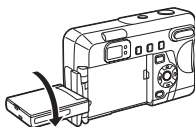
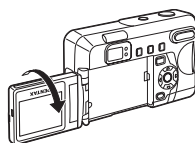

- Protect your LCD monitor when your digital camera is not in use by swiveling it to the back (PENTAX Optio logo is on the front) for storage.



Caution

Do not apply excessive force when rotating the LCD monitor.

# Turning the Camera On and Off

1

Getting Started

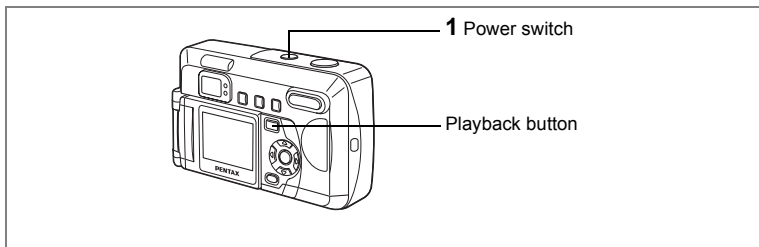

## 1 Press the power switch.

The camera will turn on. The lens cover opens and the lens extends. Press the power switch again to turn the camera off.

## Playback Only Mode

Press the power switch while pressing the Playback button activates the Playback Only mode.

- When the camera is turned on in Playback Only mode, the lens does not extend.
- To switch from Playback Only mode to Capture mode, press the power switch and then press it again.

Playing Back Still Pictures  p.26

# Initial Settings

1

Getting Started

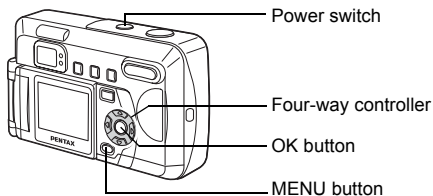

When the initial settings screen appears when you turn the camera on, follow the procedure below to set the display language, Home Town, DST, and current date and time. When the date and time that appear at the bottom right of the LCD monitor when you playback the image quickly after taking a picture is not the current time, follow the instructions for “Changing the Date Style and Date / Time” (p.87) to set the correct date and time.

## Setting the Display Language

You can choose the language in which the menus, error messages, etc. are displayed from the following: English, French, German, Spanish, Italian, Russian, Chinese and Japanese.

- 1 Turn the camera on.**
- 2 Use the four-way controller (◀▶) to select the display language.**
- 3 Press the four-way controller (▼).**

The default setting is English.

The screen for setting the city will be displayed.

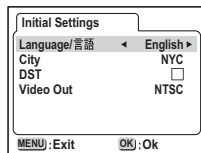

You can change the setting after it has been made. Refer to “Changing the Display Language” (p.89).

## Setting the Home Town

You can choose the city (Home Town) in which you will use the camera.

**1 Press the four-way controller (◀▶) to select the desired city (Home Town).**

**2 Press the four-way controller (▼).**

The screen for setting the DST will be displayed.

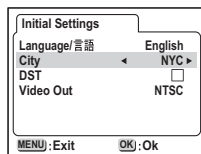

- See p.95 for the list of cities and corresponding code names.
- You can change the setting after it has been made. Refer to “Setting the World Time” (p.88).

## Setting the D.S.T. Mode

You can choose whether or not to display the D.S.T. (Daylight Saving Time) mode.

**1 Use the four-way controller (◀▶) to select [☑ (On)] or [☐ (Off)].**

The default setting is ☐ (Off).

**2 Press the four-way controller (▼).**

The screen for setting the Video Output Format will be displayed.

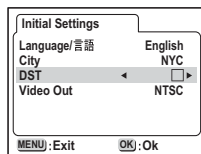

- You can change the setting after it has been made. Refer to “Setting the World Time” (p.88).

## Setting the Video Output Format

You can choose the output format (NTSC or PAL) for taking or playing back pictures using a TV monitor.

### 1 Use the four-way controller (◀▶) to select the video output format.

The default setting is NTSC.

### 2 Press the OK button.

The screen for setting the Date and Time will be displayed.

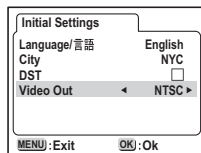

- You can change the setting after it has been made. Refer to “Selecting the Video Output Format” (p.92).

## Setting the Date and Time

Set the current date and time, and the display style.

### 1 Use the four-way controller (▲▼) to select the date and time display style.

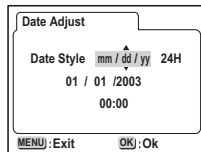

### 2 Press the four-way controller (▶). ▲▼ are displayed above and below [24H].

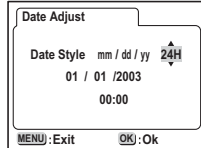

### 3 Use the four-way controller (▲▼) to select 24H (24-hour display) or 12H (12-hour display).

AM or PM is displayed in front of the hour when 12H (12-hour display) is selected.



- 4 Press the four-way controller (▶).**  
▲ ▼ are displayed above and below the month.

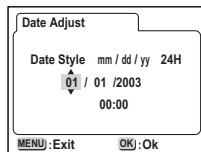

- 5 Use the four-way controller (▲▼) to change the month.**

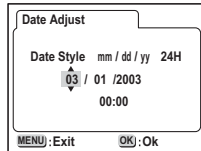

- 6 Press the four-way controller (▶).**  
▲ ▼ are displayed above and below the date.

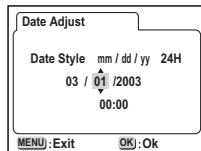

- 7 Use the four-way controller (▲▼) to set the date and press the four-way controller (▶) again.**

▲ ▼ are displayed above and below the year.

- 8 Repeat step 7 to set the year, hour, and minutes.**

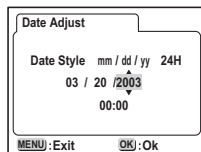

- 9 Press the OK button.**

The camera is ready to take a picture. When you set the date and time using the MENU button, you will return to the Menu screen. Press the OK button again.



- If you press the MENU button before initial settings are complete, your settings will be cancelled, but you can take pictures. If this happens, the Initial Settings screen is displayed the next time the camera is turned on.
- Your settings can be changed later from the Menu screen. To access the menu, see “Changing the Date Style and Date / Time” (p.87)

## Taking Still Pictures

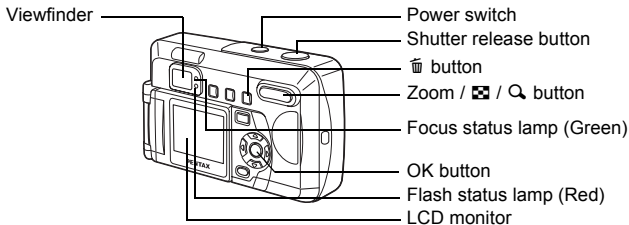

This is the simplest way to take still pictures. The flash discharges automatically depending on the light conditions.

## 1 Press the power switch.

The camera will turn on.

Screen ① is displayed for 1 second, and then the capture screen ② is displayed.

## 2 Confirm the subject and shooting information on the LCD monitor.

The focus frame in the center of the LCD screen indicates the Autofocus area. You can change the shooting area by pressing the zoom button.

⬆ Makes the subject bigger.

⬆⬆⬆ Makes the subject smaller.

You can check the size of the subject by looking through the viewfinder.

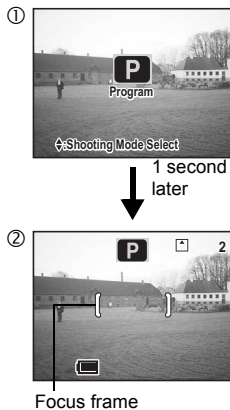

### 3 Press the shutter release button halfway.

The focus frame and the focus status lamp (green) light when the camera is in focus.

### 4 Press the shutter release button completely.

The captured image is displayed on the LCD monitor for 0.5 seconds (instant review). The captured image is saved to the SD Memory Card / MultiMediaCard, or the internal memory (the red lamp next to the viewfinder blinks while the image is being saved).

#### Pressing the Shutter Release Button

The shutter release button works in a two-step action.

##### ● Pressing halfway

Lightly press (halfway) the shutter release button to lock the focus position and exposure. The shutter speed and aperture settings appear only when pressing the shutter release button halfway. The following information is indicated by the LCD monitor, focus status lamp, and the flash status lamp.

#### 1. Autofocus area

The frame lights green when focused. It is not displayed when out of focus.

#### 2. Focus status lamp and Flash status lamp

	Focus status lamp (Green)	Flash status lamp (Red)
Lit	In focus	Flash is ready
Blink	Out of focus	Charging

You cannot take a picture while the flash is charging.

##### ● Pressing down fully

Press the shutter release button all the way down (fully) to take a picture.

#### Instant Review

The Instant Review setting is the amount of time each image is displayed immediately after being captured. The default setting is 0.5 second. Pressing the  button during image display when the Instant Review display time is more than 1 second will display the [Delete] menu. Select [Delete] and press the OK button to delete the image.

Setting the Instant Review Time  p.50

## Playing Back Still Pictures

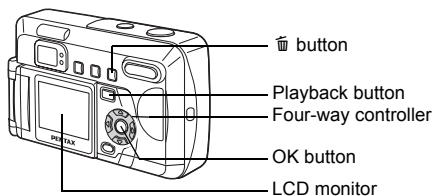

### Playing Back Images

To play back still pictures:

- 1 Press the **Playback** button  after taking a picture.

The captured image is displayed on the LCD monitor.

### Rotating a Displayed Image

Press the four-way controller ( $\blacktriangledown$ ). The image will rotate clockwise  $90^\circ$ ,  $180^\circ$  and  $270^\circ$ . Press the OK button to return to normal playback.

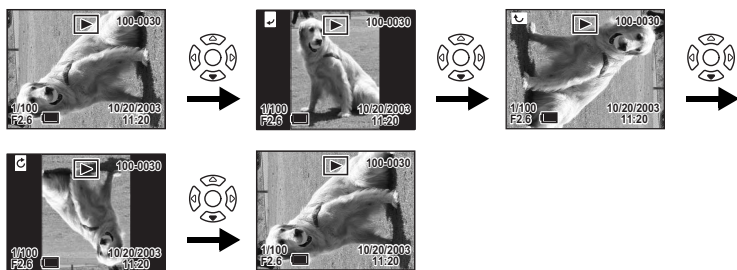

- Movie pictures cannot be rotated.
- Press the four-way controller ( $\blacktriangle$ ) to rotate the image counterclockwise.

## Playing Back Previous or Next Images

Still images can be played back one at a time, proceeding either forward or backward.

### 1 Press the Playback button after taking a picture.

The image will be displayed on the LCD monitor.

### 2 Press the four-way controller (◀▶).



Displays the previous image.





Displays the next image.

## Deleting a Displayed Image

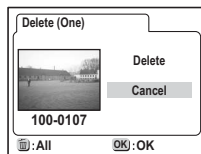
While the image is displayed, press the  button to display the Delete screen. Use the four-way controller (▲) to select [Delete], and press the OK button. The image is deleted. Press the Playback button again, or press the shutter release button halfway to return to shooting status.



- When you press the playback button, the file with the largest file number is displayed first.
- You can enlarge the image displayed on the LCD monitor by pressing the zoom /  /  button.
- Turning the camera on while pressing the Playback button activates the Playback Only mode. As the lens does not extend in Playback Only mode, this feature is useful when you want to pass the camera to someone and show them the picture you have just taken without the lens being touched. To switch to [Capture mode], turn the camera off and then turn it on again.
- For movie pictures, the first frame is displayed.
- If no images are stored, the [No Image] message will appear.

Zoom Playback  p.70

## How to View the Recorded Images

Images taken with this camera can be recorded on an SD Memory Card / MultiMediaCard or the internal memory. Images saved to an SD Memory Card / MultiMediaCard can be viewed using the camera, transferred to a computer or printed.



### Viewing Images on the Camera

One of the advantages of a digital camera is that you can check the picture as soon as you take it. You can check the composition and brightness, and take the picture again if you are not satisfied.

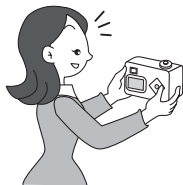

Playing Back Still Pictures  p.70

### Viewing Images on a TV

Displaying your pictures on a TV is handy for those group occasions. To view the images on your TV, connect your camera to the TV with the AV cable.

Viewing Images on a TV  p.80



## Viewing Images on a PC

You can view recorded images and edit them on a PC just by connecting the camera to the PC with the USB cable and downloading the images. Or you can remove the SD Memory Card / MultiMediaCard from the camera and transfer the data to your PC with a card reader. On a laptop, you can put a card in the card adapter and insert it into your card slot to transfer the image data. (When using other equipment to transfer your images from your SD Memory Card / MultiMediaCard, please read the operating manual for your equipment.)

Booklet: "Viewing Your Digital Camera Images On Your PC"



## Printing Images at a Printing Service

You can order conventional photograph prints by taking the SD Memory Card / MultiMediaCard with recorded images to a store that performs printing. DPOF (Digital Print Order Format) settings allow you to specify the number of copies or to include the date. Set these before taking your card to a store that performs DPOF printing.

Printing Service Settings (DPOF) p.81

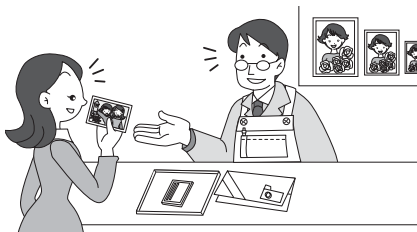

## Using Button Functions

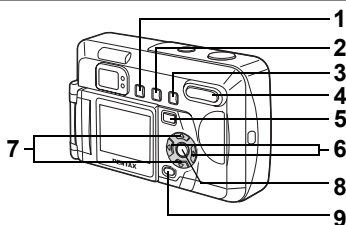

## Capture Mode

- 1 ⚡ button**  
 Changes the flash mode. (☞ p.42)
- 2 ⏸/📷 button**  
 Selects self-timer mode or continuous shooting mode. (☞ p.63, 66)
- 3 🌿/▲MF button**  
 Changes the Capture mode as follows. (☞ p.40)  
 Macro mode, infinity-landscape mode, Manual focus mode
- 4 Zoom button**  
 Changes the size of the subject. (☞ p.64)
- 5 Playback button ▶**  
 Switches to Playback mode. (☞ p.37)
- 6 Four-way controller (◀▶)**  
 Changes the EV compensation. (☞ p.52)  
 You can use the Custom Function settings to allot other functions. (☞ p.93)  
 Use MF mode to adjust focus. (☞ p.41)
- 7 Four-way controller (▲▼)**  
 Displays Virtual mode dial and changes to Capture mode. (☞ p.37)
- 8 OK button**  
 Switches display modes in the capture screen. (☞ p.38)  
 Sets menu items in the menu screen.
- 9 MENU button**  
 Displays [Rec.Mode], [Playback] and [Set-up] menus. (☞ p.32)



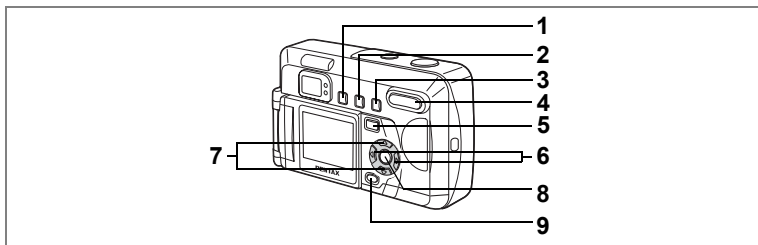

## Playback Mode

- 1 Lock button**  
 Prevents image deletion and protected images display. (☞ p.78)
- 2 DPOF button**  
 Sets DPOF settings. (☞ p.81)
- 3 Delete button**  
 Deletes the image. (☞ p.76)
- 4 Zoom / 9-image grid / Magnifying glass button**  
 Displays nine images at once when 9-image grid is pressed in Standard Playback mode. (☞ p.74)  
 Changes the image size on the LCD monitor in Zoom Display mode. (☞ p.70)
- 5 Playback button**   
 Switches to Capture mode.
- 6 Four-way controller (◀▶)**  
 Plays back previous or next image. (☞ p.27)
- 7 Four-way controller (▲▼)**  
 Rotates the displayed image clockwise / counterclockwise 90°, 180°, 270° (☞ p.26)
- 8 OK button**  
 Switches display modes in the playback screen. (☞ p.73)  
 Sets menu items in the menu screen.
- 9 MENU button**  
 Displays [Rec.Mode], [Playback] and [Set-up] menus. (☞ p.32)

# Using the Menu

When you press the MENU button, the menus are displayed on the LCD monitor. You can use these to set functions, save settings and change camera settings.

## How to Set the Menu

A button operation guide is displayed on the LCD monitor during menu operation.

### 1 Press the MENU button.

The menu screen will be displayed. The selected area will be highlighted.

### 2 Press the four-way controller (◀▶).

Use the four-way controller (◀▶) to select the menu screen.

### 3 Use the four-way controller (▲▼) to select an item.

The four-way controller (▲▼) moves the selection frame highlighted up and down.

### 4 Use the four-way controller (◀▶) to change the setting.

**Use the four-way controller (▶) to move to a selection screen if available.**

When finished, press the OK button to return to the menu.

### 5 Press the OK button.

The settings will be saved and the screen will return to Capture or Playback mode.

**Caution**

Even after you press the OK button and leave the menu screen, if you turn the camera off incorrectly (such as removing the battery when the camera is on), any changes to the setting will not be saved.

## Example of Menu Operation (Pressing the MENU Button in Capture Mode)

### 1 MENU button [CAMERA] Rec. Mode] Menu

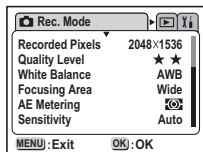

2

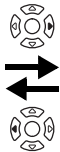

### [▶] Playback] Menu

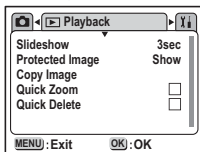

2



### [Y] Set-up] Menu

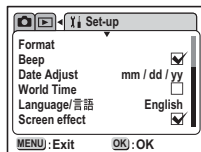

3

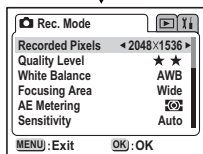

3



4

### Selection Screen



3



4

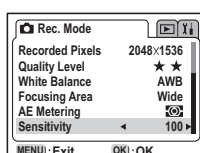
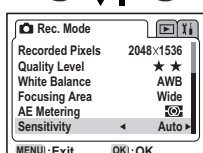



3





To the next screen

## Enlarging a Menu Display

Pressing the zoom button (  ) while a menu is displayed will enlarge the menu. Press the zoom button (  ) to return to the original display.

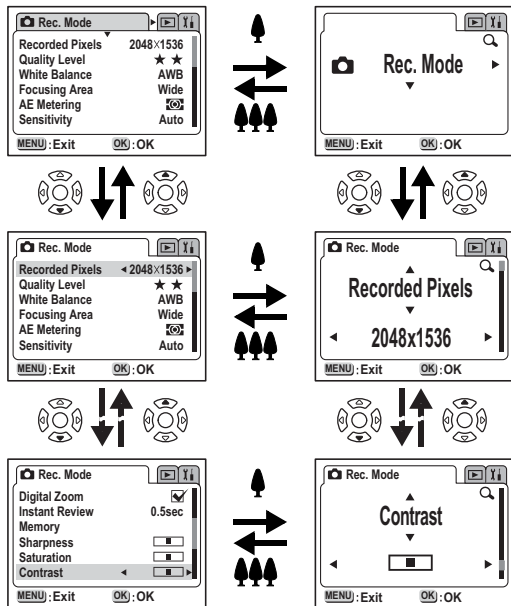
### Operation Example





- Pressing the shutter button halfway while a menu is displayed will switch the camera to Capture mode (playback screen when in Playback Only mode).
- Displaying a menu from Capture mode will display the [  Rec. Mode ] menu, and displaying a menu from Playback mode will display the [  Playback ] menu.
- When you turn off the camera while still in enlarged display mode, the next time you turn the camera on and press the MENU button, the menu will be enlarged.

## Menu List

### [📷 Rec. Mode] Menu

○ ...Setting changes are enabled (for \* functions, settings changes in Picture modes are disabled).

× ...Setting changes are disabled.

Item	Description	Default Setting	 Picture Mode		Reference
Recorded Pixels	Selects the number of recorded pixels.	2048 × 1536	○	Set to 320 × 240	p.43
Quality Level	Selects the image compression rate.	★★	○	×	p.44
White Balance	Adjusts color balance according to lighting.	AWB (Auto)	○(*)	○	p.45
Focusing Area	Changes the area for autofocus.	Wide	○	×	p.47
AE Metering	Sets the metering method to determine exposure.	 (Multi-segment)	○	×	p.48
Sensitivity	Sets sensitivity.	Auto	○	×	p.49
Digital Zoom	For taking digital zoom pictures.	<input checked="" type="checkbox"/> (on)	○	○	p.65
Instant Review	Sets the Instant Review display time.	0.5 sec (0.5 sec.)	○	×	p.50
Memory	Saves the Rec. Mode settings when the camera is turned off.		○	○ (Note)	p.68
Sharpness	Sets the sharpness.	Normal	○(*)	×	p.50
Saturation	Sets the saturation.	Normal	○(*)	×	p.51
Contrast	Sets the contrast.	Normal	○(*)	×	p.51
EV Compensation	Compensates exposure between -2.0 and +2.0.	0.0	○	○	p.52

\* Functions that cannot be changed with  (Flash, Focus mode) do not appear in mode memory.



Items marked with “×” can be changed on the menu screen, but are not reflected in actual operation.

## [▶] Playback] Menu

Item	Description	Default Setting	Reference
Slideshow	Plays recorded images successively.	3 sec (3 seconds)	p.75
Protected Image	Displays / hides files set as protected images.	Show	p.79
Copy Image	Copies files between the internal memory and the SD Memory card / MultiMediaCard.	Internal memory → memory card	p.84
Quick Zoom	When set to ON, the playback image magnification switches to 1×, 2×, 4×, 8× and 12× every time you press the zoom button (▲).	<input type="checkbox"/> (off)	p.71
Quick Delete	When this is turned on, the Delete screen is displayed with [Delete] selected.	<input type="checkbox"/> (off)	p.77

## [⏏] Set-up] Menu

Item	Description	Default Setting	Reference
Format	Formats SD Memory Card / MultiMediaCard or internal memory.	Cancel	p.86
Beep	Sets the button operation sound.	<input checked="" type="checkbox"/> (on)	p.87
Date Adjust	Sets the date and time.	mm / dd / yy	p.87
World Time	Sets the World time.	<input type="checkbox"/> (off)	p.88
Language / 言語	Changes the language for displaying menus and messages.	English	p.89
Screen effect	Ensures displays on the LCD screen will transition smoothly.	<input checked="" type="checkbox"/> (on)	p.90
Video Out	Sets the video output format.	NTSC	p.92
Background color	Sets the background color of the LCD screen.	Blue	p.90
Auto Power Off	Turns off the power automatically.	3 min. (3 minutes)	p.91
Brightness Level	Sets brightness of LCD monitor.	Normal	p.91
Screen Setting	Sets the start-up screen when the power is turned on and the shutdown screen when the power is turned off.	Blue	p.92
Custom Function	Changes four-way controller (◀▶) functions during Capture mode.	<input checked="" type="checkbox"/> (EV Compensation)	p.93
Reset	Returns settings to defaults.	Cancel	p.94

## Switching Between Modes







Capture mode is for taking pictures and playback mode is for playing back or erasing images.

### Switching between Capture Mode and Playback Mode

- Press the Playback button to switch from Capture mode to Playback mode.
- Press the Playback button or press the shutter release button halfway to switch from Playback mode to Capture mode.

### Selecting a Capture Mode

Capture modes are selected by displaying the virtual mode dial. There are 6 different Capture modes.

	Program mode	You can set all functions and take pictures.	p.54
 (Default Setting)	Picture modes	Matches your settings to the situation. There are 7 different Picture modes. (The default setting is  .)	p.55
	Night-scene mode	Takes dark scenes such as pictures taken at night.	p.57
	Movie mode	Takes movie pictures.	p.58
	Panorama assist mode	Takes panorama pictures.	p.60
	Digital Filter mode	Takes pictures using a color filter (default setting is B&W).	p.62

### 1 Press the four-way controller (▲▼) in Capture mode.

The virtual mode dial appears.

### 2 Use the four-way controller (▲▼) to select a mode.

The selected Capture mode icon will be displayed magnified.

When selecting [Picture Mode] or [Digital Filter], press the four-way controller (▶) again for more settings. See page 58 for more details

### 3 Press the OK button.

The icon for the selected Capture mode appears and the camera is ready to take pictures.

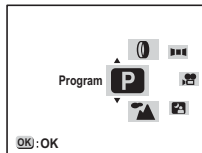

# Displaying Shooting Information in Capture Mode

The LCD monitor can be changed by pressing the OK button.

## Normal display

Shooting information is displayed when the power is turned on.

- 1 Flash
- 2 Shooting mode
- 3 Focus mode
- 4 Capture mode
- 5 AF frame
- 6 Card / internal memory
- 7 Capacity remaining
- 8 Battery indicator

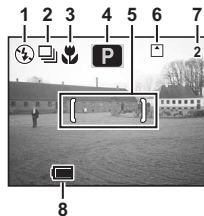

## Histogram display

The brightness distribution of the image is displayed.

The horizontal axis shows brightness (darkest at the left end and brightest at the right end), and the vertical axis shows the number of pixels.

- 1 Histogram

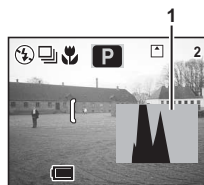

## Grid display

Grid is displayed.

Shooting information is not displayed.





## No information display

Shooting information is not displayed.

- The AF frame is displayed in autofocus, and .
- Settings are displayed for several seconds when changed.



↓  
LCD monitor Off

## LCD monitor off

Turns the LCD monitor off. (The LCD monitor is not turned off in Playback mode.)

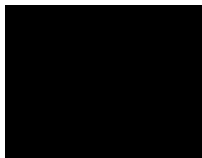





↓  
Normal display



When the LCD monitor is off, the camera will automatically switch to normal display when you switch to , MF.



The display cannot be turned off in , , and  modes.

Saving the Display settings  p.68

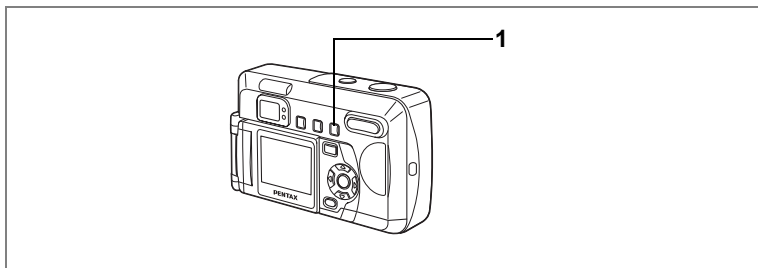

## Selecting the Focus Mode

### Focus Mode

(No icon)	Autofocus	The camera is focused on the subject in the autofocus area when the shutter release button is pressed halfway. Use this mode when the distance to the subject is more than 40 cm (1.3 ft).
🌸	Macro	Use when the distance to the subject is 10 cm to 50 cm. When the shutter release button is pressed halfway, the camera is focused on the object in the autofocus area.
▲	Infinity-landscape	Use for taking pictures of distant subjects.
MF	Manual focus	Use for adjusting focus manually by the four-way controller (▲▼).

### 1 Press the 🌸▲MF button in Capture mode.

The focus mode will change each time it is pressed and the current setting will be displayed on the LCD monitor.

The camera is ready to take the picture in the set focus mode.



- The focus mode default setting is [Autofocus].
- The focus mode is set to [Autofocus] in Movie mode (🎥 p.58).

## Manual Focus

When you press the four-way controller (◀▶) in **MF** mode, the central portion of the picture is enlarged to full-screen on the LCD monitor. Adjust the focus with the four-way controller (◀▶) while checking the image on the monitor.



For distant focus



For closer focus

After the focus is set, press any buttons except the four-way controller (◀▶), or take your finger off the four-way controller. The screen returns to the normal display two seconds later.



- When focusing, hold down the four-way controller (◀▶) to focus quickly.
- When using digital zoom, the enlarged full-screen display will align with the larger magnification rate and display.

Saving the Focus Mode  p.68

### [Conditions that make focusing difficult]

You may find it difficult to focus in on your picture when your subject is under the following kinds of conditions. When this happens, first fix the camera focus (press the shutter release button halfway) on a subject that is the same distance from the camera as the subject you want to capture. Then, with the shutter release button still held down halfway, return the camera to the position of the subject you want to capture and fully press the shutter release button.

- Against backgrounds with extremely low contrast such as blue skies or white walls
- Conditions where it is difficult to reflect light such as dark places or completely black objects
- Pictures of only horizontal lines or detailed patterns
- Objects moving at incredibly fast speeds
- Near and far objects existing in the same picture
- Brightly reflected light, strong backlight (when the surroundings are particularly bright)

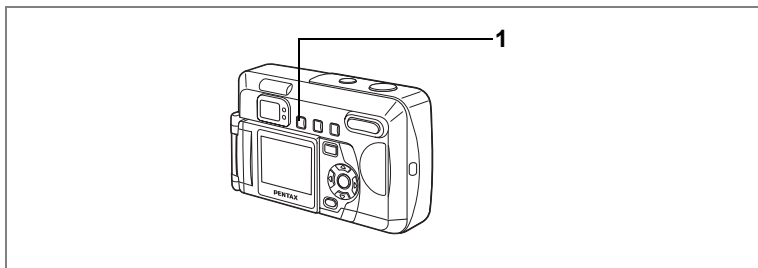

## Selecting the Flash Mode

(No icon)	Automatic flash	The flash discharges automatically depending on the light conditions.
	Flash Off	The flash will not discharge, regardless of the brightness.
	Flash On	The flash discharges, regardless of the brightness.
	Auto flash + Red-eye reduction	This mode reduces the phenomenon of red eyes caused by the light from the flash being reflected in the subject's eyes. The flash discharges automatically.
	Flash On + Red-eye reduction	This mode reduces the phenomenon of red eyes caused by the light from the flash being reflected in the subject's eyes. The flash discharges regardless of lighting conditions.



- The flash is off when the Capture mode is set to , Continuous shooting or Infinity-Landscape.
- When using the flash, it always discharges once before taking the picture, to assist with metering.
- In [Auto flash + Red-eye reduction] or [Flash On + Red-eye reduction], the flash discharges once before taking the picture to make the pupils of the subject's eyes contract, shortly before firing again to take the picture.

### 1 Press the button in Capture mode.

The flash mode changes each time the button is pressed and the icon appears on the LCD monitor.

The camera is ready to take a picture in the selected flash mode.

Focus status lamp and flash status lamp status p.25  
Saving the Flash Mode p.68

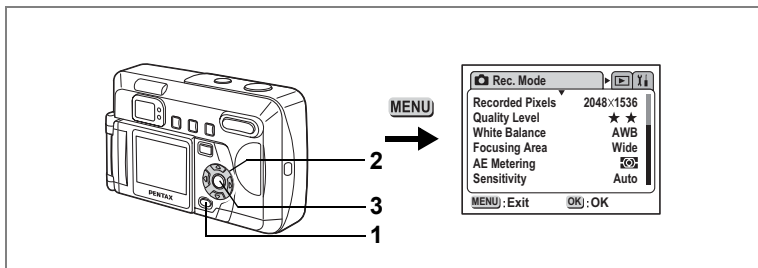

**P** Picture Mode    

## Selecting the Recorded Pixels

Select the number of recorded pixels from [2048 × 1536], [1600 × 1200], [1024 × 768] and [640 × 480].

The more pixels there are, the larger the image size and file size.

The image file size will also differ according to quality level settings.

2048 × 1536	Suitable for printing on A4 paper.
1600 × 1200	Suitable for printing on A5 paper.
1024 × 768	Suitable for printing on postcards.
640 × 480	Suitable for attaching to e-mail, or for creating websites.

- 1** Select [Recorded Pixels] on the [📷 Rec. Mode] menu.
- 2** Use the four-way controller (◀▶) to change the recorded pixels.
- 3** Press the OK button.

The camera is ready to take the picture.

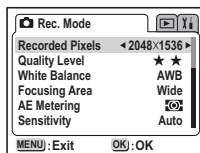

- Recorded pixels are fixed to 320 × 240 in Movie mode.
- You can print a higher quality image by increasing the recorded pixels.

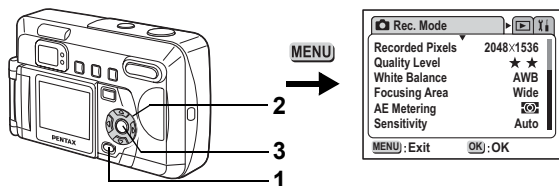

**P** Picture Mode    

## Selecting the Quality Level

4

Select the image compression rate.

The more ★ there are, the better the quality and the larger the file. The image file size will also differ according to Recorded Pixels settings.

★★★	Best	This has the lowest compression rate, and is suitable for printing large pictures on A4 paper.
★★	Better	This has a standard compression rate, and is suitable for viewing as standard photographs or on your computer screen.
★	Good	Highest compression rate. Suitable for attaching to e-mail, or for creating websites.

- 1** Select [Quality Level] on the [ Rec. Mode] menu.
- 2** Use the four-way controller (◀▶) to change the image quality.
- 3** Press the OK button.

The camera is ready to take the picture.

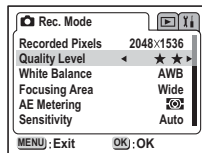

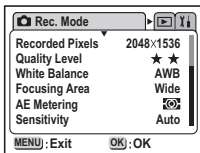
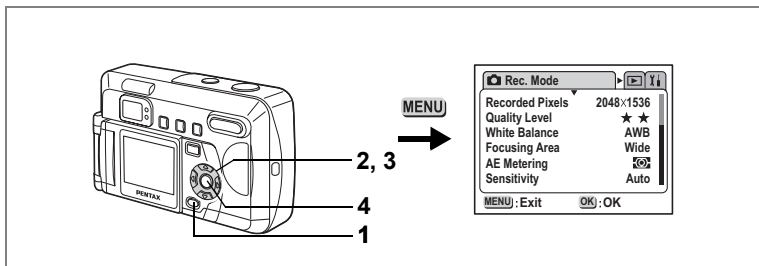

## Adjusting the White Balance

You can take pictures in natural colors by adjusting the white balance according to the light conditions at the time of shooting.

<b>AWB</b>	Auto	The camera makes the adjustment automatically.
	Daylight	For taking pictures outside in sunlight.
	Shade	For taking pictures outside in the shade.
	Tungsten Light	For taking pictures under bulb or other incandescent lights.
	Fluorescent Light	For taking pictures under fluorescent light.
	Manual	For taking pictures by manually adjusting the white balance.

**1 Select [White Balance] on the [Rec. Mode] menu.**

**2 Press the four-way controller (▶).**

The White Balance selection screen will be displayed.

**3 Use the four-way controller (▲▼) to select the setting.**



**4 Press the OK button twice.**

The camera is ready to take the picture.

Saving the White Balance p.68



You can change the setting in Picture mode but these changes are not reflected when shooting.

## Setting Manually

- 1 Select [Manual] (Manual) on the White Balance selection screen.**
- 2 Point your camera at a blank sheet of paper so that it fills the screen.**
- 3 Press the OK button.**

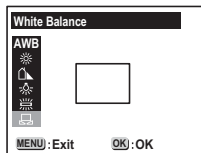

The white balance is automatically adjusted, [Complete] appears on the LCD monitor and the display returns to the menu screen.

- 4 Press the OK button.**

The camera is ready to take the picture.



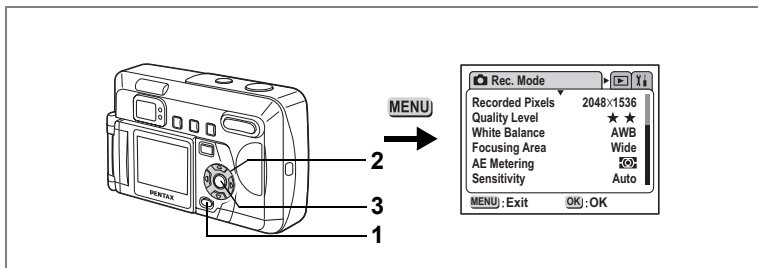

**P** Picture Mode    

## Setting the Focusing Area

You can change the autofocus area.

Wide	Normal range
Spot	The autofocus range becomes smaller.

- 1** Select [Focusing Area] on the [ Rec. Mode] menu.
- 2** Use the four-way controller (◀▶) to change the setting.
- 3** Press the OK button.

The camera is ready to take the picture.

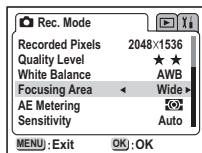

Saving the Focusing Area  p.68

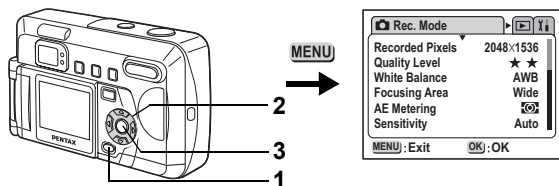



**P** Picture Mode    



## Setting the Light Metering Range

4

Taking Pictures

You can select which part of the screen to use to measure the brightness and determine the exposure.

	Multi-segment	The exposure is determined by the entire screen.
	Center-weighted	The exposure is determined mainly by the center of the screen.
	Spot	The exposure is determined by the small area in the center of the screen only.

- 1** Select [AE Metering] on the [ Rec. Mode] menu.
- 2** Use the four-way controller ( ) to change the setting.
- 3** Press the OK button.

The camera is ready to take the picture.

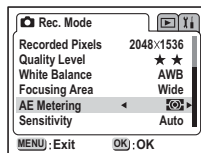

Saving the AE Metering  p.68

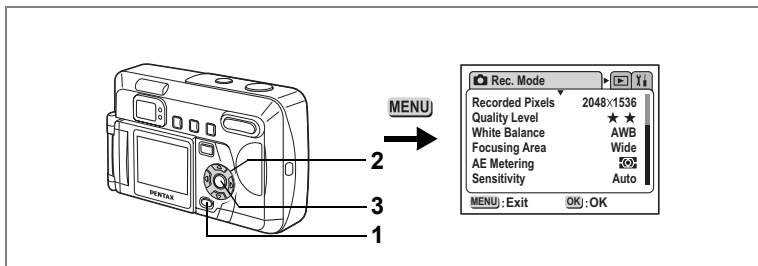

**P** Picture Mode    

## Setting the Sensitivity

You can select the Sensitivity to suit the brightness of the surroundings.

Auto	The camera makes the adjustment automatically.
100	<ul style="list-style-type: none"> <li>The lower the sensitivity (smaller number), the sharper and more noise-reduced the image. Shutter speed will be slower in low light conditions.</li> <li>The higher the sensitivity (larger number), the faster the shutter speed in low light conditions. The image will have more noise.</li> </ul>
200	
400	

- 1** Select [Sensitivity] on the [📷 Rec. Mode] menu.
- 2** Use the four-way controller (◀▶) to change the sensitivity.
- 3** Press the OK button.

The camera is ready to take the picture.

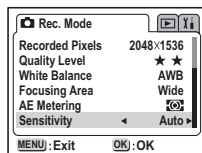

The only available AUTO settings are 100 and 200.

Saving the Sensitivity  p.68

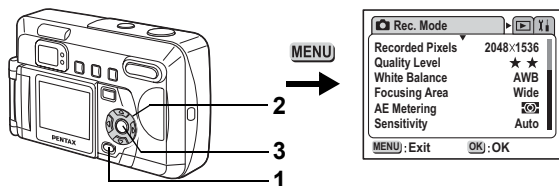

**P** Picture Mode    

## Setting the Instant Review Time

4

Taking Pictures

You can select the Instant Review display time from 0.5 sec., 1 sec., 2 sec., 3 sec., 5 sec., or OFF (no display).

- 1 Select [Instant Review] on the [**Rec. Mode**] menu.
- 2 Use the four-way controller (◀▶) to change the display time.
- 3 Press the OK button.

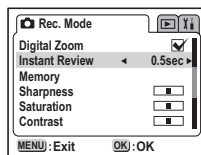

The camera is ready to take the picture.



**P**    

## Setting the Image Sharpness

You can make the image outlines sharp or soft.

- 1 Select [Sharpness] on the [**Rec. Mode**] menu.
- 2 Use the four-way controller (◀▶) to select  (Normal),  (Sharp), or  (Soft).
- 3 Press the OK button.

The camera is ready to take the picture.

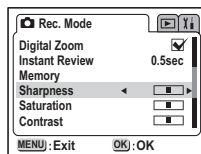

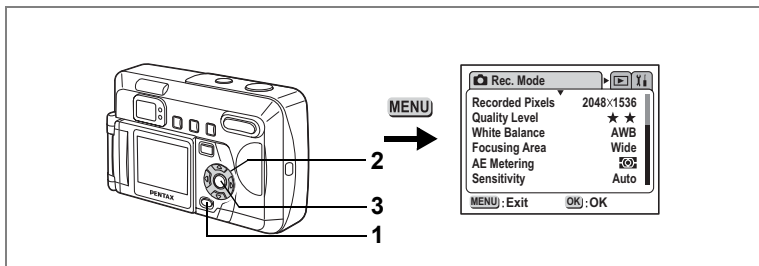

## Setting the Color Saturation

You can set the color saturation.

- 1 Select [Saturation] on the [Rec. Mode] menu.
- 2 Use the four-way controller (◀▶) to select (Normal), (High), or (Low).
- 3 Press the OK button.

The camera is ready to take the picture.

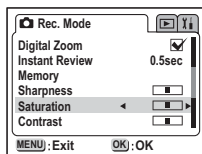

## Setting the Image Contrast

You can set the image contrast.

- 1 Select [Contrast] on the [Rec. Mode] menu.
- 2 Use the four-way controller (◀▶) to select (Normal), (High), or (Low).
- 3 Press the OK button.

The camera is ready to take the picture.

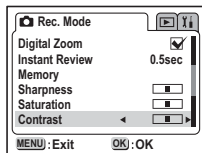

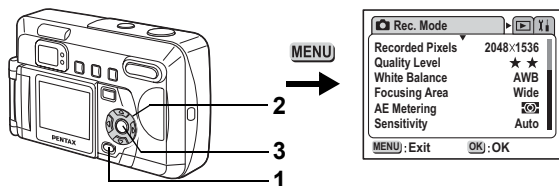

## EV Compensation

4

You can take pictures that are intentionally over-exposed or under-exposed.

**1 Select [EV Compensation] on the [Rec. Mode] menu.**

**2 Use the four-way controller (◀▶) to select the EV Compensation.**

Adjust the + side to over-expose and the – side to under-expose.

EV Compensation values can be selected in 1/3 EV steps from a range of -2.0 EV to +2.0 EV.

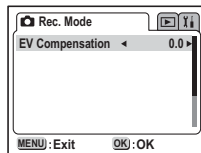

**3 Press the OK button.**

The camera is ready to take the picture.

Saving the EV Compensation p.68



The default setting for the four-way controller (◀▶) Custom Function setting is EV Compensation. ( p.93)

# Taking Pictures

When an SD Memory Card / MultiMediaCard has been inserted, all images are saved to the card.

Images are saved to the internal memory when no card has been inserted.

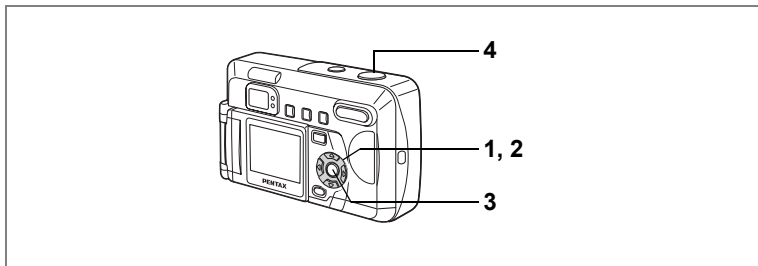

4

Taking Pictures

## Taking Pictures With Set Functions (Program Mode)

In Program mode (**P**), the camera automatically sets the shutter speed and aperture for taking still pictures. However, you can select other functions such as the flash mode or continuous shooting mode.

### 1 Press the four-way controller (**▲▼**) in Capture mode.

The virtual mode dial appears.

### 2 Use the four-way controller (**▲▼**) to select [Program (**P**)].

### 3 • Press the OK button.

The camera is ready to take the picture.

### • Set the functions you want to use.

Refer to “Setting the Shooting Functions” (p.37 to p.52) for instructions.

### 4 Press the shutter release button.

The picture will be taken.

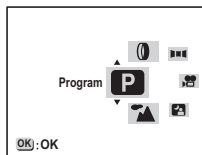

Taking Still Pictures  p.24

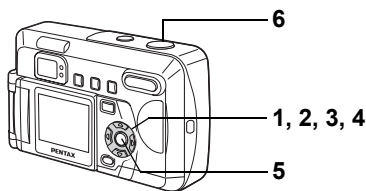

## Optimizing Pictures for the Scene Type (Picture Modes)

You can select the Picture mode according to the shooting scene.

### Picture Mode

There are seven modes available in Picture mode.

	Landscape (Default Setting)	Enhances your landscape photos.
	Flower	Enhances your flower photos.
	Portrait	Enhances your portrait photos.
	Self-Portrait	Enhances self-portraits or photos including yourself.
	Surf	Enhances photos taken against dazzling backgrounds such as beaches.
	Snow	Enhances photos taken against dazzling backgrounds such as snow.
	Sunset	Beautiful results on photos of sunsets or sunrises.

- 1 Press the four-way controller (▲▼) in Capture mode.**  
The Virtual mode dial appears.
- 2 Use the four-way controller (▲▼) to select the [Picture Mode (📷)] dial.**
- 3 Press the four-way controller (▶).**  
The Picture mode dial appears.
- 4 Use the four-way controller (▲▼) to select the icon for the desired Picture mode.**

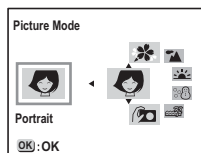
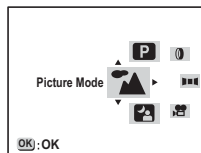



## 5 Press the OK button.

The Picture mode is selected.

## 6 Press the shutter release button.

The picture will be taken.



- In Picture mode, you also can press the shutter button halfway or press any button other than the four-way controller to set the selection.
- In Picture mode, saturation, contrast, sharpness, and white balance are automatically set to the optimum values for each mode (you can change set values but these changes are not reflected in the operation).

## Taking Self-Portraits

4

You can rotate the LCD monitor while you take a self-portrait or a two-shot, checking yourself in the LCD monitor while you take the picture.

### 1 Select [Picture Mode] on the virtual mode dial, and set it to [Self-portrait (Ⓜ)].

### 2 Rotate the LCD Monitor.

You can check yourself in the LCD monitor.

The image in the LCD monitor will also rotate when you rotate the LCD monitor.

Look into the lens before taking the picture to ensure a natural facial expression.

### 3 Press the shutter release button.

The picture will be taken.



- The captured image is recorded without being rotated.
- When pressing the shutter release button causes the camera to shake, particularly for taking pictures in low light conditions, secure the camera to a tripod or other surface and use the self-timer.

Rotating the LCD Monitor p.18

Optimizing Pictures for the Scene Type (Picture Modes) p.55

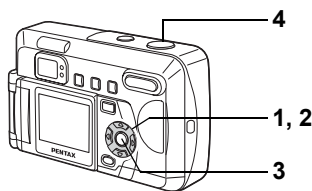

## Taking Dark Scenes (Night Scene Mode)

The settings in this mode are appropriate for taking dark scenes.

**1 Press the four-way controller (▲▼) in Capture mode.**

The virtual mode dial appears.

**2 Use the four-way controller (▲▼) to select the [Night Scene Mode (🌙)].**

**3 Press the OK button.**

The camera is ready to take the picture.

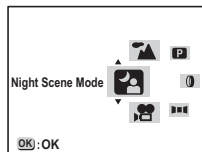

**4 Press the shutter release button.**

The picture will be taken.

Pressing the Shutter Release Button p.25  
Playing Back Still Pictures p.26



Total shooting time will be longer than the set slow shutter speed when the noise reduction function activates to reduce noise.



The shutter speed is slower when taking pictures of dark scenes. To prevent camera shaking, secure the camera on a tripod or other surface.

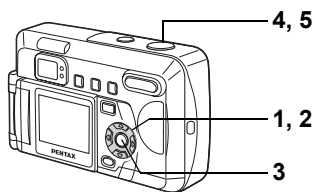

## Taking Movie Pictures (Movie Mode)

This mode enables you to take movie pictures.

When using an SD Memory Card or the internal memory, you can continue recording until the memory becomes full.

When using a MultiMediaCard, the maximum length of one recording (1 set) is approximately 30 seconds.

Sound cannot be recorded.

### 1 Press the four-way controller (▲▼) in Capture mode.

The virtual mode dial appears.

### 2 Use the four-way controller (▲▼) to select [Movie (🎥)].

### 3 Press the OK button.

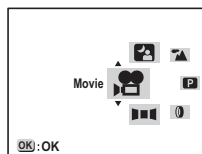

1 Flash off icon

2 Movie icon

3 Card / Internal memory

4 Capacity remaining

5 Sets remaining (when using MultiMediaCard)

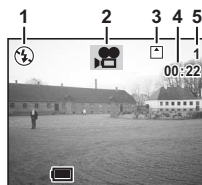

## 4 Press the shutter release button.

Recording will begin. You can change the image size using the Zoom button.

- ▲ Subject becomes bigger.
- ▲▲▲ Subject becomes smaller.

## 5 Press the shutter release button.

Recording is ended. The remaining available recording time is displayed.

### Recording by Holding Down the Shutter Release Button

When you keep the shutter release button pressed for more than one second, pictures will be taken for as long as you keep the button pressed. Shooting stops when you take your finger off the shutter release button.

Playing Back Movie Pictures  p.72



Movie pictures are saved in AVI (Motion JPEG) format. The software provided (ACDSee for PENTAX) lets you easily play back movie pictures on a PC.



- The flash will not discharge in Movie mode.
- Continuous shooting is not available in Movie mode.
- The LCD monitor cannot be turned off in Movie mode.
- The only focus mode available in Movie mode is Auto focus mode.

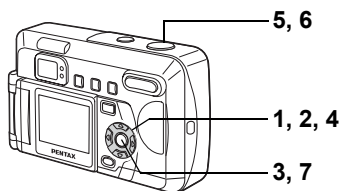

## Taking Panorama Pictures (Panorama Assist Mode)

Using the provided software (ACDSee for PENTAX), you can join multiple images and easily create panoramic photos. Use Panorama Assist mode to combine images taken so that edges overlap to create a single panoramic photo.

- 1 Press the four-way controller (▲▼) in Capture mode.**  
The virtual mode dial appears.
- 2 Use the four-way controller (▲▼) to select [Panorama Assist (■■■)].**
- 3 Press the OK button.**
- 4 Use the four-way controller to choose the joining direction.**

- ◀ Joins the images at the left.
- ▶ Joins the images at the right.
- ▲ Joins the images at the top.
- ▼ Joins the images at the bottom.

The explanation below will assume that ▶ is selected.



- 5 Take the first picture.**

Press the shutter release button to take the first image. The right edge of the image is displayed in transparent form at the left of the LCD monitor.



## 6 Move the camera to the right and take the second picture.

Position the camera so that the fixed image display overlaps the left edge of the transparent display and then release the shutter. Repeat this procedure for the third and following pictures.



## 7 Press the OK button.

The screen returns to step 4.



To cancel Panorama Assist mode, change to another mode by using the four-way controller (▲▼)



- You cannot use the camera itself to create panoramic images. Use the provided software (ACDSee for PENTAX) to join the pictures. For details on creating panorama images, see the separate booklet “Viewing Digital Camera Images on Your PC”.
- Continuous shooting is not available in Panorama Assist mode.
- The LCD monitor cannot be turned off in Panorama Assist mode.
- A computer that supports Windows is necessary for joining images to form a panorama picture. (The software provided with the camera is not supported by Macintosh.)

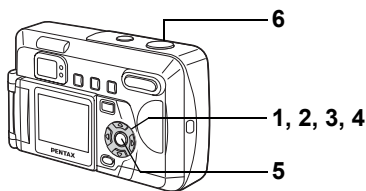

## Taking Pictures with Filters (Digital Filter Mode)

You can take pictures with digital filters in a variety of colors, such as red, blue, and green.

4

### Filters

Eight color filters are provided: black-and-white, sepia, red, green, blue, black-and-white + red, black-and-white + green, and black-and-white + blue. When you select B&W, Sepia, Red, Green, or Blue filters in Digital Filter mode, the display on the LCD monitor is filtered with the selected color, and the pictures are taken in that color.

#### 1 Press the four-way controller (▲▼) in Capture mode.

The virtual mode dial appears.

#### 2 Use the four-way controller (▲▼) to select the [Digital Filter (0)].

#### 3 Press the four-way controller (▶).

The filter selection screen is displayed.

#### 4 Use the four-way controller (▲▼) to select the filter.

#### 5 Press the OK button.

The camera is ready to take the picture.

#### 6 Press the shutter release button.

The picture will be taken.

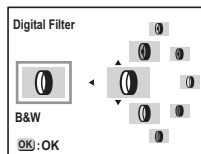
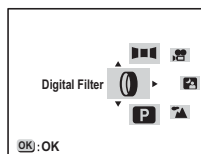

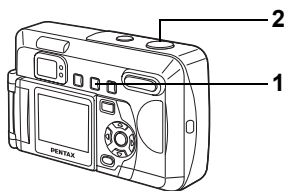

**P** Picture Mode

## Taking Pictures Continuously (Continuous Shooting)

Pictures are taken continuously while the shutter release button is pressed.

- 1 Press the button in Capture mode to display on the LCD monitor.
- 2 Press the shutter release button.

Pictures will be taken continuously while the shutter release button is pressed.

Recording stops when you release the shutter release button.

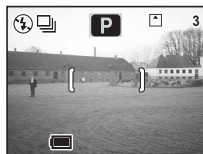

Playing Back Still Pictures p.26



- You can use the Continuous Shooting function until the SD Memory Card / MultiMediaCard becomes full.
- The interval between continuous shots will vary according to recorded pixels and quality level settings.



- The flash will not discharge in Continuous Shooting mode.
- Continuous shooting is not available for Movie or Panorama Assist mode.



You can use the Zoom to take pictures in Tele or Wide mode.

## 1 Press the Zoom button in Capture mode.

- ▲ Tele: Subject becomes bigger.
- ▲▲▲ Wide: Subject becomes smaller.

When the digital zoom function is disabled, you can take pictures at up to 3 times magnification using the optical zoom.

When the digital zoom function is enabled, you can further enlarge the subject by up to 8 times magnification.

**P** Picture Mode    

## Using the Zoom

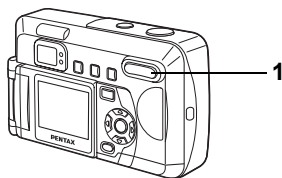

Zoom bar  
Digital Zoom range



When digital zoom is enabled

Saving the Zoom Position  p.68

Caution

- Images will become grainier when you use the digital zoom.
- The higher the zoom magnification, the more the image is affected by shaking. Stabilize the camera on a tripod or other surface to prevent shaking.

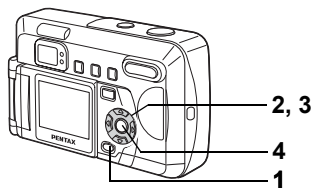

## Enabling the Digital Zoom Function

### 1 Press the MENU button in Capture mode.

The [📷 Rec. Mode] menu will appear.

### 2 Use the four-way controller (▲▼) to select [Digital Zoom].

### 3 Use the four-way controller (◀▶) to select [☑ (on)].

### 4 Press the OK button.

The camera is ready to take the picture.

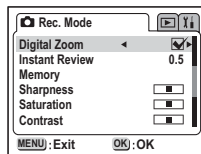

Turning off the LCD monitor turns off the digital zoom function.



When using the digital zoom, use the LCD monitor to align the picture.

Saving the Digital Zoom function setting p.68

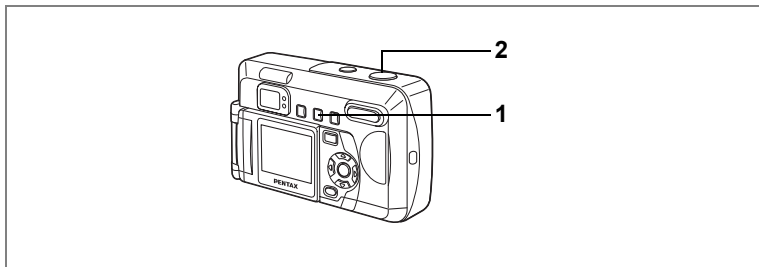

**P** Picture Mode

## Using the Self-Timer

The picture will be taken either 10 seconds or 2 seconds after the shutter release button is pressed.

**1** Press the button in Capture mode to display or on the LCD monitor.

**2** Press the shutter release button.

- The self-timer is engaged, and the self-timer lamp lights for about 7 seconds. The picture is taken about 3 seconds after the self-timer lamp starts to blink.
- The self-timer is engaged, and the picture is taken about 2 seconds after the self-timer lamp starts to blink.



- A countdown display appears on the LCD monitor.
- Pressing the four-way controller or the MENU button during count-down display will cancel the self-timer.

Playing Back Still Pictures p.26  
Taking Self-Portraits p.56

## Saving the Menu Items (Memory)

You can choose whether or not to save the set values when the camera is turned off. If you select [ (On)], the camera saves the settings in effect just before the camera is turned off. If you select [ (Off)], the settings returns to the default setting when the camera is turned off.

Item	Description	Default Setting
Flash	Saves the Flash mode setting selected with the button.	<input checked="" type="checkbox"/>
EV Compensation	Saves the EV compensation settings.	<input type="checkbox"/>
White Balance	Saves the [White Balance] settings on the [Rec. Mode] menu.	<input type="checkbox"/>
Focusing Area	Saves the [Focusing Area] settings on the [Rec. Mode] menu.	<input type="checkbox"/>
AE Metering	Saves the [AE Metering] settings on the [Rec. Mode] menu.	<input type="checkbox"/>
Sensitivity	Saves the [Sensitivity] settings on the [Rec. Mode] menu.	<input type="checkbox"/>
Digital Zoom	Saves the [Digital Zoom] settings on the [Rec. Mode] menu.	<input checked="" type="checkbox"/>
Focus Mode	Saves the Focus Mode settings.	<input type="checkbox"/>
Zoom Position	Saves the Zoom Position settings.	<input type="checkbox"/>
Display	Saves the LCD monitor display mode.	<input type="checkbox"/>
File #	Saves the file number. The next filename will have a sequential number even after changing the SD Memory Card / MultiMediaCard.	<input checked="" type="checkbox"/>



- Menu items not included in [Memory] are saved with the settings selected on the menus for each function when the camera is turned off.
- Zoom positions set within the digital zoom range will not be saved even when [Zoom Position] is set to [ (On)] in [Memory].

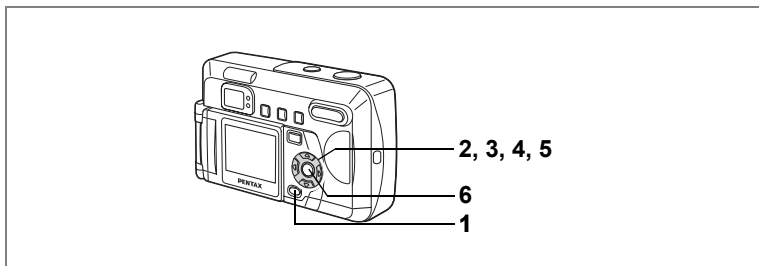

**1** Press the **MENU** button in Capture mode.

**2** Use the four-way controller (**▲▼**) to select **[Memory]**.

**3** Press the four-way controller (**▶**).  
The **[Memory]** menu appears.

**4** Use the four-way controller (**▲▼**) to select the item.

**5** Use the four-way controller (**◀▶**) to select **[✓ (on)]** or **[□ (off)]**.

**6** Press the **OK** button twice.

The camera is ready to take the picture.

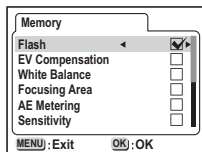
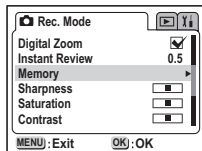

## Playing Back Images

When an SD Memory Card / MultiMediaCard has been inserted, images saved on the card are played back. Images are played back from the internal memory when no card has been inserted.

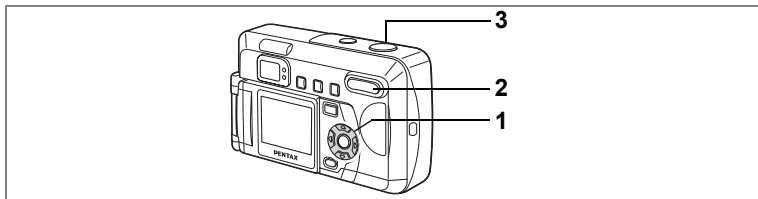

### Playing Back Still Pictures

Refer to “Playing Back Images” (p.26) and “Playing Back Previous or Next Images” (p.27).

### Zoom Playback

You can play back images magnified up to 12 times. A guide to operation appears on the LCD monitor during magnification.

- 1 In Playback mode, use the four-way controller (◀▶) to select the image to magnify.**
- 2 Press ▲ / Q on the Zoom / [ ] / Q button.**

The image is magnified (1 to 12 times). Keep pressing to continuously increase the magnification.

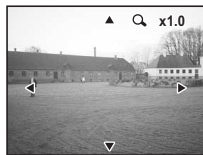

• **Operations available during Zoom display:**

- Four-way controller (▲▼◀▶) Moves zoom position
- Zoom / [ ] / Q button (▲) Makes image bigger
- Zoom / [ ] / Q button (▼) Makes image smaller

- 3 Press the shutter release button halfway.**

The camera is ready to take the picture.



Movie pictures cannot be magnified.

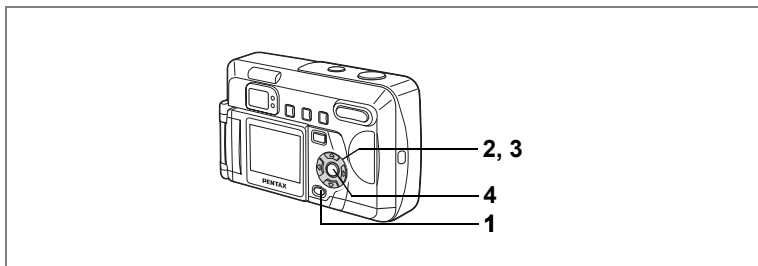

## Turning Quick Zoom On and Off

When Quick Zoom is set to on, pressing the zoom button (▲▼) during magnified display will increase display magnification to 1×, 2×, 4×, 8× and 12×.

- 1 Press the MENU button in playback mode.**

The [▶ Playback] menu appears.

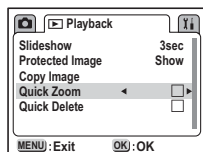

- 2 Use the four-way controller (▲▼) to select [Quick Zoom].**
- 3 Use the four-way controller (◀▶) to select [☑ (on)] or [☐ (off)].**
- 4 Press the OK button.**

The camera is ready to take the picture.

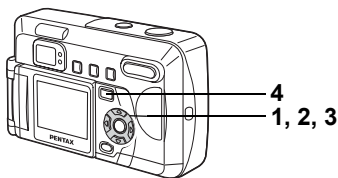

## Playing Back Movie Pictures

You can play back Movie pictures. A guide to operation appears on the LCD monitor during playback.

**1 In Playback mode, use the four-way controller (◀▶) to select the image to play back.**

**2 Press the four-way controller (▲).**

Playback will start.

- **Operations available during Playback:**

- Four-way controller (◀) Reverse playback
- Four-way controller (▶) Forward playback
- Four-way controller (▲) Pause



- **Operations available while paused:**

- Four-way controller (◀) Frame reverse
- Four-way controller (▶) Frame forward
- Four-way controller (▲) Cancels pause (Playback resumes)

**3 Press the four-way controller (▼).**

Playback will stop.

**4 Press the Playback button ◻▶.**

The camera switches to the current Capture mode.



## Displaying Shooting Information in Playback mode

You can display an overlay of playback information on the LCD monitor. Press the OK button to switch between displayed information.

### Normal display

Displays shooting information.

- 1 Playback mode
- 2 Protect icon
- 3 File number
- 4 Four-way controller operation guide
- 5 Shutter speed
- 6 Aperture
- 7 Battery indicator
- 8 Date and time

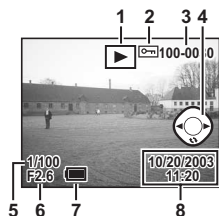

The four-way controller operation guide will only be displayed for two seconds after switching to playback mode.

### Histogram display

Displays image brightness distribution. The horizontal axis shows the brightness (darkest at the left end and brightest at the right end) and the vertical axis shows the number of pixels.

- 1 Histogram

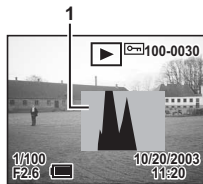

### Display Off

No shooting information is displayed.



Normal display



The LCD monitor cannot be turned off in Playback mode.

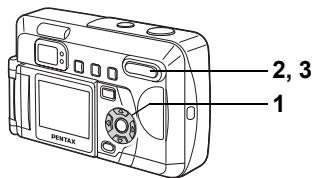

## Nine Image Display

You can display nine images at the same time.

**1** In Playback mode, use the four-way controller (◀▶) to select an image.

**2** Press / on the Zoom / / button.

Up to nine small images will be displayed at once.

Use the four-way controller (▲▼◀▶) to select an image.

A scroll bar is displayed on the right edge of the screen. When an image is selected in the bottom row, pressing the four-way controller (▼) displays the next nine images.



Selected image

Scroll bar

**3** Press / on the Zoom / / button.

The selected image is displayed by itself.

The first frame is displayed for movie pictures.



Protected images set to [Hide] (p.78, 79) are not displayed.

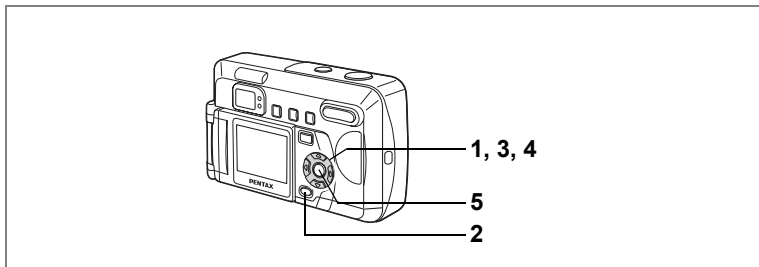

## Slideshow

You can continuously play back all images saved on an SD Memory Card / MultiMediaCard.

When no card has been inserted, all images saved in the internal memory are continuously played back.

**1 In Playback mode, use the four-way controller (◀▶) to select the first image for the slideshow.**

**2 Press the MENU button.**

The [▶ Playback] menu appears.

**3 Use the four-way controller (▲▼) to select [Slideshow].**

**4 Use the four-way controller (◀▶) to change the playback interval.**

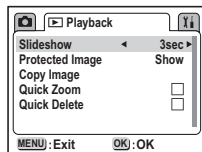

You can choose from 3 sec, 5 sec, 10 sec, 15 sec, 20 sec and 30 sec.

**5 Press the OK button.**

Playback will start at the set interval.



- Pressing any button (such as the four-way controller or the MENU button) during continuous playback will stop the slideshow.
- The slideshow will continue until you press any button.
- Movie pictures will be played through to the end and move to the next movie, regardless of the set playback interval.

# Deleting Images

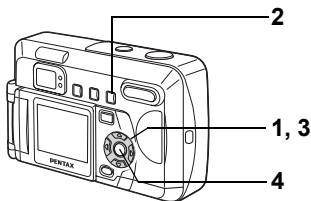

## Deleting a Single Image

- 1** In Playback mode, use the four-way controller (◀▶) to select the image to delete.
- 2** Press the button.  
The Delete screen appears.
- 3** Select [Delete] with the four-way controller (▲).
- 4** Press the OK button.

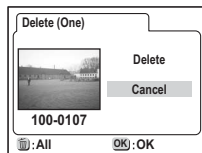

- You can also delete displayed images in Instant Review (p.25).
- Protected (🔒) images cannot be deleted unless set to [Hide].

## Deleting All Images

You can delete all saved images at once.



- Once deleted, images cannot be restored.
- Protected (🔒) images cannot be deleted unless set to [Hide].
- When an SD Memory Card / MultiMediaCard has been inserted, only images saved on the card can be deleted.

- 1** In Playback mode, press the button twice.  
The Delete All screen appears.
- 2** Use the four-way controller (▲) to select [Delete].
- 3** Press the OK button.

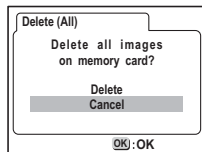

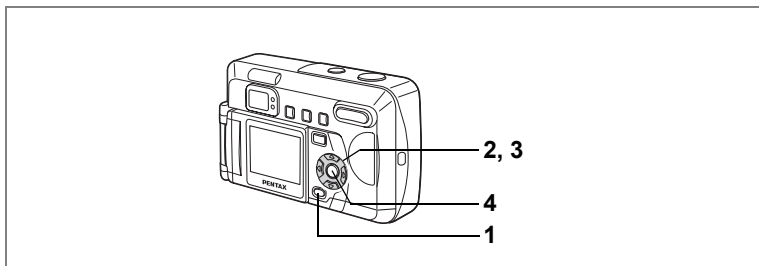

## Turning Quick Delete On and Off

When Quick Delete is set to on and the camera is in Delete (One) mode, the delete screen is displayed with [Delete] already selected.

- 1 Press the MENU button in playback mode.**

The [▶ Playback] menu appears.

- 2 Use the four-way controller (▲▼) to select [Quick Delete].**

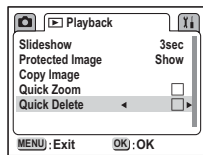

- 3 Use the four-way controller (◀▶) to select [✓ (on)] or [□ (off)].**

- 4 Press the OK button.**

The camera is ready to take the picture.

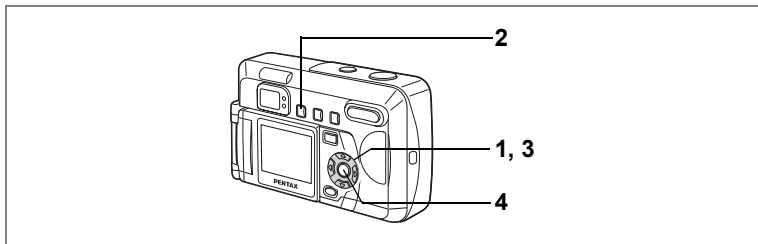

## Protecting Images from Deletion (Protect)

You can protect images from being accidentally erased. You also can prevent protected images from being displayed.

- 1 In Playback mode, select the image to protect with the four-way controller (◀▶).**
- 2 Press the  button.**  
The Protect screen appears.
- 3 Select [Protect] with the four-way controller (▲▼).**
- 4 Press the OK button.**

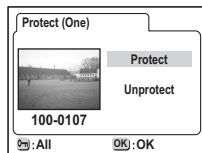

- Select [Unprotect] in step 3 to cancel the protect setting.
- The  icon appears when playing back protected images.

## Protecting All Images

- 1 Enter the Playback mode.**
- 2 Press the  button twice.**  
The Protect all screen appears.
- 3 Select [Protect] with the four-way controller (▲▼).**
- 4 Press the OK button.**



Select [Unprotect] in step 3 to cancel the protect setting on all of the images.



- Even protected images will be erased by formatting the SD Memory Card / MultiMediaCard or internal memory.
- When an SD Memory Card / MultiMediaCard has been inserted, only images saved on the card are protected.

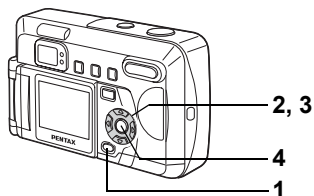

## Preventing Protected Images from Being Displayed

Set whether protected images are to be displayed.

- 1** Press the **MENU** button in playback mode.
- 2** Use the four-way controller (▲▼) to select **[Protected Image]**.
- 3** Use the four-way controller (◀▶) to switch between **[Show]** and **[Hide]**.

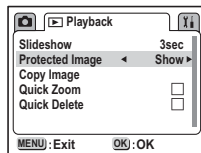

Show : Protected files are displayed.  
 Hide : Protected files are not displayed.

- 4** Press the **OK** button.



- To display the images set to [Hide], reset the camera settings by selecting [Reset] in the [Set-up] menu (p.94).
- If there are images set to [Hide], they are also deleted when you select [Delete All]. Before selecting [Delete All], always reset the camera settings to check whether there are any images set to [Hide].

# Viewing Images on a TV

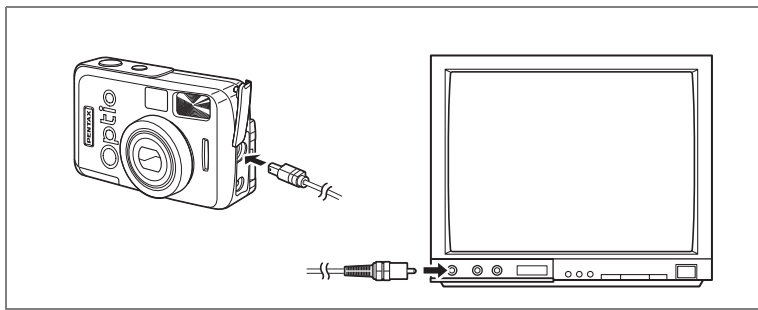

By using the video cable, you can capture and play back images on a TV or monitor with a Video IN jack. Make sure that both the TV and the camera are turned off before connecting the cable.

5

Playback / Deleting

- 1 Open the terminal cover and connect the video cable.
- 2 Connect the other end of the video cable to the Video IN jack on the TV.
- 3 Turn on the TV and the camera.

Selecting the Video Output Format  p.92



- The LCD will turn off when the camera is connected to a television.
- When the camera is connected to a television for a long time, use of the AC adapter (optional) is recommended. Refer to the operating manual for the television or equipment to which the camera is connected.



# Printing Service Settings (DPOF)

You can print the images on the SD Memory Card / MultiMediaCard using a DPOF (Digital Print Order Format) compatible printer, or at a printing service.

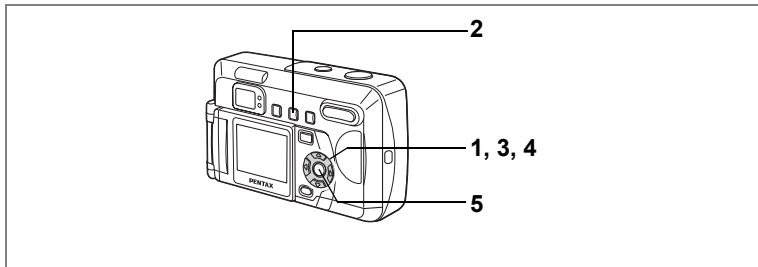

## Single Image Settings

Set the following items for each image.

- Copies: Set the number of prints up to 99.
- Date: Specify whether or not to imprint the date on the image.

**1** In Playback mode, use the four-way controller (◀▶) to select the image for DPOF settings.

**2** Press the DPOF button.

The DPOF screen appears.

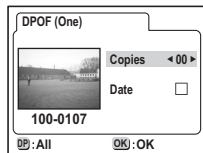

**3** Use the four-way controller (◀▶) to select the number of prints, and press the four-way controller (▼).

The frame will move to [Date].

**4** Use the four-way controller (◀▶) to select [☑] or [☐] for the date.

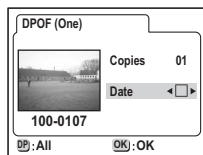

- ☑ The date will be imprinted.
- ☐ The date will not be imprinted.

## 5 Press the OK button.

Prints can be made according to the settings.



- If DPOF settings already exist for an image, the number of prints and the on / off date setting will be displayed.
- To cancel DPOF settings, set the number of prints to 00 and press the OK button.



- DPOF settings are not available for images stored in the internal memory. Make DPOF settings after copying images to the SD Memory Card / MultiMediaCard. (p.84)
- DPOF settings are not available for movie pictures.
- Some printers or printing equipment at photo processing labs may not imprint the date even when date printing is set in the DPOF settings.

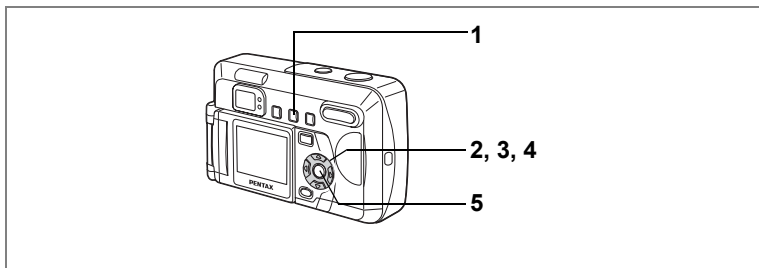

## Settings for All Images

### 1 In Playback mode, press the DPOF button twice.

The DPOF screen will be displayed.

### 2 Use the four-way controller (◀▶) to set the number of prints.

The maximum setting is 99.

### 3 Press the four-way controller (▼).

The frame will move to [Date].

### 4 Use the four-way controller (◀▶) to select or for the date.

The date will be imprinted.

The date will not be imprinted.

### 5 Press the OK button.

Prints can be made according to the setting.

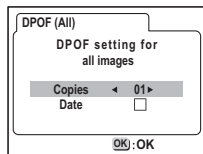

- The setting for all images will cancel settings for single images.
- The number of print copies specified in All Images is applied to all frames. Before printing, check that the number is correct.
- DPOF settings are not available for images stored in the internal memory. Make DPOF settings after copying images to the SD Memory Card / MultiMediaCard. (p.84)
- DPOF settings are not available for movie pictures.
- To cancel DPOF settings, with [All Images] selected, set the number of prints to 0.

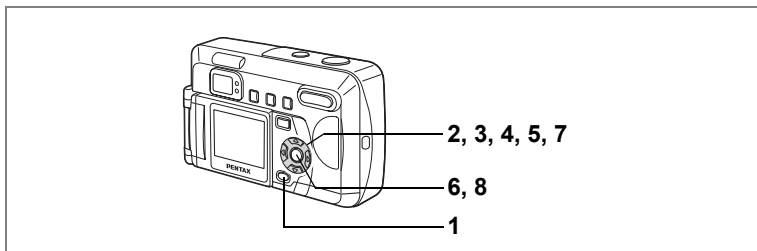

## Copying Images

Copies files between the internal memory and the SD Memory Card / MultiMediaCard. This function is not available when no card is inserted. When you copy from the internal memory to a memory card, all files are copied at once. When copying from a memory card to the internal memory, you can confirm each file you want to copy.

- 1 Press the MENU button.**
- 2 Press the four-way controller (▶).**  
The [▶ Playback] menu appears.
- 3 Use the four-way controller (▲▼) to select [Copy Image].**
- 4 Press the four-way controller (▶).**  
The Copy Image screen will be displayed.  
Select a copy method.

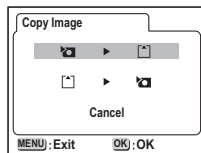
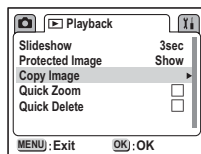

## Copying from the Internal Memory to a Memory Card

**5** Select [**▶** **▶** **▶**] with the four-way controller.

**6** Press the OK button.

All images are copied to the card.

## Copying from a Card to the Internal Memory

**5** Select [**▶** **▶** **▶**] with the four-way controller.

**6** Press the OK button.

**7** Use the four-way controller (**◀▶**) to select the image you want to copy.

**8** Press the OK button.

The selected image is copied to the internal memory.

**9** Repeat step 7 and 8 to copy images.



- Names of copied files are changed to a new file name when copying from an SD Memory Card / MultiMediaCard to the internal memory.
- Make sure you turn off the power before you insert or remove the SD Memory Card / MultiMediaCard.

How to recall the [Y/⬇️] Set-up menu

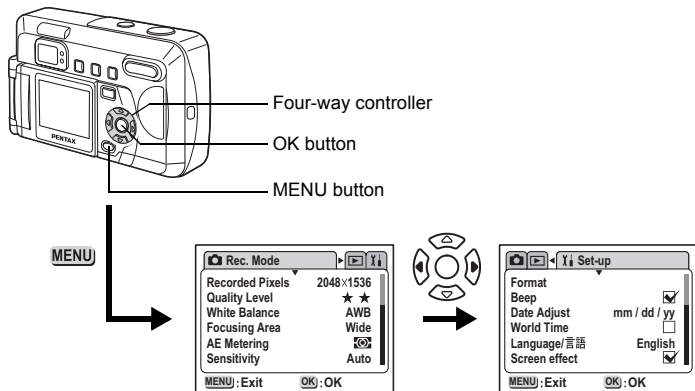

## Formatting Cards / Internal Memory

Formatting will delete all the data on the SD Memory Card / MultiMediaCard.

The internal memory is formatted when no card is inserted.



- Do not remove the card during SD Memory Card / MultiMediaCard formatting. The card may be damaged and become unusable.
- Note that formatting will also delete protected images.

**1 Select [Format] in the [Y/⬇️] Set-up menu.**

**2 Press the four-way controller (▶).**

The format screen appears.

The message on the right appears if there is a protected image set to [Hide].

**3 Select [Format] with the four-way controller (▲).**

**4 Press the OK button.**

Formatting begins. When formatting is complete, the camera is ready to take pictures.

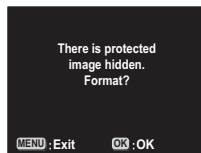

## Turning the Operation Sound On and Off

You can turn the operation sounds on and off.

- 1 Select [Beep] on the [⏏ Set-up] menu.**
- 2 Use the four-way controller (◀▶) to select [ (on)] or [ (off)].**
- 3 Press the OK button.**

The camera is ready for capture or playback.

## Changing the Date Style and Date / Time

You can change the initial date and time settings. You can also set the date display style. Choose from [yy/mm/dd], [mm/dd/yy] and [dd/mm/yy].

- 1 Select [Date Adjust] on the [⏏ Set-up] menu.**
- 2 Press the four-way controller (▶).**

The Date Adjust screen appears.

Refer to “Initial Settings” (p.20) for instructions on setting the date and time.

How to recall the [Y] Set-up] menu

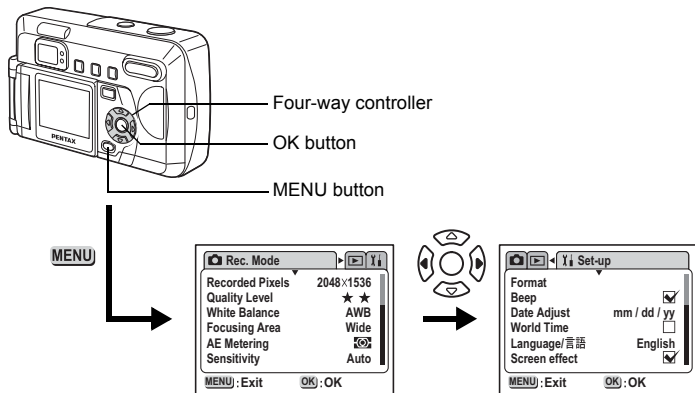

## Setting the World Time

The date and time set in “Initial Settings” (p.20) are the Home Time (your usual time zone) setting.

Setting World Time enables you to display the local date and time on the monitor when traveling overseas.

**1 Select [World Time] on the [Y] Set-up] menu.**

**2 Press the four-way controller (▶).**

The World Time setting screen appears.

**3 Use the four-way controller (◀▶) to switch between [☑] and [☐].**

Displays the time in the city selected in World Time.

Displays the time in the city selected in Home Time.

**4 Press the four-way controller (▼).**

When New York is selected as the world time city, the cross-shapes line is located in New York on the world map, and then ✈ Indicates the current time in New York (NYC).

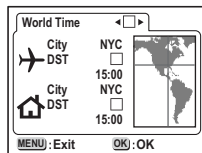



- 5 Use the four-way controller (◀▶) to select the World Time city, and press the four-way controller (▼).**
- 6 Use the four-way controller (◀▶) to select DST [ (on)] or [ (off)], and press the four-way controller (▼).**

This sets Home Time city.

When New York is selected as the Home Time city, use the four-way controller (◀▶) to select your Home Time city, or turn DST On/Off.

- 7 Press the OK button twice.**

The camera is ready to capture or play back images with the date and time of the set city.



Refer to the list on p.95 for available cities and their codes.

## Changing the Display Language

You can change the language in which the menus, error messages, and other screens are displayed.

- 1 Select [Language/言語] on the [ⓘ Set-up] menu.**
- 2 Press the four-way controller (▶).**

The Language setting screen appears.
- 3 Use the four-way controller (▲▼) to select your applicable language.**
- 4 Press the OK button.**

Menus are displayed in the language of your choice.
- 5 Press the OK button.**

The camera is ready for capture or playback.

How to recall the [Y] Set-up menu

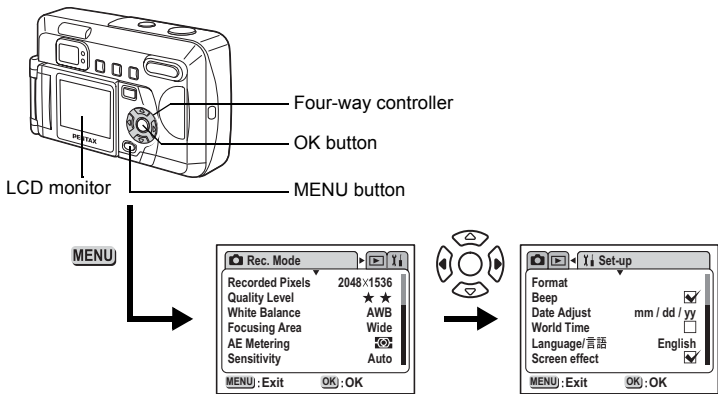

## Setting the Screen Effect

You can display various animated effects when switching display screens on the LCD monitor.

- 1 Select [Screen effect] on the [Y] Set-up menu.**
- 2 Use the four-way controller (◀▶) to select [ (on)] or [ (off)].**
- 3 Press the OK button.**

The camera is ready for capture or playback.

## Setting the Background Color

This sets the background design and color displayed on the LCD monitor.

- 1 Select [Background color] on the [Y] Set-up menu.**
  - 2 Press the four-way controller (▶).**
- The Background color screen will appear.
- 3 Use the four-way controller (▲▼◀▶) to select the background color.**
  - 4 Press the OK button twice.**

The camera is ready for capture or playback.

## Setting Auto Power Off

You can set the camera to turn off automatically after a certain period of inactivity.

- 1 Select [Auto Power Off] on the [Y/| Set-up] menu.**
- 2 Use the four-way controller (◀▶) to select [3 min.], [5 min.], or [Off].**
- 3 Press the OK button.**

The camera is ready for capture or playback.



Auto Power Off will not work during slideshow playback, while there is a USB connection, or during movie picture capture.

## Setting the LCD Monitor Brightness

You can set the brightness for your LCD monitor.

- 1 Select [Brightness Level] on the [Y/| Set-up] menu.**
- 2 Press the four-way controller (▶).**
- 3 Use the four-way controller (◀▶) to adjust the brightness.**

The LCD brightness adjustment screen appears.  
The monitor will get darker as the bar slider moves to the left and brighter as it moves to the right.

- 4 Press the OK button twice.**

The camera is ready for capture or playback.

How to recall the [Y] Set-up menu

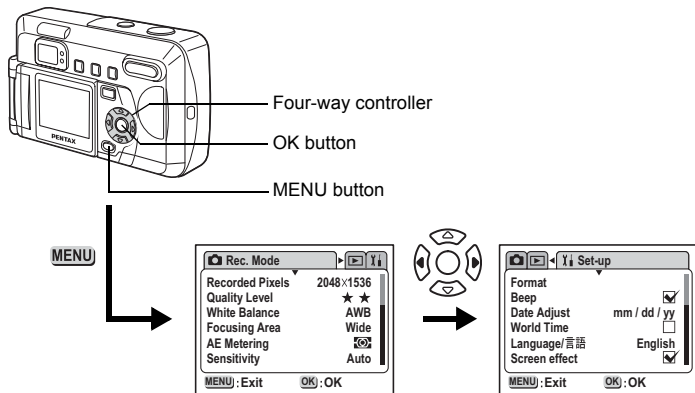

## Selecting the Video Output Format

You can select the output format (NTSC or PAL) for capturing or playing back images on a TV monitor.

- 1 Select [Video Out] on the [Y] Set-up menu.
- 2 Use the four-way controller (◀▶) to select [NTSC] or [PAL], to match your TV output format.
- 3 Press the OK button.

The camera is ready for capture or playback.

## Changing the Start-up / Shutdown Screen

You can select the start-up screen displayed when the camera power is turned on and the shutdown screen displayed when the camera power is turned off.

- 1 Select [Screen Setting] in the [Y] Set-up menu.
- 2 Press the four-way controller (▶).
- 3 Press the four-way controller (▲▼◀▶) to select the image to be used as the start-up / shutdown screen display.
- 4 Press the OK button twice.

The camera is ready for capture or playback.

## Setting Custom Functions to the Four-way Controller

You can register a frequently used function to the four-way controller (◀▶). When taking pictures, you can press the four-way controller key (◀▶) to set functions directly, without having to display the Rec. Mode menu.

### Registering a Function

- 1 Select [Custom Function] in the [⚙️ Set-up] menu.**
- 2 Use the four-way controller (◀▶) to select the function you want to register.**
- 3 Press the OK button.**

The function is registered and the camera is ready for capture or playback.



- Only one function can be registered to the four-way controller (◀▶).
- There are eleven Rec. Mode functions that can be registered:

	EV Compensation		Sensitivity
	Recorded Pixels		Sharpness
	Quality Level		Saturation
	White Balance		Contrast
	Focusing Area		Image rotation
	AE Metering		

- When you select (Image rotation), images displayed on the LCD monitor are rotated left/right each time you press the (▶) four-way controller, and rotated up/down each time you press the (◀) four-way controller.

### Retrieving functions

- 1 Press the four-way controller (◀▶) in Capture mode.**

The custom set function will be retrieved.



In MF Mode, the four-way controller (◀▶) is used to adjust the focus, thus the custom set function will not be retrieved even when the four-way controller (◀▶) is pressed.

How to recall the [Y] Set-up menu

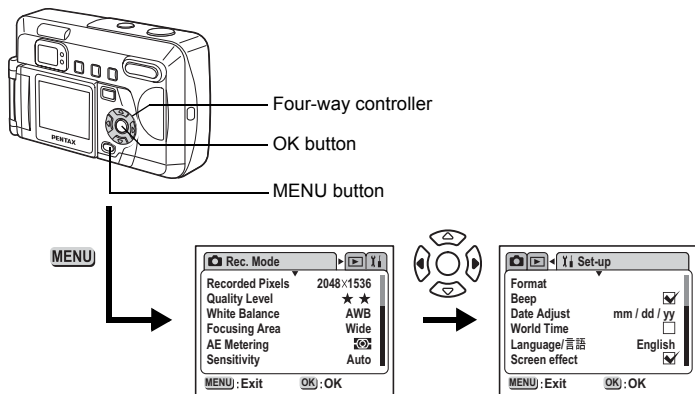

## Resetting to Default Settings [Reset]

This resets all settings other than Date / Time, Language, Video Out, and World Time.

- 1 Select [Reset] on the [Y] Set-up menu.**
- 2 Press the four-way controller (▶).**  
The Reset screen will appear.
- 3 Use the four-way controller (▲) to select [Reset].**
- 4 Press the OK button.**  
The camera is ready for capture or playback.

## List of City Names

The following are the cities and code names available for setting the World Time.

Region	City	Code	Region	City	Code
EUROPE	Madrid	MAD	ASIA	Shanghai	SHA
	London	LON		Manila	MNL
	Paris	PAR		Taipei	TPE
	Milano	MIL		Seoul	SEL
	Rome	ROM		Tokyo	TYO
	Berlin	BER	OCEANIA	Pagopago	PPG
	Moscow	MOW		Perth	PER
AFRICA	Johannesburg	JNB		Adelaide	ADL
	Cairo	CAI		Sydney	SYD
MIDDLE EAST	Istanbul	IST		Noumea	NOU
	Jerusalem	JRS		Wellington	WLG
	Jeddah	JED		Auckland	AKL
	Tehran	THR	NORTH AMERICA	Guam	GUM
	Dubai	DXB		Honolulu	HNL
	Kabul	KBL		Anchorage	ANC
ASIA	Karachi	KHI		San Francisco	SFO
	Male	MLE		Los Angeles	LAX
	Delhi	DEL		Denver	DEN
	Colombo	CMB		Chicago	CHI
	Kathmandu	KTM		Miami	MIA
	Dacca	DAC		New York	NYC
	Rangoon	RGN		Vancouver	YVR
	Bangkok	BKK		Calgary	YYC
	Kuala Lumpur	KUL		Toronto	YTO
	Vientiane	VTE		Halifax	YHZ
	Singapore	SIN	CENTRAL & SOUTH AMERICA	Mexico City	MEX
	Phnom Penh	PNH		Santiago	SCL
	Ho chi Minh	SGN		Caracas	CCS
Jakarta	JKT	Buenos Aires		BUE	
Hong Kong	HKG	Sao Paulo		SAO	
Beijing	BJS	Rio de Janeiro		RIO	

# Messages

The following messages may appear on the LCD monitor during camera operation.

Memory card full. Built-in Memory Full.	The SD Memory Card / MultiMediaCard or internal memory is full and no more images can be saved. Insert a new SD Memory Card / MultiMediaCard or delete unwanted images. (p.15, p.76) You may be able to save the image by changing the quality level or recorded pixels. (p.43, p.44)
No image	There are no images in the SD Memory Card / MultiMediaCard or internal memory. Alternately, all images are protected and are set to not display. (p.78)
Camera cannot display this image	You are trying to play back an image not supported by this camera. You may be able to display this on a PC or another brand of camera.
Battery depleted	The battery is exhausted. Charge the battery if it is a rechargeable battery, or replace with new batteries. (p.12)
Memory card error	Shooting and playback are impossible due to a problem with the SD Memory Card / MultiMediaCard. Try displaying on a PC.
Card not formatted	The SD Memory Card / MultiMediaCard you have inserted is unformatted or has been formatted on a PC or other device. (p.86)
Setting being recorded	The Image protect settings or DPOF settings are being changed.
Formatting..	Formatting SD Memory Card / MultiMediaCard or internal memory.
Deleting	The image is being deleted.
Image folder could not be created	The maximum file number has been used, and no more images can be saved. Insert a new SD Memory Card / MultiMediaCard or format the SD Memory Card / MultiMediaCard or internal memory. (p.15, p.86)
Settings not stored	The SD Memory Card / MultiMediaCard memory is full, and no more DPOF settings can be made.
Cannot save image	The image could not be saved due to a problem with the SD Memory Card / MultiMediaCard.
Card invalid	An unusable memory card has been inserted. (p.15)
Card locked	The SD Memory Card write protect switch is in the [LOCK] position. (p.17)
There is protected image hidden, Format?	The SD Memory Card / MultiMediaCard or internal memory you are trying to format contains hidden protected images.



# Optional Accessories

The following optional accessories are available for this camera.

**AC Adapter D-AC5**

**USB Cable I-USB2 (included)**







**Video cable I-VC2 (included)**

**Camera Case O-CC5**

**Strap O-ST5 (included)**

# Troubleshooting

Problem	Cause	Remedy
The camera will not turn on	No batteries are installed	Check whether batteries is installed. If not, install batteries.
	Batteries is installed incorrectly	Check orientation of batteries. Reinsert batteries according to the ⊕ ⊖ symbols in the battery compartment. (p.12)
	Batteries is exhausted	Install new batteries in the camera or use the AC Adapter.
No image on the LCD monitor	The LCD monitor is turned off	Press the OK button to turn on the LCD monitor. (p.38)
	Connected to a TV	The LCD monitor is always off when the camera is connected to a TV. (The LCD monitor is also off when the video cable I-VC2 is connected to the camera.)
	Image is displayed but hard to see	Images on the LCD monitor may be hard to see when taking pictures outside in sunlight. Change the brightness setting on your LCD monitor. (p.91)
Shutter release button will not work	Flash is charging	While the flash status lamp is blinking red, the flash is being charged and a picture cannot be taken. The lamp lights red when charging is complete.
	No available space in the SD Memory Card / MultiMediaCard or internal memory.	Insert an SD Memory Card / MultiMediaCard with available space or delete unwanted images. (p.15, p.76)
	Recording	Wait until recording is finished.

Problem	Cause	Remedy
Out of focus	Subject is difficult for Autofocus to handle	Subjects difficult for Autofocus include those with low contrast (blue skies, white walls), dark objects, fine-patterned objects, fast-moving objects, and landscapes seen through a window or net. Focus on an object the same distance away as your subject, secure the focus (by pressing shutter release button halfway), aim at your subject, and press shutter release button fully.
	Subject is not in Focusing Area	Position subject within the frame (Focusing Area) at the center of the LCD screen. If your subject is not within the focusing area, focus on your subject, secure the focus (by pressing shutter release button halfway), then re-frame your picture as desired, and press shutter release button fully.
	Subject is too close	Set the focus mode on  . (p.40)
	The focus mode is on 	When the focus mode is on  , normal pictures will be out of focus.
Picture taken with flash is dark	Subject is too far away in a dark environment (night-scenes, etc.)	Picture becomes dark if subject is too far away. Take picture within range of flash.
	Background is dark	When taking a picture of a person against a dark background, the person may appear clearly while the background appears dark, because the flash does not reach it. Set to  mode on the Virtual dial screen to ensure both person and background are clear. (p.57)
Flash does not discharge	The Flash mode is set to Off	Set to Auto or  . (p.42)
	The Capture mode is set to on  , Continuous Capture, or 	The flash will not discharge in these modes.

# Main Specifications

Type	Fully automatic compact-type digital still camera with built-in zoom lens	
Effective Pixels	3.2 megapixels	
Sensor	3.34 megapixels (total pixels), 1 / 2.7 inch interline transfer CCD with a primary color filter	
Recorded Pixels	Still picture	2048 × 1536 pixels, 1600 × 1200 pixels, 1024 × 768 pixels, 640 × 480 pixels
	Movie picture	320 × 240 pixels
Sensitivity	Auto, Manual (Equivalent to ISO100, ISO200, and ISO400)	
File Format	Still	JPEG (Exif2.2), DCF, DPOF, PRINT Image Matching II
	Movie picture	AVI (Motion JPEG), about 16fps, no sound
Quality Level	Best, Better, Good	
Storage Medium	Internal memory (approx. 12 MB), SD Memory Card / MultiMediaCard (MMC).	

## Image Storage Capacity

Recorded Pixels \ Quality Level	Best	Better	Good	Movie picture (320 × 240)
	2048 × 1536	6	12	
1600 × 1200	11	20	28	65 seconds
1024 × 768	25	47	62	
640 × 480	57	89	119	

- These figures show the number of shots when using a 16MB SD Memory Card.

White Balance	Auto, Daylight, Shade, Tungsten Light, Fluorescent light, Manual	
Lens	Focal length	5.8 mm ~ 17.4 mm (Equivalent to 38 ~ 114 mm in 35 mm format)
	Maximum aperture	f / 2.6 ~ f / 5.0
	Lens composition	6 elements in 5 groups (one lens aspherical on both sides)
	Zoom type	Electrically driven
	Capture range	38.7 mm × 28.7 mm (full screen) (Using macro mode or manual focus at max. WIDE position)
	Lens barrier	Electrically driven
Digital Zoom	Capture mode	Approx. 2.7× max. (Combines with 3× optical zoom to provide zoom equivalent to approx. 8× max.)
Viewfinder	Type	Real-image zoom viewfinder
	Magnification	Wide 0.41×, Tele 1.13×
LCD Monitor	1.6" TFD color LCD monitor (with backlight and brightness control) 72,000 pixels, Field of view approx. 100%, Swivel mechanism included 180° horizontally, up to 270° vertically	

Playback Functions	Single-frame, 9-frame index, enlargement (max. 12×), scroll, slideshow, movie playback	
Autofocus	Type	TTL contrast detection by sensor, 5-point AF (wide or spot setting can be selected).
	Capture range (From lens front)	Normal: 0.4 m ~ Infinity (full zoom range) Macro: 0.1 m ~ 0.5 m (full zoom range) Infinity-landscape: Infinity (full zoom range)
	Focus lock	By pressing the shutter release button halfway
Manual Focus	0.1m ~ Infinity	
Exposure Mechanism	AE metering	TTL metering by sensor (multi-segment, center-weighted, spot)
	Exposure modes	Program, Picture mode, Night-scene, Movie, Panorama Assist, Digital Filter
	EV compensation	±2EV (Can be set in 1 / 3 EV steps)
	Movie picture	SD Memory Card: until full MultiMediaCard: Up to 30 seconds per movie picture
Shutter	Type	Electronic / mechanical shutter
	Speed	Approx. 1 / 2000 sec. ~ 2 sec.
Flash	Type	Automatic flash with red-eye reduction function
	Flash modes	Auto, Flash Off, Flash On, Auto+Red-eye reduction, Flash On+Red-eye reduction
	Capture range	Wide    Approx. 0.2 m to 5 m (at 5.8 mm, Sensitivity AUTO) Tele     Approx. 0.1 m to 2.7 m (at 17.4 mm, Sensitivity AUTO)
Drive Modes	Single-frame, continuous, self-timer	
Self-timer	Electronically controlled, delay time: approx. 10 sec. and 2 sec.	
Time Function	World Time settings for 62 cities (28 time zones)	
Power Supply	Two AA batteries (alkaline, Ni-MH, lithium), lithium battery CR-V3, AC adapter (optional)	
Battery Life	Approx. 500 pictures	(with 50% of shooting using flash, and using lithium battery CR-V3, at 25°C) * Based on PENTAX measuring conditions.
In/Out Ports	USB / AV terminal (PC communication USB1.1), external power supply terminal	
Video Output Format	NTSC / PAL	
Size	108.5 (W) × 64.5 (H) × 41.5 (D) mm (excluding projections)	
Weight	175g (excluding battery and SD Memory Card / MultiMediaCard)	
Weight When Shooting	225g (including battery and SD Memory Card / MultiMediaCard)	
Accessories	AA alkaline batteries (2), USB cable, software (CD-ROM), video cable, strap, operating manuals (this manual, PC connection manual)	

# WARRANTY POLICY

All PENTAX cameras purchased through authorized bona fide photographic distribution channels are guaranteed against defects of material or workmanship for a period of twelve months from date of purchase. Service will be rendered, and defective parts will be replaced without cost to you within that period, provided the equipment does not show evidence of impact, sand or liquid damage, mishandling, tampering, battery or chemical corrosion, operation contrary to operating instructions, or modification by an unauthorized repair shop. The manufacturer or its authorized representatives shall not be liable for any repair or alterations except those made with its written consent and shall not be liable for damages from delay or loss of use or from other indirect or consequential damages of any kind, whether caused by defective material or workmanship or otherwise; and it is expressly agreed that the liability of the manufacturer or its representatives under all guarantees or warranties, whether expressed or implied, is strictly limited to the replacement of parts as hereinbefore provided. No refunds will be made on repairs by non-authorized PENTAX service facilities.

## Procedure During 12-month Warranty Period

Any PENTAX product which proves defective during the 12-month warranty period should be returned to the dealer from whom you purchased the equipment or to the manufacturer. If there is no representative of the manufacturer in your country, send the equipment to the manufacturer, with postage prepaid. In this case, it will take a considerable length of time before the equipment can be returned to you owing to the complicated customs procedures required. If the equipment is covered by warranty, repairs will be made and parts replaced free of charge, and the equipment will be returned to you upon completion of servicing. If the equipment is not covered by warranty, regular charges of the manufacturer or of its representatives will apply. Shipping charges are to be borne by the owner. If your PENTAX product was purchased outside of the country where you wish to have it serviced during the warranty period, regular handling and servicing fees may be charged by the manufacturer's representatives in that country. Notwithstanding this, your PENTAX product returned to the manufacturer will be serviced free of charge according to this procedure and warranty policy. In any case, however, shipping charges and customs clearance fees are to be borne by the sender. To prove the date of your purchase when required, please keep the receipt or bills covering the purchase of your equipment for at least a year. Before sending your equipment for servicing, please make sure that you are sending it to the manufacturer's authorized representatives or their approved repair shops, unless you are sending it directly to the manufacturer. Always obtain a quotation for the service charge, and only after you accept the quoted service charge, instruct the service station to proceed with the servicing.

- This warranty policy does not affect the customer's statutory rights.
- The local warranty policies available from PENTAX distributors in some countries can supersede this warranty policy. Therefore, we recommend that you review the warranty card supplied with your product at the time of purchase, or contact the PENTAX distributor in your country for more information and to receive a copy of the warranty policy.



The CE Mark is a Directive conformity mark of the European Community.

## For customers in USA

### STATEMENT OF FCC COMPLIANCE

This device complies with Part 15 of the FCC Rules. Operation is subject to the following two conditions: (1) This device may not cause harmful interference, and (2) this device must accept any interference received, including interference that may cause undesired operation. Changes or modifications not approved by the party responsible for compliance could void the user's authority to operate the equipment. This equipment has been tested and found to comply with the limits for a Class B digital device, pursuant to part 15 of the FCC Rules.

These limits are designed to provide reasonable protection against harmful interference in a residential installation. This equipment generates, uses and can radiate frequency energy and, if not installed and used in accordance with the instructions, may cause harmful interference to radio communications. However, there is no guarantee that interference will not occur in a particular installation.

If this equipment does cause harmful interference to radio or television reception, which can be determined by turning the equipment off and on, the user is encouraged to try to correct the interference by one or more of the following measures:

- Reorient or relocate the receiving antenna.  
Increase the separation between the equipment and receiver.  
Connect the equipment into an outlet on a circuit different from that to which the receiver is connected.
- \* Consult the dealer or an experienced radio / TV technician for help.

## For customers in Canada

This Class B digital apparatus meets all requirements of the Canadian Interference - Causing Equipment Regulations.

## Pour les utilisateurs au Canada

Cet appareil numérique de la classe B respecte toutes les exigences du Règlement sur le matériel brouilleur du Canada.



**Declaration of Conformity**  
According to 47CFR, Parts 2 and 15 for  
**Class B Personal Computers and Peripherals**

We: PENTAX U.S.A., Inc.

Located at: 600 12<sup>th</sup> Street, Suite 300  
Golden, Colorado 80401, U.S.A.  
Phone: 303-799-8000 FAX: 303-790-1131

Declare under sole responsibility that the product identified herein, complies with 47CFR Parts 2 and 15 of the FCC rules as a Class B digital device. Each product marketed, is identical to the representative unit tested and found to be compliant with the standards. Records maintained continue to reflect the equipment being produced can be expected to be within the variation accepted, due to quantity production and testing on the statistical basis as required by 47CFR §2.909. Operation is subject to the following two conditions: (1) This device may not cause harmful interference, and (2) This device must accept any interference received, including interference that may cause undesired operation. The above named party is responsible for ensuring that the equipment complies with the standards of 47CFR §15.101 to §15.109.

Product Name: PENTAX Digital Still Camera

Model Number: Optio 33LF

Contact person: Customer Service Manager

Date and Place: October, 2003, Colorado

<b>PENTAX Corporation</b>	2-36-9 Maeno-cho, Itabashi-ku, Tokyo 174-8639, JAPAN ( <a href="http://www.pentax.co.jp/">http://www.pentax.co.jp/</a> )
<b>PENTAX Europe GmbH (European Headquarters)</b>	Julius-Vosseler-Strasse, 104, 22527 Hamburg, GERMANY (HQ - <a href="http://www.pentaxeurope.com">http://www.pentaxeurope.com</a> ) (Germany - <a href="http://www.pentax.de">http://www.pentax.de</a> )
<b>PENTAX U.K. Limited</b>	PENTAX House, Heron Drive, Langley, Slough, Berks SL3 8PN, U.K. ( <a href="http://www.pentax.co.uk">http://www.pentax.co.uk</a> )
<b>PENTAX France S.A.S.</b>	12/14, rue Jean Poulmarch, 95106 Argenteuil Cedex, FRANCE
<b>PENTAX Benelux B.V.</b>	(for Netherlands) Spinveld 25, 4815 HR Breda, NETHERLANDS ( <a href="http://www.pentax.nl">http://www.pentax.nl</a> ) (for Belgium & Luxembourg) Weiveldlaan 3-5, 1930 Zaventem, BELGIUM ( <a href="http://www.pentax.be">http://www.pentax.be</a> )
<b>PENTAX (Schweiz) AG</b>	Widenholzstrasse 1 Postfach 367 8305 Dietlikon, SWITZERLAND ( <a href="http://www.pentax.ch">http://www.pentax.ch</a> )
<b>PENTAX Scandinavia AB</b>	P.O. Box 650, 75127 Uppsala, SWEDEN ( <a href="http://www.pentax.se">http://www.pentax.se</a> )
<b>PENTAX U.S.A., Inc</b>	600 12 <sup>th</sup> Street, Suite 300 Golden, Colorado 80401, U.S.A. ( <a href="http://www.pentax.com">http://www.pentax.com</a> )
<b>PENTAX Canada Inc.</b>	3131 Universal Drive, Mississauga, Ontario L4X 2E5, CANADA ( <a href="http://www.pentaxcanada.ca">http://www.pentaxcanada.ca</a> )



for your  
precious moments

- Printed on recycled paper
- Specifications and external dimensions are subject to change without notice.