

# PENTAX™

Digital Camera

## Optio S45

### Operating Manual

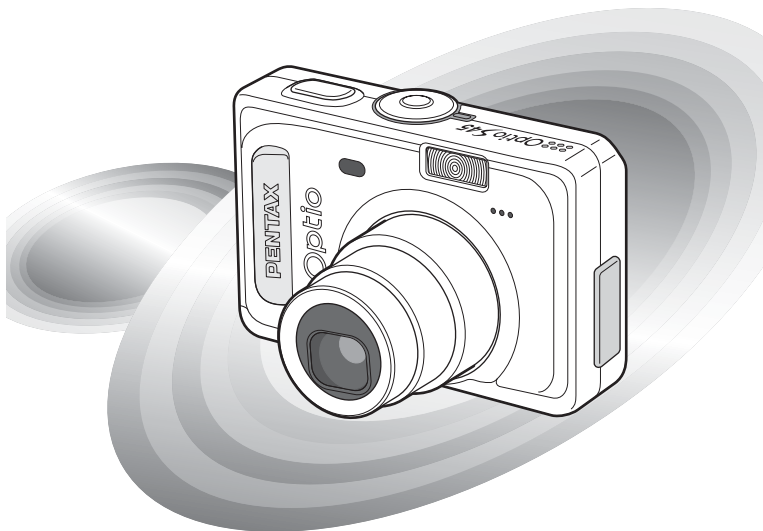

To ensure the best performance from your camera, please read the Operating Manual before using the camera.

Thank you for purchasing the PENTAX Digital Camera.

Please read this manual before using the camera in order to get the most out of all the features and functions. Keep this manual safe, as it can be a valuable tool in helping you to understand all the camera's capabilities.

### **Regarding copyrights**

Images taken using the PENTAX Digital Camera that are for anything other than personal enjoyment cannot be used without permission according to the rights as specified in the Copyright Act. Please take care, as there are even cases where limitations are placed on taking pictures even for personal enjoyment during demonstrations, performances or of items on display. Images taken with the purpose of obtaining copyrights also cannot be used outside the scope of use of the copyright as laid out in the Copyright Act, and care should be taken here also.

### **To users of this camera**

- There is a possibility that recorded data may be erased or that the camera may not function correctly when used in surroundings such as installations generating strong electromagnetic radiation or magnetic fields.
- The liquid crystal panel used in the LCD display is manufactured using extremely high precision technology. Although the level of functioning pixels is 99.99% or better, you should be aware that 0.01% or fewer of the pixels may not illuminate or may illuminate when they should not. However, this has no effect on the recorded image.

### **Regarding trademarks**

- PENTAX, Optio and smc PENTAX are trademarks of PENTAX Corporation.
- The SD logo  is a trademark.
- All other brands or product names are trademarks or registered trademarks of their respective owners.

This product supports PRINT Image Matching III. PRINT Image Matching enabled digital still cameras, printers and software help photographers to produce images more faithful to their intentions. Some functions are not available on printers that are not PRINT Image Matching III compliant. Copyright 2001 Seiko Epson Corporation. All Rights Reserved.

PRINT Image Matching is a trademark of Seiko Epson Corporation.

The PRINT Image Matching logo is a trademark of Seiko Epson Corporation.

### **Regarding PictBridge**

- PictBridge allows the user to connect the printer and digital camera directly, using the unified standard for the direct printout of images. You can print images directly from the camera through a few simple operations.
- There is a possibility that the illustrations and the display screen of the LCD monitor in this manual are different from the actual product.

## FOR SAFE USE OF YOUR CAMERA

Sufficient attention has been paid to the safety of this product but please pay particular attention to the warnings indicated by the following symbols during use.



### **Warning**

These symbols indicate that it is possible that the user may experience serious difficulties if the warnings are not heeded.



### **Caution**

These symbols indicate that it is possible that the user may experience minor or middling difficulties or physical difficulties if the warnings are not heeded.

## About the Camera



### **Warning**

- Do not attempt to take the camera apart or remodel the camera. High voltages are present within the camera, and there is therefore a danger of electric shocks if the camera is taken apart.
- If the inside of the camera should become exposed as a result of, for example, the camera being dropped, please do not under any circumstances touch such exposed portions, as there is a danger of receiving an electric shock.
- Wrapping the strap of the camera around your neck is also dangerous. Please take care that small children do not hang the strap around their necks.
- To avoid the risk of it being swallowed by mistake, keep the SD Memory Card out of the reach of small children. Seek medical attention immediately if a memory card is accidentally swallowed.
- Use an AC adapter that is of the power and voltage specified for exclusive use with this product. The use of an AC adapter other than that specified exclusively for use with this product may cause fire or electric shocks.
- If the camera emits smoke or a strange smell, or in the event of any other irregularity, stop using the camera immediately, remove the battery or disconnect the AC adapter and contact your nearest PENTAX service center. Continued use of the camera may result in fire or electric shock.

## **Caution**

- Never try to disassemble or short the battery. Also, do not dispose of the battery in fire, as it may explode.
- Do not charge any batteries other than rechargeable Ni-MH batteries. The battery could explode or catch fire. The batteries that can be used in this camera, only the Ni-MH battery can be recharged.
- Do not place your finger on the flash when it is discharging as there is a risk of burns.
- Do not discharge the flash while it is touching your clothing as there is a risk of discoloring.
- If any of the battery leakage should come in contact with your eyes, do not rub them. Flush your eyes with clean water and get medical attention immediately.
- If any of the battery leakage should come in contact with skin or clothes, wash the affected areas thoroughly with water.
- Remove the battery from the camera immediately if it becomes hot or begins to smoke. Be careful not to burn yourself during removal.
- Some portions of the camera heat up during use, so please take care, as there is a risk of low temperature burns if such portions are held for long periods of time.
- Should the LCD be damaged, be careful of glass fragments. Also, be careful not to allow the liquid crystal to get on your skin or in your eyes or in your mouth.

## **Handling precautions for batteries**

- This camera uses two AA alkaline, AA lithium, AA Ni-MH, AA nickel manganese batteries or one CR-V3 battery. Do not use batteries other than those specified here. Using some other type of battery may cause the camera to function poorly, or the batteries may rupture or cause a fire.
- AA alkaline, AA lithium, AA nickel manganese and CR-V3 batteries cannot be recharged. Do not try to take the batteries apart. The batteries may rupture or leak if you try to charge them or take them apart.
- Do not replace the batteries with batteries that are different brands, types or capacities. Also, do not combine old batteries with new ones. Doing so may cause the batteries to rupture or cause a fire.
- Do not insert the batteries with the positive (+) and negative (-) poles in the wrong orientation. Doing so may cause the batteries to rupture or cause a fire.

## About the AC Adapter



### Caution

- Do not place heavy objects on the AC plug cord, allow heavy objects to drop onto it or allow the AC plug cord to become damaged due to excessive bending. If the AC plug cord becomes damaged, consult a PENTAX Service Center.
- Do not short or touch the output terminals of the product while it is still plugged in.
- Do not plug in the AC plug cord with wet hands. This can cause an electrical shock.
- Do not subject the product to strong impacts or allow it to drop onto a hard surface. This can cause a malfunction.

## Care to be Taken During Handling

- Take the international warranty card with you when you travel abroad. Also take the Worldwide Service Network that is included in the package. This will be useful if you experience problems abroad.
- When the camera has not been used for a long time, confirm that it is still working properly, particularly prior to taking important pictures (such as at a wedding or during traveling). Contents of the recording cannot be guaranteed if recording, playback or transferring your data to a computer, etc. is not possible due to a malfunction of your camera or recording media (SD Memory Card), etc.
- The lens on this camera is not exchangeable. The lens is not removable.
- Do not clean the product with organic solvents such as thinner, alcohol or benzene.
- Places of high temperature and humidity should be avoided. Particular care should be taken regarding vehicles, which can become very hot inside.
- Storing the camera where pesticides and chemicals are handled should be avoided. Remove from case and store in a well-ventilated place to prevent the camera from becoming moldy during storage.
- Do not use the camera where it may come in contact with rain, water or any other liquid, because the camera is not weather, water, or liquid resistant.
- Ensure that the camera is not subjected to substantial vibrations, shocks or pressure. Place the camera on a cushion for protection when the camera is subjected to the vibrations of a motorbike, car, or ship, etc.
- **The temperature range in which the camera can be used is 0°C to 40°C (32°F to 104°F).**
- The liquid crystal display will become black at high temperatures but will return to normal when normal temperatures are returned to.
- The response speed of the liquid crystal display becomes slow at low temperatures. This is due to the properties of the liquid crystal and is not a fault.
- Periodic checks are recommended every 1 to 2 years in order to maintain high performance.

- If the camera is subjected to rapid temperature changes, condensation may form on the inside and outside of the camera.  
Therefore put the camera in a bag or plastic bag, and take the camera out when the difference in temperature has subsided.
- Avoid contact with garbage, dirt, sand, dust, water, toxic gases, salt, etc. as this may cause damage to the camera. If rain or drops of water get onto the camera, please wipe dry.
- Refer to “Precautions When Using an SD Memory Card” (p.22) regarding the SD Memory Card.
- Please do not press forcefully on the LCD monitor. This could cause breakage or malfunction.
- Be careful not to sit down with the camera in your back pocket as this may damage the exterior of the camera or the LCD monitor.
- When using a tripod with the camera, be careful not to overtighten the screw in the tripod socket on the camera.

# Contents

FOR SAFE USE OF YOUR CAMERA .....	1
Care to be Taken During Handling .....	4
Contents .....	6
Contents of the Operating Manual .....	11
Checking the Contents of the Package .....	12
Names of Parts .....	13
Names of Operating Parts .....	14
<b>Getting Started</b> .....	<b>15</b>
<b>Attaching the Strap</b> .....	<b>15</b>
<b>Powering the Camera</b> .....	<b>16</b>
Installing the Batteries .....	16
Using the AC Adapter (optional) .....	18
Using the AC Adapter Overseas .....	19
<b>Installing the SD Memory Card</b> .....	<b>21</b>
Recorded Pixels and Quality .....	23
<b>Turning the Camera On and Off</b> .....	<b>25</b>
Playback Only Mode .....	26
Voice Recording Only Mode .....	26
<b>Initial Setting</b> .....	<b>27</b>
Setting the Display Language .....	27
Setting the Date and Time .....	28
<b>Quick Start</b> .....	<b>30</b>
<b>Taking Still Pictures</b> .....	<b>30</b>
<b>Playing Back Still Pictures</b> .....	<b>32</b>
Playing Back Images .....	32
Playing Back the Previous or Next Image .....	32
Rotating the Displayed Image .....	33
<b>Common Operations</b> .....	<b>34</b>
<b>Using the Button Functions</b> .....	<b>34</b>
Capture Mode .....	34
Playback Mode .....	35
Voice Recording Mode .....	36
<b>Using the Menus</b> .....	<b>37</b>
How to Use the Menus .....	37
Example of Menu Operation .....	38
Enlarging a Menu Display .....	40
Menu List .....	41



<b>Taking Pictures</b> .....	<b>44</b>
Changing the Mode .....	44
Selecting the Capture Mode .....	44
Displaying Shooting Information in Capture Mode .....	45
Letting the Camera Set the Functions (Auto Select Mode) .....	47
Using the Help Function .....	48
Setting the Functions (Program Mode) .....	49
Selecting the Picture Mode According to the Shooting Scene (Picture Mode) .....	50
Taking Pictures of Dark Scenes (Night-Scene Mode) .....	52
Taking Landscape Views (Landscape Mode) .....	53
Taking Portrait Pictures (Portrait Mode) .....	53
Taking Movies (Movie Mode) .....	54
Using the Zoom .....	56
Using the Self-Timer .....	58
Continuous Shooting (Continuous Shooting Mode) .....	59
Using the Remote Control Unit (optional) .....	60
Taking Pictures with Color Filters (Digital Filter Mode) .....	61
Taking Two-in-One Pictures (Two-in-One Mode) .....	62
Taking Panorama Pictures (Panorama Assist Mode) .....	63
<b>Setting the Shooting Functions</b> .....	<b>65</b>
Selecting the Focus Mode .....	65
Selecting the Flash Mode .....	67
Selecting the Recorded Pixels .....	68
Selecting the Quality Level .....	69
Selecting the Image Quality .....	70
Adjusting the White Balance .....	71
Changing the Focusing Area .....	73
Setting the Light Metering Mode to Determine the Exposure (AE Metering) .....	74
Setting the Sensitivity .....	75
Setting the Frame Rate .....	76
Setting the Instant Review Time (Instant Review) .....	77
Setting the Image Sharpness (Sharpness) .....	78
Setting the Color Saturation (Saturation) .....	79
Setting the Image Contrast (Contrast) .....	80
Setting the Exposure (EV Compensation) .....	81
<b>Saving the Settings</b> .....	<b>82</b>
Saving the Menu Items (Memory) .....	82
<b>Recording and Playback of Sound</b> .....	<b>84</b>
<b>Recording Sound (Voice Recording Mode)</b> .....	<b>84</b>
<b>Playing Back Sound</b> .....	<b>85</b>
<b>Adding Sound (Voice Memo) to Images</b> .....	<b>86</b>
Recording a Voice Memo .....	86
Playing Back a Voice Memo .....	88

---

<b>Playing Back Images</b> .....	<b>90</b>
Playing Back Still Pictures .....	90
Zoom Display .....	90
Playing Back Movies .....	92
Displaying Shooting Information in Playback Mode .....	93
Nine Image Display .....	94
Slideshow .....	95
<b>Deleting</b> .....	<b>96</b>
Deleting Individual Images or Sounds .....	96
Deleting All Images .....	98
Protecting Images and Sounds from Deletion (Protect) .....	99
<b>Viewing Images on a TV</b> .....	<b>101</b>
Using the Remote Control Unit (optional) to View the Previous or the Next Image .....	102
<b>Setting the Printing Service (DPOF)</b> .....	<b>103</b>
Printing Single Images .....	103
Printing All Images .....	105
<b>Direct Printing Using PictBridge</b> .....	<b>106</b>
Connecting the Camera to the Printer .....	106
Printing Single Images .....	107
Printing All Images .....	108
Printing Using the DPOF Settings .....	108
Disconnecting the Camera from the Printer .....	109
<b>Editing Images</b> .....	<b>110</b>
Changing the Image Size and Quality .....	110
Editing Pictures with Digital Filters .....	112
<b>Copying Files</b> .....	<b>114</b>
<b>Settings</b> .....	<b>116</b>

---

<b>Camera Settings</b> .....	<b>116</b>
Formatting an SD Memory Card or the Built-in Memory .....	116
Changing the Sound Settings .....	117
Changing the Date and Time .....	118
Setting the World Time .....	120
Changing the Start-up Screen, Background Color and Screen Effects .....	122
Changing the Display Language .....	124
Adjusting the Brightness of the LCD Monitor .....	124
Changing the Video Output Format .....	125
Changing the USB Connection Mode .....	126
Setting Auto Power Off .....	127
Resetting to Default Settings (Reset) .....	127
Registering Functions .....	128

---

<b>List of City Codes .....</b>	<b>130</b>
<b>Optional Accessories .....</b>	<b>131</b>
<b>Messages .....</b>	<b>132</b>
<b>Troubleshooting.....</b>	<b>134</b>
<b>Main Specifications .....</b>	<b>136</b>
<b>WARRANTY POLICY .....</b>	<b>140</b>

**Memo**

# Contents of the Operating Manual

This operating manual contains the following chapters.

## 1 Getting Started

This chapter explains what you need to do after purchasing the camera before you start taking pictures. Be sure to read it and follow the instructions.

## 2 Quick Start

This chapter explains the simplest way to take pictures and play back images. Use it if you want to start taking pictures straightaway.

## 3 Common Operations

This chapter explains common operations such as the functions of the buttons and how to use the menus. For more details, refer to the respective "Taking Pictures", "Recording and Playback", "Playback/Deleting/Editing" and "Settings" chapters.

## 4 Taking Pictures

This chapter explains the various ways of capturing images and how to set the relevant functions, including how to change the Capture mode.

## 5 Recording and Playback of Sound

This chapter explains how to record sound only or add a sound (voice memo) to an image, and how to play back voice memos.

## 6 Playback/Deleting/Editing

This chapter explains how to view images on the camera or on a TV, how to delete and resize images, and how to print images by connecting the camera directly to a printer.







## 7 Settings

This chapter explains how to set the camera-related functions.

## 8 Appendix

This tells you about the messages displayed on the LCD monitor and what to do in the event of trouble.

The meanings of the symbols used in this operating manual are explained below.

	indicates the reference page number for an explanation of the related operation.
	indicates information that is useful to know.
	indicates precautions to be taken when operating the camera.
	The icons above the title show the Capture modes that can activate the function. Ex.)   
<b>Setting the Image Sharpness (Sharpness)</b>	

1

2

3

4

5

6

7

8

## Checking the Contents of the Package



Camera  
Optio S45

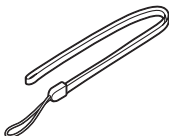

Strap  
O-ST20 (\*)

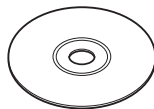

Software (CD-ROM)  
S-SW32

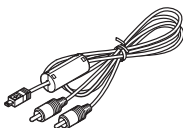

AV cable  
I-AVC7 (\*)

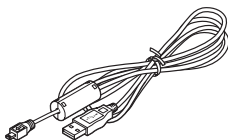

USB cable  
I-USB7 (\*)

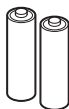

Two AA alkaline batteries

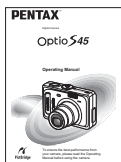

Operating Manual  
(this manual)

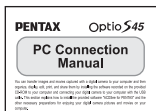

PC Connection Manual

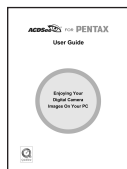

ACDSee for PENTAX  
User Guide

Items marked with an asterisk (\*) are also available as optional accessories. For other optional accessories, refer to "Optional Accessories" (p.131).

# Names of Parts

## Front

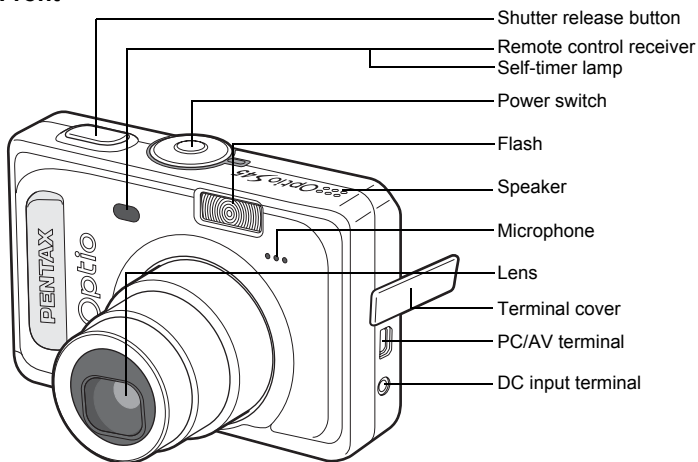

## Back

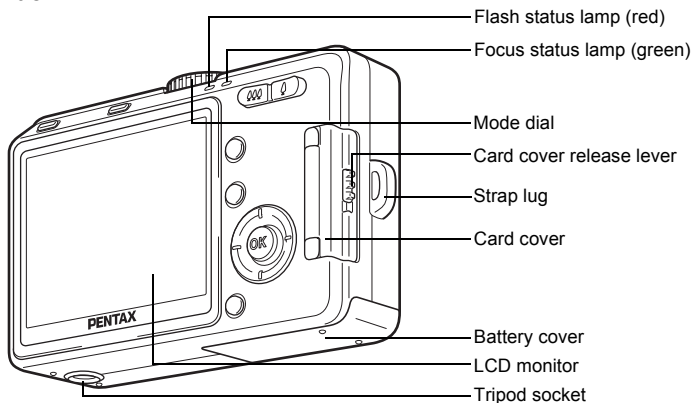

# Names of Operating Parts

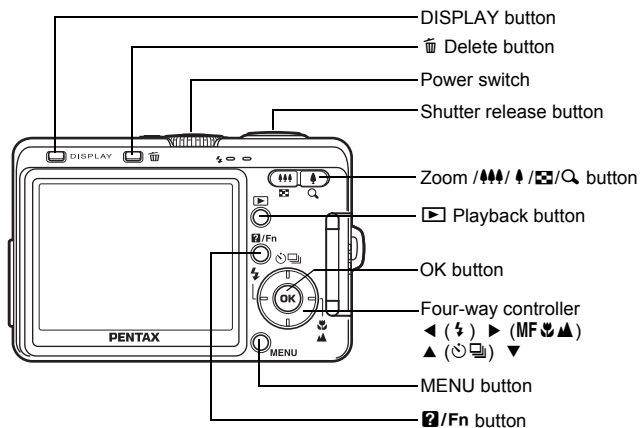

## Guide Indications

A guide to available button operations appears on the LCD monitor during operation.

The buttons are indicated as shown below.

Four-way controller (▲)	▲
Four-way controller (▼)	▼
Four-way controller (◀)	◀
Four-way controller (▶)	▶
MENU button	

Zoom / [Digital Zoom] / [Macro] / [Macro] button	
When digital zoom is enabled	
DISPLAY button	
Delete button	
OK button	
[Fn] button	



## Attaching the Strap

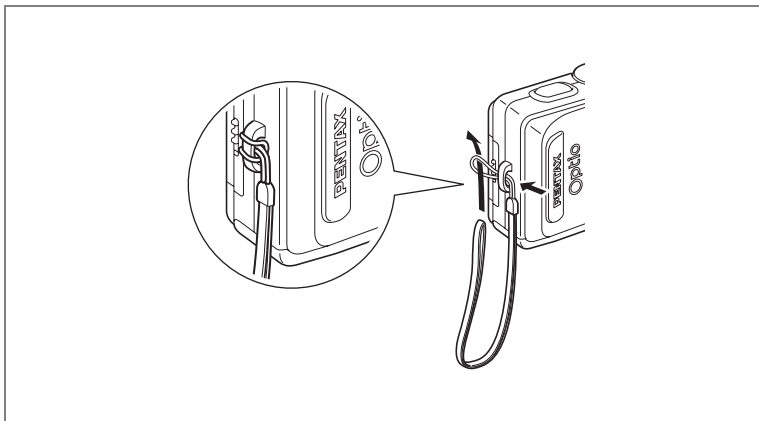

Pass the narrow end of the strap through the strap lug and pass the other end through the loop.

# Powering the Camera

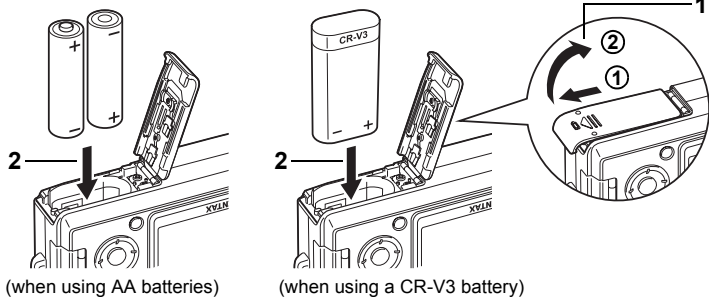

## Installing the Batteries

Insert the batteries in the camera. Use two AA alkaline, AA lithium, AA Ni-MH, or AA nickel manganese batteries or one CR-V3 battery.

### 1 Open the battery cover.

Slide the battery cover in the direction indicated by the arrow ① and flip the cover open ②.

### 2 Insert the batteries according to the (+) and (-) indicators on the battery chamber.

### 3 Close the battery cover and slide it back into place to lock it.



If you intend to use the camera continuously for a long period, use of the AC adapter D-AC5 (optional) is recommended. (p.18)



- AA alkaline, AA lithium, AA nickel manganese and CR-V3 batteries are not rechargeable.
- Do not open the battery cover or remove the batteries when the camera is turned on.
- If you do not intend to use the camera for a long time, remove the batteries, otherwise the batteries may leak.
- The "Battery depleted" error message may appear when you turn on the power after purchasing the camera or after replacing the batteries if the batteries had been removed for a long time. However, this is not an error. Wait a short period and then turn the power switch on again, the power should come on normally. If this happens, the date and time, recorded pixels and other settings may be initialized, reset the various settings according to the procedures in "Setting the Shooting Functions" (p.65 to 81) and "Camera Settings" (p.116 to 129).
- Insert the batteries correctly. If the batteries are incorrectly oriented, malfunction may result. Also, carefully clean the batteries' terminals.

## • Number of Recordable Images and Playback Time (at 23°C with new batteries)

The following shows the number of shots and playback time possible when using various batteries.

Battery Type	Image Storage Capacity*1 (using the flash for 50% of shots)	Playback Time*2
CR-V3	370 pictures	450 minutes
AA Ni-MH batteries	230 pictures	250 minutes
AA nickel manganese batteries	90 pictures	180 minutes
AA alkaline batteries	30 pictures	50 minutes

- \*1 The image storage capacity is a guideline based on CIPA standard measurement conditions, and may vary depending on actual shooting conditions of use. (Measuring conditions: LCD monitor is on, 50% flash use, 23°C.)
- \*2 The playback times are a guideline based on PENTAX measuring conditions and may vary depending on the actual shooting conditions of use.



- In general, battery performance temporarily deteriorates as the temperature decreases. When using the camera in a cold environment, keep it warm by putting it in your pocket or inside your coat. Battery performance that has deteriorated due to low temperature will be restored when the battery is returned to room temperature.
- Due to the characteristics of AA alkaline batteries, camera performance may deteriorate. AA alkaline battery is not recommended except for emergencies.
- Due to the characteristics of AA alkaline and AA nickel manganese batteries, camera performance may deteriorate at low temperatures. Use of other batteries (such as CR-V3) is recommended when using the camera at low temperatures.
- Be sure to take spare batteries with you when traveling abroad or to a cold region, or if you intend to take a lot of pictures.

## • Battery Level Indicator

You can check the battery level by the symbol on the LCD monitor.

	(lit green)	: Adequate power remains.
↓		
	(lit yellow)	: Battery is running very low.
↓		
	(lit red)	: Battery is exhausted.
↓		
[Battery Depleted]		: The camera will turn off after the message appears.



When using AA nickel manganese batteries, the battery strength may not be properly displayed due to the characteristics of this kind of battery. The battery level indicator may show even after using the batteries for a long time. The camera also may turn off, without warning while the battery level indicator still shows .

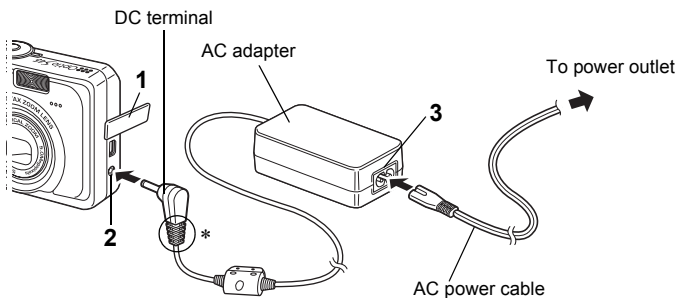

## Using the AC Adapter (optional)

If you intend to use the LCD monitor for a long time or connect the camera to a PC, use of the AC adapter D-AC5 is recommended.

- 1 Make sure that the camera is turned off and open the terminal cover.**
- 2 Connect the DC terminal on the AC adapter to the DC input terminal on the camera.**
- 3 Connect the AC power cable to the AC adapter.**
- 4 Plug the AC power cable into the power outlet.**



- Make sure that the camera is turned off when connecting or disconnecting the AC adapter.
- Make sure that the AC power cable and connecting cable are inserted securely. The data may be lost if the cable becomes disconnected while you are taking pictures.
- If the terminal cover on the camera gets caught in the grooves of the DC terminal (indicated by \* in the illustration), the DC terminal may become disconnected. Take care that the grooves on the DC terminal are not in a position to catch on the terminal cover when using the AC adapter.
- To avoid the risk of fire or electric shock when using the AC adapter, be sure to read "FOR SAFE USE OF YOUR CAMERA" (p.1).
- Be sure to read the operation manual accompanying the AC adapter D-AC5 before using the adapter.
- The batteries inside the camera cannot be recharged by connecting the AC adapter.

## Using the AC Adapter Overseas

AC adapter D-AC5 (optional) is designed to switch automatically to the voltage (100-240V) and frequency (50Hz, 60Hz) of the electricity supply in the country or region where used.

However, electrical socket shapes differ depending on the country or region. Before traveling abroad, you are advised to check the socket shape in your destination (see “Main Socket Types in the Major Countries and Regions of the World” (p.20)) and take an appropriately shaped adapter plug with you.

The socket shape does not affect the charging method.

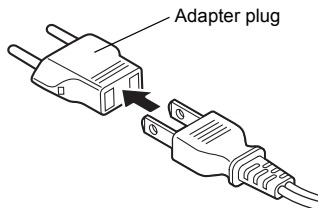

- Use of an off-the-shelf transformer may lead to defective operation.
- Unplug the adapter plug from the power outlet when the battery charging stand is not in use.

Type	A	B	BF	C	S
Shape					
Adapter plug	—				

## Main Socket Types in the Major Countries and Regions of the World

1

Getting Started

		A	B	BF	C	S
North America	U.S.A., Canada	✓				
Europe, Former Soviet Union	Iceland, Ireland, Italy, Ukraine, Austria, Netherlands, Kazakhstan, Greece, Sweden, Denmark, Germany, Norway, Hungary, Finland, France, Belarus, Belgium, Rumania, Russia				✓	
	U.K.		✓	✓		
	Spain	✓			✓	
	Switzerland, Poland, Portugal		✓		✓	
Asia	Taiwan, Japan	✓				
	Sri Lanka, Maldives		✓			
	Nepal, Bangladesh, Mongolia				✓	
	Vietnam	✓			✓	
	India, Indonesia, Pakistan, Macau		✓		✓	
	Thailand	✓		✓	✓	
	Korea	✓	✓		✓	
	Philippines	✓			✓	✓
	Singapore, Hong Kong		✓	✓		
	China	✓	✓	✓	✓	✓
	Malaysia		✓	✓	✓	
Oceania	Australia, Tonga, New Zealand, Fiji					✓
	Guam	✓				
	Tahiti				✓	
Central and South America	Colombia, Jamaica, Haiti, Panama, Bahamas, Puerto Rico, Venezuela, Mexico	✓				
	Brazil, Peru	✓			✓	
	Chile		✓		✓	
	Argentina			✓	✓	✓
Middle East	Israel, Iran				✓	
	Kuwait		✓		✓	
	Jordan		✓	✓		
Africa	Canary Islands, Guinea, Mozambique, Morocco				✓	
	Kenya, South Africa		✓		✓	
	Algeria	✓	✓	✓		
	Egypt		✓	✓	✓	
	Zambia, Tanzania		✓	✓		

# Installing the SD Memory Card

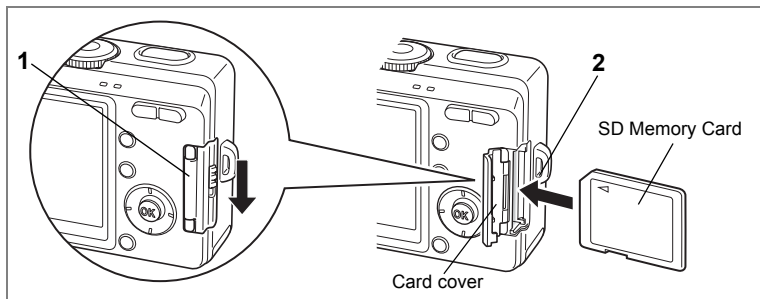

This camera uses an SD Memory Card. Captured images are recorded on the SD Memory Card if a card is inserted (☐ appears on the LCD monitor) or in the built-in memory if no card is inserted (📷 appears on the LCD monitor). Make sure that the camera is turned off before inserting or removing the SD Memory Card.

- 1 Press down on the card cover release lever in the direction indicated by the arrow.**  
Lift your finger, and the card cover opens.
- 2 Insert the SD Memory Card so the label is facing toward the LCD monitor and push the card in until it clicks.**
- 3 Close the card cover.**

To remove the card, eject the card by pressing it in the direction indicated by the arrow and pull it out.



The number of recordable images varies depending on the capacity of the SD Memory Card or built-in memory and the selected image size and quality. (p.24)



Be sure to format unused cards or cards that have been used on another camera. Refer to “Formatting an SD Memory Card or the Built-in Memory” (p.116) for instructions on formatting.

## Data Backup

Very occasionally, malfunction of the camera may cause data stored in the built-in memory to become unreadable. As a backup measure, we recommend that you download important data to a PC or store the data in a media other than the built-in memory.

## Precautions When Using an SD Memory Card

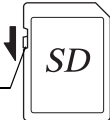
- Make sure that the camera is turned off before opening or closing the card cover.
- The SD Memory Card is equipped with a write-protect switch. Setting the switch to [LOCK] protects the existing data by prohibiting recording of new data, deletion of existing data or formatting of the card.  
  
☒ appears on the LCD monitor when the card is write-protected.
- Care should be taken if you remove the SD Memory Card immediately after using the camera, as the card may be hot.
- Do not remove the SD Memory Card or turn the camera off while data is being recorded on the card, images or voice memos are being played back, or the camera is connected to a PC with the USB cable as this may cause the data to be lost or the card to be damaged.
- Do not bend the SD Memory Card or subject it to violent impact. Keep it away from water and store away from high temperature.
- Do not remove the SD Memory Card during formatting as this may damage the card and render it unusable.
- The data on the SD Memory Card may be deleted in the following circumstances. PENTAX does not accept any liability for data that is deleted
  - (1) when the SD Memory Card is mishandled by the user.
  - (2) when the SD Memory Card is exposed to static electricity or electrical interference.
  - (3) when the card has not been used for a long time.
  - (4) when the card is ejected, the AC adapter is disconnected or the batteries are removed while the data on the card is being recorded or accessed.
- The SD Memory Card has a limited service life. If it is not used for a long time, the data on the card may become unreadable. Be sure to make a backup of important data on a PC.
- Avoid using or storing the card where it may be exposed to static electricity or electrical interference.
- Avoid using or storing the card in direct sunlight or where it may be exposed to rapid changes in temperature or to condensation.
- When using an SD Memory Card with a slow recording speed, recording may stop while you are taking movies even when there is adequate space in the memory, or shooting and playback may take a long time.
- For information on compatible memory cards, visit the PENTAX website or contact your nearest PENTAX customer service center.



## Recorded Pixels and Quality

Choose the number of recorded pixels and quality best suited to your purpose.

Higher quality levels and numbers of recorded pixels produce clearer images for printing, but the resulting increase in data volume reduces the total number of pictures that can be taken.

Choose the appropriate number of recorded pixels and quality level on the [  Rec. Mode ] menu.

Selecting the Recorded Pixels  p.68

Selecting the Quality Level  p.69

Selecting the Image Quality  p.70

### ● Appropriate Number of Recorded Pixels According to Use

2304×1728	Higher quality ↑	High quality photo printing, A4 size or larger prints, editing or creating images etc.
2048×1536		
1600×1200		
1024×768		
640×480		

The default setting is 2304×1728.

### ● Appropriate Quality According to Use

★★★	Best	Lowest compression rate. Suitable for photo prints.
★★	Better	Standard compression rate. Suitable for viewing the image on a computer screen.
★	Good	Highest compression rate. Suitable for attaching to e-mails or creating websites.

The default setting is ★★ (Better).

## ● Appropriate Quality According to Use (Auto Select Mode)

Superior (4MB: 2304×1728 ★★★)	Higher quality ↑	High quality photo printing, A4 size or larger prints, editing or creating images etc.
Super (4MB: 2304×1728 ★★)		
Normal (3MB: 2048×1536 ★★)		
Economy (0.3MB: 640×480 ★★)		

The default setting is Super.



The number of recorded pixels and quality are set together in ☺ (Auto Select) mode. (p.70)

## ● Approximate Number of Recordable Images by Size and Quality

When using the built-in memory (11MB)

Quality Level Recorded Pixels	★★★ Best	★★ Better	★ Good	Movie (320×240)	Sound
2304×1728	4	8	12	49 sec. (15 fps)	11 min.
2048×1536	5	9	14		
1600×1200	8	15	21	25 sec. (30 fps)	
1024×768	19	36	48		
640×480	44	69	92		

When using the SD memory card (128MB)

Quality Level Recorded Pixels	★★★ Best	★★ Better	★ Good	Movie (320×240)	Sound
2304×1728	49	96	138	9 min. 12 sec. (15 fps)	2 h. 13 min.
2048×1536	62	113	166		
1600×1200	104	178	250	4 min. 45 sec. (30 fps)	
1024×768	227	417	554		
640×480	500	782	1043		

- The above table is based on standard shooting conditions specified by PENTAX and may vary depending on the subject, shooting conditions, capture mode, SD Memory Card, etc.

# Turning the Camera On and Off

1

Getting Started

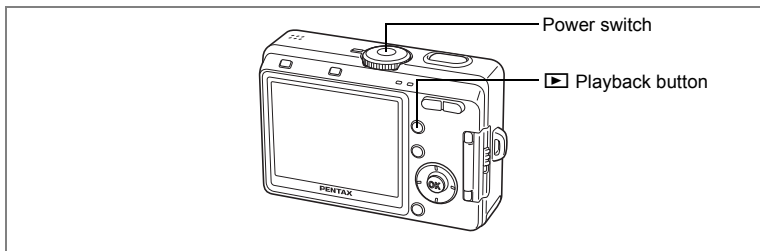

## 1 Press the power switch.

The camera turns on.

The lens cover opens and the lens extends when the camera is turned on.

## 2 Press the power switch again.

The camera turns off.

Switching between Capture Mode and Playback Mode  
☞ p.44

Taking Pictures ☞ p.44

The “Battery depleted” error message may appear when you turn on the power after purchasing the camera or after replacing the batteries if the batteries had been removed for a long time. However, this is not an error. Wait a short period and then turn the power switch on again, the power should come on normally. If this happens, the date and time, recorded pixels and other settings may have been initialized, reset the various settings according to the procedures in “Setting the Shooting Functions” (p.65 to 81) and “Camera Settings” (p.116 to 129).

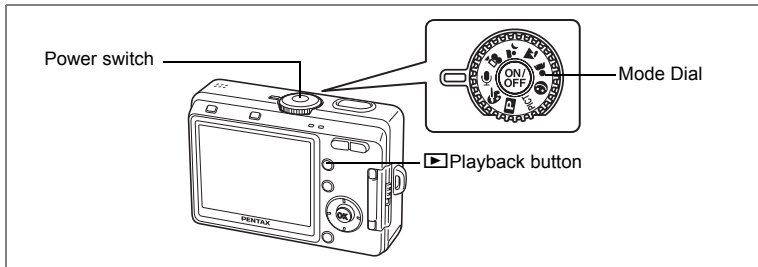

## Playback Only Mode

When the camera is turned on in the Playback Only mode, the lens does not extend. Use this mode when you want to immediately play back images or audio data without shooting pictures. The mode does not switch to Capture mode even if the shutter release button is pressed.

### 1 Press the power switch while pressing the Playback button.

The camera turns on in the Playback Only mode. The lens does not extend.



- To switch from Playback Only mode to Capture mode, press the power switch to turn the camera off, then press it again to turn it on.
- In the Playback Only mode,  is displayed when playing back images.
- In the Capture mode, pressing and holding the Playback button for two seconds or more switches the mode to the Playback mode, and the lens is retracted. The Playback mode is different from the Playback Only mode, pressing the Playback or shutter release buttons again, or turning the mode dial switches the mode to the Capture mode.

Playing Back Still Pictures  p.90

## Voice Recording Only Mode

Voice Recording Only mode is for recording sound only. The lens does not extend in this mode.

You can use the camera as a voice recorder.

### 1 Set the mode dial to and press the power switch.

The camera turns on in Voice Recording Only mode. The lens does not extend.



When the mode dial is turned in Voice Recording Only mode, the lens extends and the camera switches to capture status.

Recording Sound (Voice Recording Mode)  p.84

# Initial Setting

After purchasing the camera, before using it for the first time set the language, date and time.

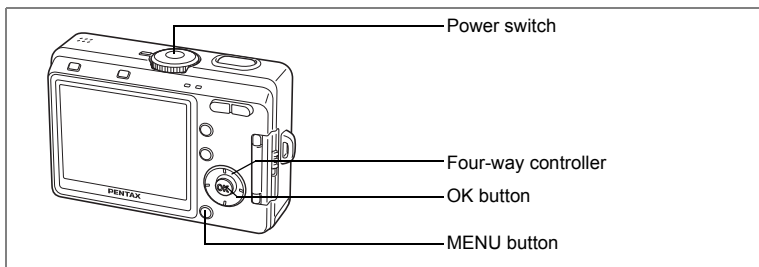

1

Getting Started

## Setting the Display Language

You can choose the language in which the menus, error messages, etc. are displayed from the following: English, French, German, Spanish, Italian, Russian, Korean, Chinese (traditional and simplified) and Japanese.

- 1 Turn the camera on.**
- 2 Use the four-way controller (◀▶) to choose the display language.**  
The default setting is English.
- 3 Press four-way controller (▼).**  
The frame moves to [City].
- 4 Use four-way controller (◀▶) to choose the desired city.**
- 5 Press four-way controller (▼).**  
The frame moves to [DST] (Daylight Saving Time).
- 6 Use four-way controller (◀▶) to select  (On) or  (Off).**
- 7 Press the OK button.**

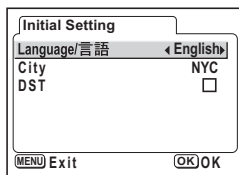

The Date Adjust screen appears (see next page). Continue with the date settings.

If you have set the wrong language by mistake, use the following procedure to reset the language.

- 1 Press the **MENU** button twice.
- 2 Press the four-way controller (▶) twice.
- 3 Press the four-way controller (▲▼) to choose the [Language/言語].
- 4 Use the four-way controller (◀▶) to choose the display language.
- 5 Press the **OK** button.

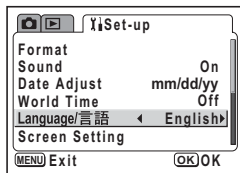

The language is reset, and the screen switches to the Capture mode. The date and time settings are not finished yet, set them following the procedure on (p.118) "Changing the Date and Time".

## Setting the Date and Time

Set the current date and time and the display style.

- 1 Press the four-way controller (▲▼), to select the date display style.

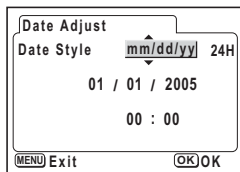

- 2 Press the four-way controller (▶).

The frame moves to [24H].

- 3 Press the four-way controller (▲▼), to select the time display style.

Select [12H] to display the time in a 12 hour format, or select [24] to display the time in a 24 hour format.

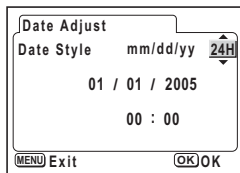

- 4 Press the four-way controller (▶).

The frame moves to month.

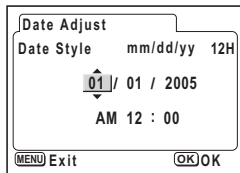

## 5 Press the four-way controller (▲▼) to change the month.

Set the day and year in the same manner. (Pressing the four-way controller (◀) moves the frame to the previous item.)

If you select [12H] in step 3, the setting switches between AM and PM corresponding to the time.

## 6 Press the OK button.

The camera is ready to take pictures.



- When you finish the settings and press the OK button, the camera clock is reset to 00 seconds.
- To set the exact time, press the OK button when the time signal (on the TV, radio, etc.) reaches 00 seconds.

The initial setting is completed. The Initial Setting screen will not appear when you use the camera next time.



- When the Initial Setting or Date Adjust screen is displayed, you can cancel the setting operation and switch to Capture mode by pressing the MENU button. In this case, the Initial Setting or Date Adjust screen will appear next time you turn the camera on.
- You can change the settings after they have been made. Refer to the following pages for operation procedures.  
 [Language]: “Changing the Display Language” (p.124)  
 [City] [DST]: “Setting the World Time” (p.120)  
 [Time]: “Changing the Date and Time” (p.118)
- [Video Output Format] is automatically set corresponding to the display language setting as shown in the table below. If the format of your region is different, reset the setting following the instruction “Changing the Video Output Format” (p.125).

Language	Video Output
Japanese	NTSC
English	NTSC
French (Français)	PAL
German (Deutsch)	PAL
Spanish (Español)	PAL
Italian (Italiano)	PAL
Traditional Chinese (中文繁體)	PAL
Simplified Chinese (中文简体)	PAL
Russian (Русский)	PAL
Korean (한국어)	NTSC

# Quick Start

## Taking Still Pictures

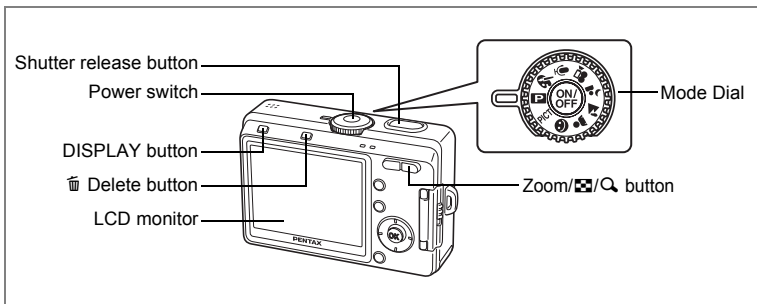

The standard procedure for taking still pictures is described below. The flash fires automatically depending on the light conditions.

- 1 Press the power switch.**
- 2 Set the mode dial to **P**.**
- 3 Check the image on the LCD monitor.**

The camera turns on.

The camera turns on.

The focus frame in the middle of the LCD monitor indicates the zone of automatic focusing. You can change the captured area by pressing the Zoom/AAA/▲ button.

▲ : enlarges the subject.

AAA : enlarges the area captured by the camera.

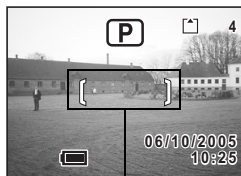

Focus frame



Be sure to check the focusing area on the LCD monitor.

- 4 Press the shutter release button halfway.**
- 5 Press the shutter release button fully.**

The focus frame turns green if the subject is in focus.

The image appears on the LCD monitor for 0.5 second (Instant Review) and is recorded on the SD Memory Card or in the built-in memory. The green and red lamps on the upper part of the back of the camera blink alternately while the image is being recorded.



## Using the Shutter Release Button

The shutter release button works in a two-step action as follows.

### Press halfway

The focus and exposure are locked when the shutter release button is pressed lightly (halfway). The shutter speed and aperture settings only appear on the LCD monitor when the shutter release button is pressed halfway. The following information is indicated on the LCD monitor and by the focus status and flash status lamps when the shutter release button is pressed halfway.

#### 1. Focus frame

The focus frame lights green at the focus position if the subject is in focus. The frame does not appear if the subject is out of focus.

#### 2. Status lamps

	Focus status lamp (green)	Flash status lamp (red)
Lit	Subject is in focus	Flash is charged
Blinks	Subject is out of focus	Flash is charging

Pictures cannot be taken while the flash is charging.

### Press down fully

Press the shutter release button all the way down (fully) to take a picture.

[Poor focusing conditions]

The camera may not be able to focus under the following conditions. In this case, lock the focus on an object the same distance away as the subject (by pressing the shutter release button halfway), then aim the camera at your subject and press the shutter release button fully.

- Objects that lack contrast such as a blue sky or white wall
- Dark places or objects, or conditions that prevent light being reflected back
- Horizontal lines or intricate patterns
- Fast moving objects
- When there is an object in the foreground and an object in the background in the same picture
- Strongly reflected light or strong backlighting (bright background)

## Instant Review

The Instant Review default setting is 0.5 second. When the display time is set to one second or longer, you can delete the image by pressing the  Delete button in the instant review display, selecting [Delete] when the [Delete] menu appears and pressing the OK button. (p.96)

Setting the Instant Review Time  p.77

# Quick Start

## Playing Back Still Pictures

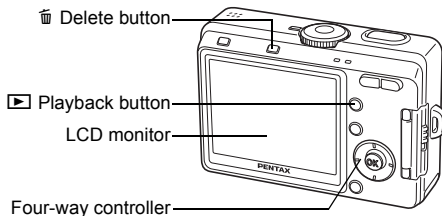

### Playing Back Images

You can display the still picture you have just taken.





- 1 Press the  **Playback button** after taking a picture.

The mode changes to the Playback mode and the image appears on the LCD monitor. Pressing and holding the Playback button for two seconds or more switches the mode to the Playback mode, and the lens is retracted. After viewing the image, press the Playback or shutter release button again or turning the mode dial to take another picture.



### Playing Back the Previous or Next Image

Still pictures can be played back one at a time, proceeding either forward or backward.

- 1 Press the  **Playback button** after taking a picture.  
The image appears on the LCD monitor.
- 2 Press the four-way controller (  ).



displays the previous image.



displays the next image.

## Rotating the Displayed Image

### 1 Press the Playback button after taking a picture.

The image appears on the LCD monitor.

### 2 Press the four-way controller ()





The image is rotated 90° clockwise each time the button is pressed.





- Only still images taken with this camera can be rotated.
- Zoom display, nine-image display and voice memo recording/playing function can be used with rotated images. However, images rotated in zoom playback are returned to their normal orientation.

## Deleting the Displayed Image

You can delete the image displayed on the LCD monitor by pressing the  Delete button, using the four-way controller () to select [Delete] and pressing the OK button.

Press the  Playback button again or press the shutter release button halfway to return to the Capture mode.







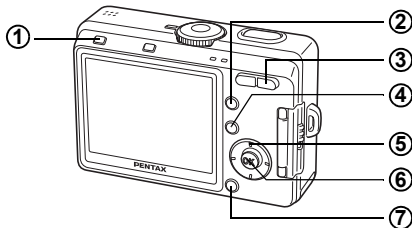



- The last picture taken appears on the LCD monitor when you switch to the Playback mode.
- You can enlarge the image by pressing the Zoom /  button.
- If there are no images stored, the [No image/sound] message appears.

## Using the Button Functions



## Capture Mode

- ① DISPLAY button**  
Changes the information displayed on the LCD monitor. (☞p.45)
- ②  Playback button**  
Switches to the Playback mode. Press it and hold it down to retract the lens. (☞p.32)
- ③ Zoom button**  
You can change the shooting area by pressing the Zoom button. (☞p.56)
- ④  /Fn button**  
Displays the Help screen in  mode. (☞p.48)  
Sets the function assigned by [Fn Setting] on the [Yi Set-up] menu in any mode other than ,  or  mode. (☞p.128)
- ⑤ Four-way controller**  
**[Used for all modes]**  
(◀) Changes the flash mode (except for Movie mode). (☞p.67)  
(▶) Changes the focus mode. (☞p.65)  
(▲) Selects self-timer mode, remote control mode and continuous shooting mode (☞p.58 - p.60)  
**[When using PICT, digital filter mode]**  
(▼) Selects the shooting effect. (☞p.50, 61 - 63)  
**[When using MF mode]**  
(▲▼) Adjusts the focus. (☞p.66)
- ⑥ OK button**  
Sets a menu item. (☞p.37)
- ⑦ MENU button**  
Displays the [ Rec. Mode], [ Playback] and [Yi Set-up] menus. (☞p.37)

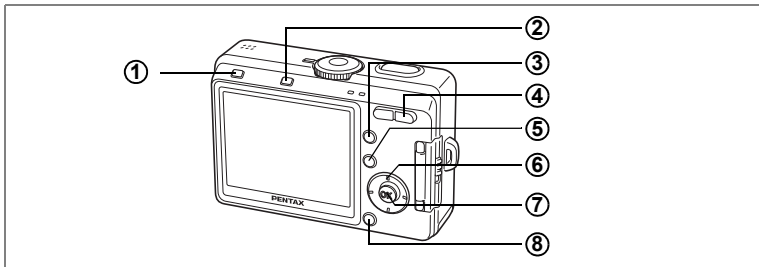

## Playback Mode



- ① DISPLAY button**  
Changes the information displayed on the LCD monitor. (☞p.93)  
Selects all images for printing or protecting on the DPOF screen and Protect screen. (☞p.100, p.105)
- ② Delete button**  
Deletes the image displayed on the LCD monitor. (☞p.96)
- ③ Playback button**  
Switches to the Capture mode. (☞p.32)
- ④ Zoom/Matrix/Quick button**  
Press **Matrix** during normal playback to change the display to nine images.  
Press **Quick** during normal playback to change to a magnified display. (☞p.94)  
Press **Zoom/Matrix/Quick** during zoom playback to change the size of the Zoom Display image displayed on the LCD monitor.
- ⑤ Fn button**  
Displays the Help screen in **Smile** mode.
- ⑥ Four-way controller**  
(▲) Plays back and pauses a movie. (☞p.92)  
Starts playback of a voice memo. (☞p.88)  
(◀▶) Displays the previous or next image. (☞p.32)  
(▼) Rotates the image when pressed in still image playback. (☞p.33)  
Stops playback during playing back movies or voice memos.  
(☞p.88, 92)
- ⑦ OK button**  
Sets a menu item. (☞p.37)  
Starts recording or playing back a voice memo.
- ⑧ MENU button**  
Displays the [Rec. Mode], [Playback] and [Set-up] menus. (☞p.37)

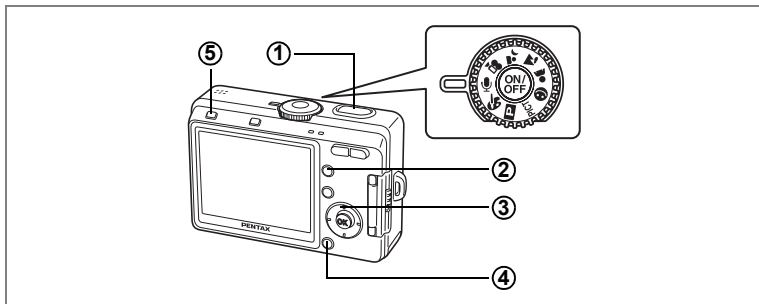

Pressing the **Playback** button does not change the mode to the Capture mode when the camera was turned on in Playback Only mode. To switch from Playback Only mode to Capture mode, press the power switch to turn the camera off, then press it again to turn it on.



## Voice Recording Mode

- ① Shutter release button**  
When pressed, starts recording, and when pressed again, stops recording. (p.84)
- ②  Playback button**  
Switches to the Playback mode. When pressed again, returns to Voice Recording mode. (p.85)
- ③ Four-way controller (in Playback mode)**  
  - (▲) Starts playback. When pressed again, pauses playback. (p.85)
  - (◀▶) Selects previous and next image and sound file before playback.
  - (▼) Stops playback.
- ④ MENU button**  
When pressed during standby or before playback, displays the [ Playback], [ Set-up] menus. (p.42)
- ⑤ DISPLAY button**  
  - When recording sound: The LCD monitor turns off. When pressed again, returns to the recording screen.
  - When playing back sound: When pressed during standby, the display mode changes to the No Icons. When pressed again, returns to the Normal Display.

# Using the Menu

When you press the MENU button, the menus appear on the LCD monitor. You can set functions, save the settings and change the camera settings on these menus.

## How to Use the Menu

When you are making settings from a menu, a guide to operation appears on the LCD monitor.

Ex.) To set the [Quality Level] on the [📷 Rec. Mode] menu

### 1 Press the MENU button.

The menu screen appears. The [📷 Rec. Mode] menu is selected.

### 2 Press the four-way controller (▼).

The frame moves to [Recorded Pixels].

### 3 Press the four-way controller (▼).

The frame moves to [Quality Level].

### 4 Use the four-way controller (◀▶) to change the setting.

The quality changes each time the four-way controller is pressed.

### 5 Press the OK button or the shutter release button.

The setting is saved and the screen returns to capture status.

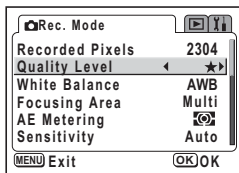
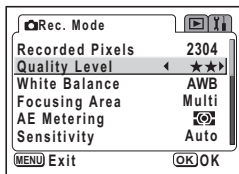
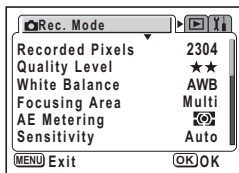

- If you press any buttons before pressing the OK button or the shutter release button to exit the menu, any changes you have made to the settings will not be saved.
- Even after pressing the OK button or the shutter release button to exit the menu, if you turn the camera off incorrectly (such as by removing the batteries while the camera is turned on), any changes you have made to the settings will not be saved.

# Example of Menu Operation

3

Common Operations

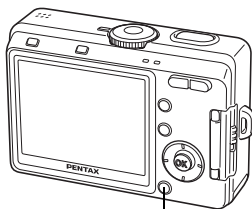

MENU button

MENU



## [📷 Rec. Mode] Menu

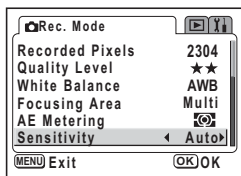
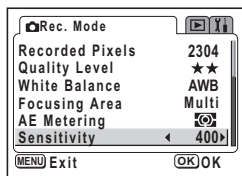
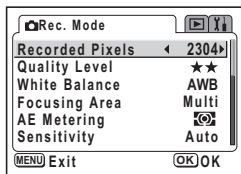
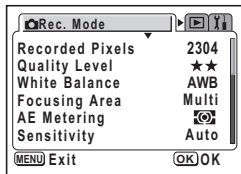

To the next screen



## [▶ Playback] Menu

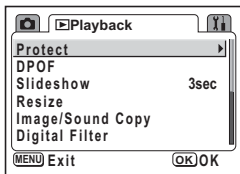
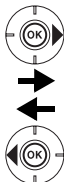
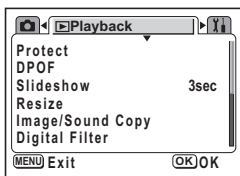

To the next screen

## [ⓧ Set-up] Menu

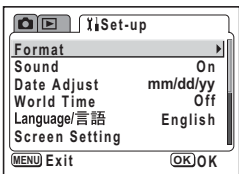
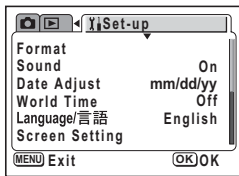



To the next screen



The [📷 Rec. Mode] menu appears when you press the MENU button in Capture mode, and the [▶ Playback] menu appears when you press the MENU button in Playback mode.

## Enlarging a Menu Display

Pressing the zoom button (  ) while a menu is displayed enlarges the menu. Press  to return to the original display.

### Example of Menu Operation

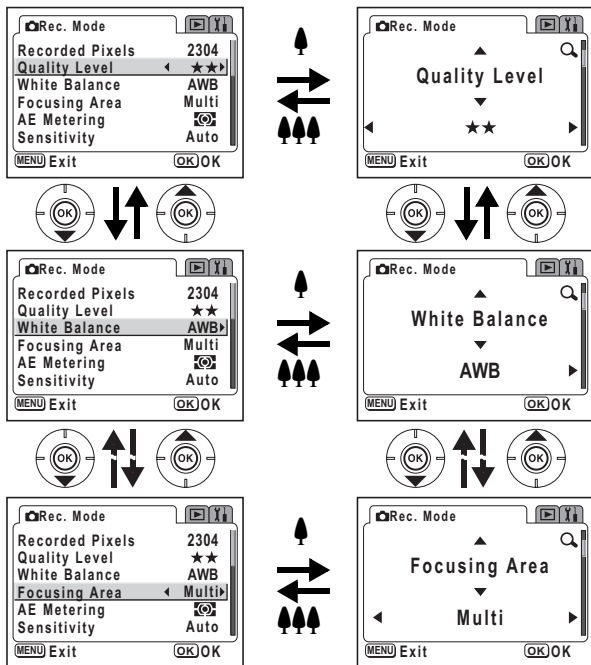

If you turn the camera off while still in enlarged display mode, the next time you turn the camera on and press the MENU button, the menu will be enlarged.

## Menu List

### [📷 Rec. Mode] Menu

Yes ...Adjustable

# ...Any changes made are invalid in **PICT**, 📶 and 👤 modes.

No ...Any changes made are invalid. You can change the setting on the menu, but any changes you make are invalid in actual operation.

Item	Description	Default Setting	☺	📷 PICT 👤 📶 👤 📷	📷	Page
Image Quality	For selecting the number of pixels and image compression rate	Super	Yes	—	—	p.70
Recorded Pixels	For selecting the number of pixels	2304×1728	—	Yes	320×240	p.68
Quality Level	For selecting the image compression rate	★★	—	Yes	No	p.69
White Balance	For adjusting the color balance according to lighting	AWB (Auto)	—	#	Yes	p.71
Focusing Area	For changing the area of the autofocus	Multi (Multiple)	—	Yes	No	p.73
AE Metering	For setting the metering method to determine the exposure	📷 (Multi-segment)	—	Yes	Yes	p.74
Sensitivity	For setting the sensitivity	Auto	—	Yes	No	p.75
Frame Rate	For setting the frame rate	30 fps	—	No	Yes	p.76
Digital Zoom	For taking digital zoom pictures	On	—	Yes	Yes	p.56
Instant Review	For setting the Instant Review time	0.5 sec	—	Yes	No	p.77
Memory	For saving the shooting function settings when the camera is turned off	*	—	Yes	Yes	p.82
Sharpness	For setting the sharpness	Normal	—	#	No	p.78
Saturation	For setting the saturation	Normal	—	#	No	p.79
Contrast	For setting the contrast	Normal	—	#	No	p.80
EV Compensation	For adjusting the exposure between -2.0 and +2.0	±0.0	—	Yes	Yes	p.81

\* Only the flash, digital zoom and file number settings are saved.



- There is no [📷 Rec. Mode] menu in 📷 mode.
- [Image Quality] is the only menu available in ☺ mode.

## [▶ Playback] Menu

Item	Description	Page
Protect	For protecting images from deletion	p.99
DPOF	For setting the printing service to print out images	p.108
Slideshow	For playing back recorded images successively	p.95
Resize	For changing the size of images	p.110
Image/Sound Copy	For copying files from the built-in memory to the SD Memory Card and vice versa	p.114
Digital Filter	For creating a filter effect using filters (red, blue, green, etc.)	p.112
Record Voice Memo	For preventing the voice memo from being recorded while playing back still images, when OFF is selected	p.86
Quick Zoom	For playing back images at the maximum zoom size by pressing the Zoom button only once	p.91
Quick Delete	For displaying the Delete screen with [Delete] highlighted when ON is selected	p.97

## [ⓘ Set-up] Menu

Item	Description	Page
Format	For formatting the SD Memory Card or built-in memory	p.116
Sound	For adjusting the playback volume and setting the type and volume of start-up sound, shutter sound, key operation sound.	p.117
Date Adjust	For adjusting the date, time and date style	p.118
World Time	For setting the world time	p.120
Language/言語	For changing the language in which menus and messages appear	p.124
Screen Setting	For selecting the start-up screen, background color and screen effects	p.122
Brightness Level	For changing the brightness of the LCD monitor	p.124
Video Out	For setting the video output format	p.125
USB Connection	For changing the USB connection mode	p.126
Auto Power Off	For turning off the power automatically after a fixed time	p.127
Fn Setting*	For registering a function on the four-way controller (▲▼◀▶)	p.128
Reset	For returning the camera settings to defaults	p.127

\* The "Fn setting" is not available in the ☺ mode.

**Memo**



3

**Common Operations**

## Changing the Mode

Capture mode is for taking pictures and Playback mode is for playing back or deleting images.

### Switching between Capture Mode and Playback Mode







- To change from Capture mode to Playback mode, press the  Playback button.
- To change from Playback mode to Capture mode, press the  Playback button or press the shutter release button halfway.



In Capture mode, pressing and holding the  Playback button for two seconds or more switches the mode to the Playback mode, and the lens is retracted.

## Selecting the Capture Mode

### Capture Modes

	Program mode	The basic picture-taking mode.	p.49
<b>PICT</b>	Picture mode	You can select the Picture mode according to the shooting scene. There are nine Picture modes to choose from.	p.50
	Auto Select mode	Lets the camera set the functions automatically.	p.47
	Portrait mode	Lets you take portrait-type pictures.	p.53
	Landscape mode	Lets you take landscape views.	p.53
	Night-Scene mode	Lets you take dark scenes such as night views.	p.52
	Movie mode	Lets you take movies.	p.54
	Digital Effect mode	Lets you take pictures with a variety of special effects.	p.61 - 64

- 1** Turn the mode dial and match the indicator with one of the following:

 PICT      .

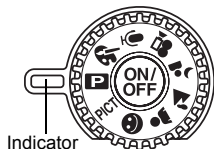

Indicator

## Displaying Shooting Information in Capture Mode

The LCD monitor display changes each time you press the DISPLAY button.

### Normal Display

Shooting information is displayed when the power is turned on.

- |   |                |
|---|----------------|
| 1 Flash mode                            | 2 Drive mode   |
| 3 Focus mode                            | 4 Capture mode |
| 5 Focus frame                           |                |
| 6 Card/Built-in memory                  |                |
| 7 Remaining number of recordable images |                |
| 8 Date and time                         |                |
| 9 Battery level indicator               |                |

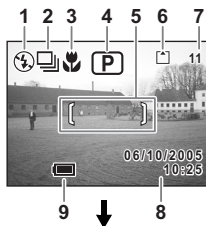

### Histogram Display

The brightness distribution of the image is displayed. The horizontal axis of the histogram shows the brightness (darkest at the left end and brightest at the right end) and the vertical axis shows the number of pixels.

- |                 |                   |
|-----------------|-------------------|
| 1 White balance | 2 Recorded pixels |
| 3 Quality level | 4 Sensitivity     |
| 5 Histogram     | 6 AE metering     |

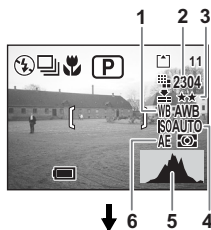

### Grid Display

A grid appears to help you compose your pictures.

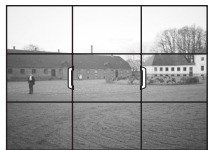



### No Icons

No shooting information is displayed.

- The focus frame appears in Autofocus mode.
- If any of the modes are changed, such as the flash mode, the mode you have changed appears for a few seconds.

### LCD Monitor Off

The LCD monitor turns off.

The LCD monitor cannot be turned off in  or  mode.



LCD Monitor Off

Normal Display

## Using Histogram

A histogram is a graph showing the brightness of an image on the horizontal axis and the number of pixels on the vertical axis (distribution chart of the brightness). The histogram will help you detect the brightness of the image you have taken. For instance, the graph peak tends to appear on the left side for a darker image, and the graph peak tends to appear on the right side for a brighter image. In general, when the exposure meter of your image is well-balanced, the graph peaks tend to appear in the middle. On the contrary, when the exposure meter gets imbalanced tending dark and bright without showing a neutral brightness, the peaks appear not in the middle but on both sides.

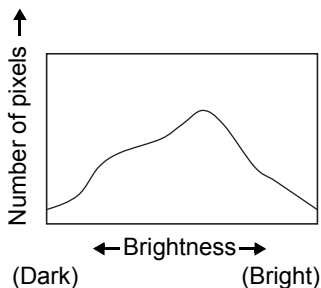

Dark



Neutral

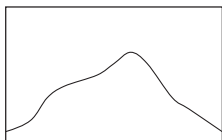

Bright





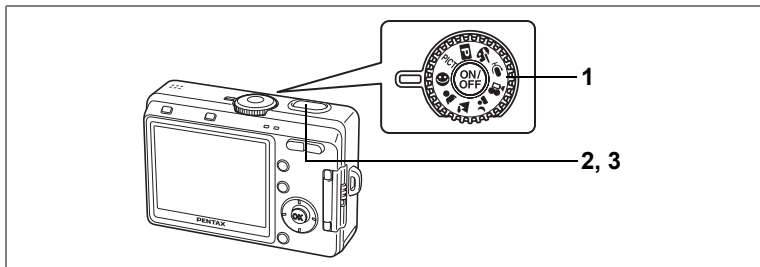

## Letting the Camera Set the Functions (Auto Select Mode)

☺ (Auto Select) mode is the simplest way to take pictures without having to set any functions. The camera automatically chooses the optimal settings for the shooting scene when the shutter release button is pressed halfway.

**1 Set the mode dial to ☺.**

**2 Press the shutter release button halfway.**

The focus frame on the LCD monitor changes to green if the subject is in focus, the settings are selected for the shooting scene automatically recognized by the camera, and one of the following icons appears.

- 🏞️ : The camera chooses the optimal settings for a landscape view.
- 👤 : The camera chooses the optimal settings for a portrait shot.
- 🌃 : The camera chooses the optimal settings for a night view.
- ☺ : This icon appears in all other situations.

**3 Press the shutter release button down fully.**

The picture is taken.



- [Image Quality] is the only item that can be changed on the [📷 Rec. Mode] menu in Auto Select Mode.
- You are recommended to set the mode dial to 🌃 and secure the camera on a tripod etc. when taking night views. If the camera recognizes the scene as the 👤 in the Auto Select Mode, pictures of night views may be dark because the shutter speed is controlled in a range to prevent camera shake.

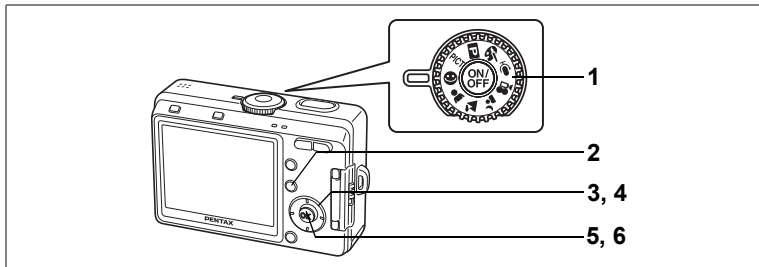

## Using the Help Function

You can display the Help screen while taking or viewing pictures in Auto Select mode. The Help screen describes the function of each button, such as the four-way controller keys and zoom button.

**1 Set the mode dial to ☺.**

**2 Press the /Fn button.**

The Help screen appears on the LCD monitor.

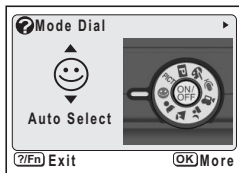

**3 Use the four-way controller (◀▶) to select [Mode Dial], [Four-way Controller] or [Buttons on Back Cover].**

Only [Four-way Controller] and [Buttons on Back Cover] are available in Playback mode.

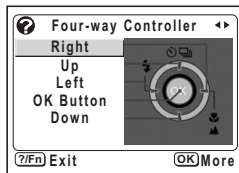

**4 Use the four-way controller (▲▼) to choose the button or mode that you want to be explained.**

**5 Press the OK button.**

The explanation of the button appears.

**6 Press the OK button.**

The camera is ready to take or play back pictures.

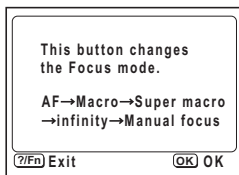

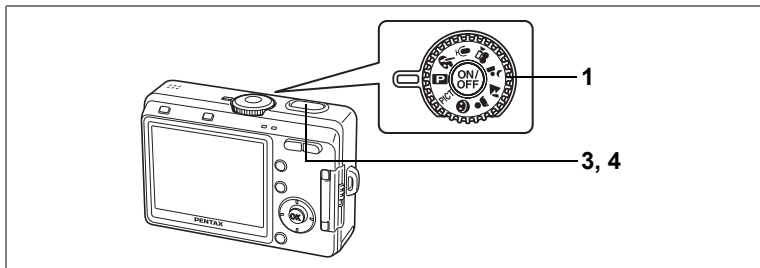

## Setting the Functions (Program Mode)

In **P** (Program) mode, the camera automatically sets the shutter speed and aperture for taking still pictures. However, you can select other functions such as the flash mode or continuous shooting mode.

- 1 Set the mode dial to **P**.**
- 2 Set the functions you want to use.**

Refer to “Setting the Shooting Functions” (p.65 to p.81) for details of how to set the functions.

- 3 Press the shutter release button halfway.**

The focus frame turns green if the subject is in focus.

- 4 Press the shutter release button fully.**

The picture is taken.





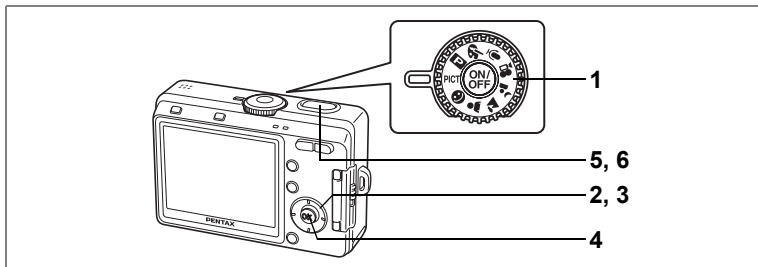





Taking Still Pictures p.30



## Selecting the Picture Mode According to the Shooting Scene (Picture Mode)

You can select the Picture mode according to the shooting scene. There are 9 available modes in Picture mode.

	Flower (default setting)	Lets you take brightly colored flower pictures.
	Self-portrait	Lets you take pictures of yourself or be included in pictures.
	Surf	Lets you take photos against dazzling backgrounds such as beaches.
	Snow	Lets you take photos against dazzling backgrounds such as snow-covered mountains.
	Sunset	Lets you reproduce the beautiful colors of the sunrise or sunset.
	Museum	Lets you take pictures in art galleries and museums where flash photography is prohibited.
	Text	Lets you take clear pictures of text or writing.
	Food	Lets you take appetizing pictures of prepared food.
	Landscape Portrait	Lets you take pictures where both the person in the foreground and the scenery in the background are in focus.

- 1 Set the mode dial to PICT.**
- 2 Press the four-way controller (▼).**  
The screen for choosing a Picture mode appears.

- 3 Use the four-way controller (▲▼◀▶) to choose the Picture mode.**

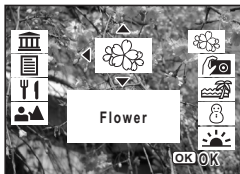

- 4 Press the OK button.**

The Picture mode is selected.

- 5 Press the shutter release button halfway.**

The focus frame turns green if the subject is in focus.



- 6 Press the shutter release button fully.**

The picture is taken.



In Picture mode, the saturation, contrast, sharpness and white balance are automatically set to the optimal settings for each mode. (The setting values can be changed, but they are not reflected in the operation.)

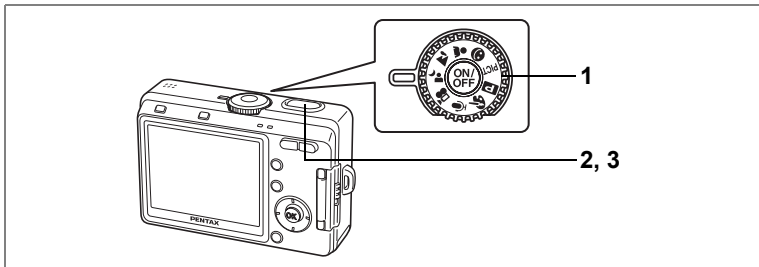

## Taking Pictures of Dark Scenes (Night-Scene Mode)

- 4 You can take pictures of dark scenes, such as nightscapes, with the appropriate settings.



The shutter speed is slower when taking pictures of dark scenes. To prevent camera shake, secure the camera on a tripod or other surface.

- 1 **Set the mode dial to**
- 2 **Press the shutter release button halfway.**  
The focus frame turns green if the subject is in focus.
- 3 **Press the shutter release button fully.**  
The picture is taken.



### Using the Shutter Release Button p.31



- Total recording time will be longer when the picture is taken at slower shutter speed, because the noise reduction activates to reduce noise.
- In the Night Scene Mode, the auto sensitivity has a range of 50 to 200.

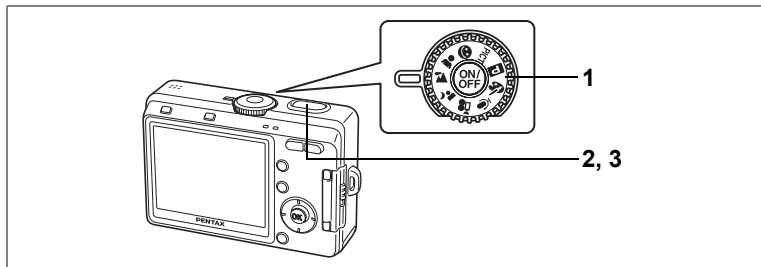

## Taking Landscape Views (Landscape Mode)

This mode lets you take landscape views using the optimal settings.

- 1 Set the mode dial to .**
- 2 Press the shutter release button halfway.**  
The focus frame turns green if the subject is in focus.
- 3 Press the shutter release button fully.**  
The picture is taken.

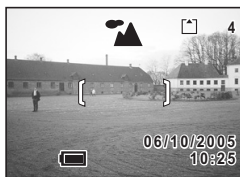

Using the Shutter Release Button  p.31

## Taking Portrait Pictures (Portrait Mode)

This mode lets you capture your subject in natural colors using the optimal settings.

- 1 Set the mode dial to .**
- 2 Press the shutter release button halfway.**  
The focus frame turns green if the subject is in focus.
- 3 Press the shutter release button fully.**  
The picture is taken.



Using the Shutter Release Button  p.31

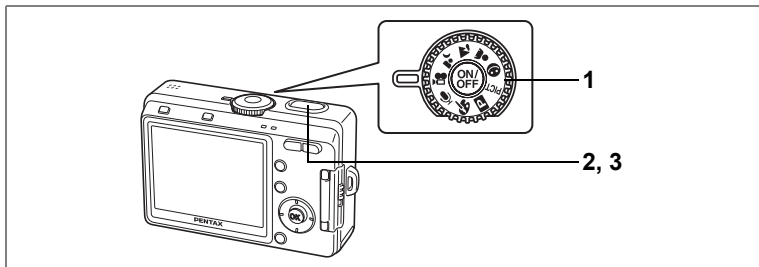

## Taking Movies (Movie Mode)

This mode lets you take movies. Sound can be recorded at the same time.



### 1 Set the mode dial to .

The following information appears on the LCD monitor.

- 1 Flash Off icon
- 2 Movie mode icon
- 3 Card/Built-in memory
- 4 Recordable time

### 2 Press the shutter release button.

Recording starts. The flash status lamp flashes during recording.

You can change the captured area, with the digital zoom, by pressing the Zoom// button.

 : enlarges the subject.

 : enlarges the area captured by the camera.





### 3 Press the shutter release button.

Recording stops and the flash status lamp goes off.



- The flash will not discharge in Movie mode.
- Continuous shooting is not possible in Movie mode.
- The LCD monitor cannot be turned off in Movie mode.
- The focus is fixed while recording in Movie mode.
- You cannot use the optical zoom while recording in Movie mode. You should compose the picture on the LCD monitor when you use the digital zoom function.

Playing Back Movies p.92

Disabling the Digital Zoom Function p.57

#### Keeping the Shutter Release Button Pressed

Recording starts when you keep the shutter release button pressed for more than one second. The movie will be taken for as long as you keep the button pressed. Recording stops when you take your finger off the shutter release button.

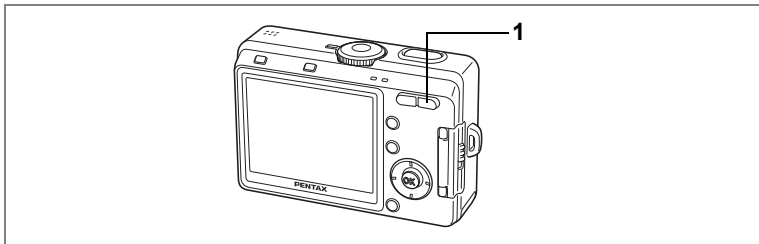

## Using the Zoom

You can use the zoom to change the shooting area.

4

Taking Pictures

### 1 Press the Zoom/▲▲▲/▲ button in Capture mode.

▲ (Tele) : enlarges the subject.

▲▲▲ (Wide) : enlarges the area captured by the camera.

The digital zoom function is turned on in initial settings. When the digital zoom function is enabled, you can combine the digital zoom with the optical zoom to give a maximum zoom magnification equivalent to eight times.

When you turn off the digital zoom in the "📷 Rec. Mode" Menu, you can only take pictures at three times magnification with the optical zoom.

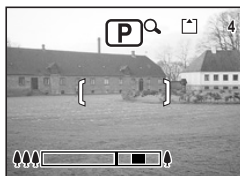

Digital zoom range

When digital zoom is enabled

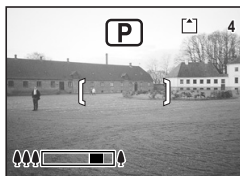

Zoom bar

When digital zoom is disabled

Saving the Zoom Position 📄 p.82



You cannot use the optical zoom in Movie mode.

## Disabling the Digital Zoom Function

### 1 Press the MENU button in Capture mode.

The [Rec. Mode] menu appears.

### 2 Use the four-way controller (▲▼) to select [Digital Zoom].

### 3 Use the four-way controller (◀▶) to select (Off).

### 4 Press the OK button.

The camera is ready to take pictures.

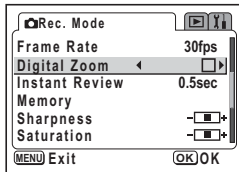

The digital zoom is disabled when you turn the LCD monitor off, even if the digital zoom function is set to On.



- You should compose the picture on the LCD monitor when you use the digital zoom function.
- The default setting for the digital zoom is  (On).

Saving the Digital Zoom Function Setting p.82

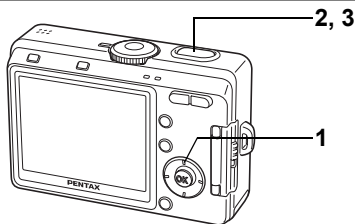

## Using the Self-Timer

- 1 Press the four-way controller (▲) in Capture mode to display ☺ or 2s on the LCD monitor.**
- 2 Press the shutter release button halfway.**  
The focus frame turns green if the subject is in focus.
- 3 Press the shutter release button fully.**

☺ The self-timer is engaged and the self-timer lamp lights for about seven seconds. The picture is taken approximately three seconds after the self-timer lamp starts to blink.

2s The self-timer is engaged and the picture is taken approximately two seconds after the self-timer lamp starts to blink.



Focusing position may shift if you move the camera while the self-timer lamp is blinking.



- The second count appears if you turn the LCD monitor on.
- To cancel the self-timer, press any button, such as the MENU button, while the second count is displayed.

Taking Pictures of Yourself p.50

Troubleshooting: "Subject is not in focus" p.135

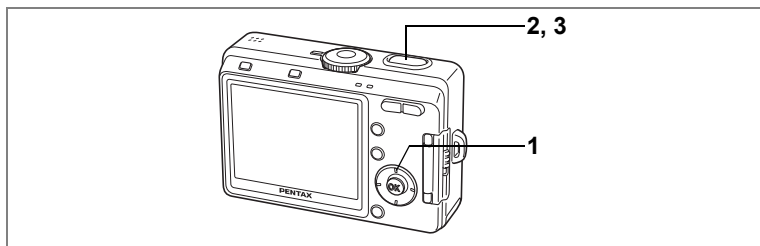

## Continuous Shooting (Continuous Shooting Mode)

Pictures are taken continuously while the shutter release button is pressed.

- 1 Press the four-way controller (▲) in Capture mode to display  on the LCD monitor.**



- 2 Press the shutter release button halfway.**

The focus frame turns green if the subject is in focus.

- 3 Press the shutter release button fully.**

Pictures are taken continuously while the shutter release button is pressed.

Shooting stops when you take your finger off the shutter release button.



- You can continue shooting until the built-in memory or the SD Memory Card is full.
- The interval will vary according to the Recorded Pixels and Quality Level settings.



- The flash will not discharge in Continuous Shooting mode.
- Continuous shooting is not possible in Movie mode, Panorama Assist or Two-in One.
- The focus, exposure and white balance are locked with the first image.

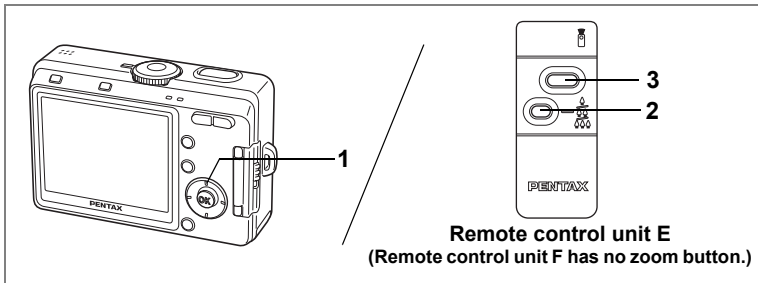

## Using the Remote Control Unit (optional)

4

Taking Pictures

You can switch the Drive mode to Remote Control mode and take pictures using the remote control unit for Pentax cameras (optional). The remote control receiver is on the front of the camera. Operate the remote control unit toward the camera lens.

- 1 Press the four-way controller (▲) in Capture mode to display  on the LCD monitor.**

The self-timer lamp blinks slowly and the camera is ready to take the picture.

- 2 Press the zoom button to adjust the zoom (for remote control unit E).**

The zoom position changes each time the zoom button is pressed in the following sequence: tele → middle → wide



- 3 Press the shutter release button on the remote control unit.**

 The picture is taken immediately.

 The self-timer lamp blinks rapidly and the picture is taken after approximately three seconds.



- Focusing position may shift if you move the camera while the self-timer lamp is blinking.
- When the Focus mode is set to Super Macro mode, the zoom magnification does not change.



- The buttons on the camera can be used in the normal way.
- Ensure that the remote control unit is no more than four meters away from the front of the camera.





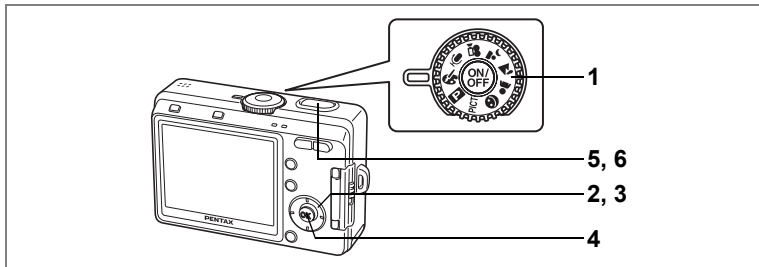

## Life of the Battery for the Remote Control Unit

A signal can be sent from the remote control unit to the camera approximately 30,000 times. Contact your nearest PENTAX customer service center if the battery needs changing. (A charge is made for changing the battery.)



## Taking Pictures with Color Filters (Digital Filter Mode)

You can take pictures with digital filters in a variety of colors, such as red, blue and green.

- 1 Set the mode dial to .**
- 2 Press the four-way controller (.**  
The screen for choosing a digital effect mode appears.
- 3 Use the four-way controller (   ) to choose a color filter.**

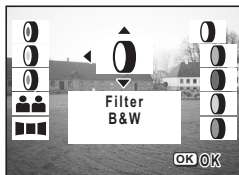



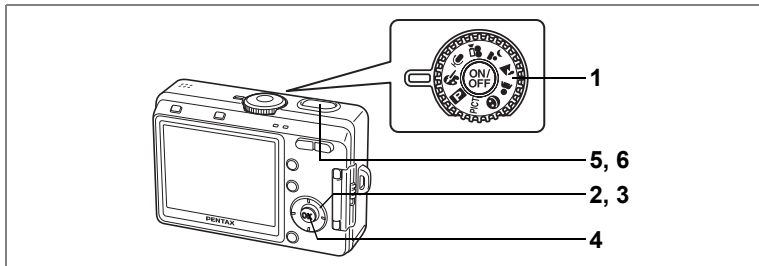





- You can choose from eight color filters: black-and-white, sepia, red, green, blue, black-and-white + red, black-and-white + green, and black-and-white + blue. You can check the filter effect on the LCD monitor when you choose a color.
- 4 Press the OK button.**
  - 5 Press the shutter release button halfway.**  
The focus frame turns green if the subject is in focus.
  - 6 Press the shutter release button fully.**  
The picture is taken.



## Taking Two-in-One Pictures (Two-in-One Mode)

You can take two images in succession and place them side by side to form a single picture. The first image is positioned in the left half of the picture and the second image in the right half.

- 1 Set the mode dial to .**
- 2 Press the four-way controller (.**  
The screen for choosing a digital effect mode appears.
- 3 Use the four-way controller (   ) to select   (Two-in-One).**
- 4 Press the OK button.**  
The screen for taking the first image appears.

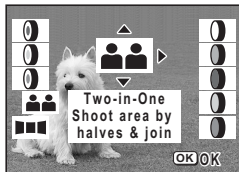

- 5 Take the first image.**  
Make sure that the subject is positioned in the left half of the screen and press the shutter release button.  
When you have taken the first image, it appears semi-transparent in the left half of the picture.



- 6 Take the second image.**  
Make sure that the subject is positioned in the right half of the screen and press the shutter release button.  
When you have taken the second image, the two images are combined to form one picture and the screen returns to Step 5.







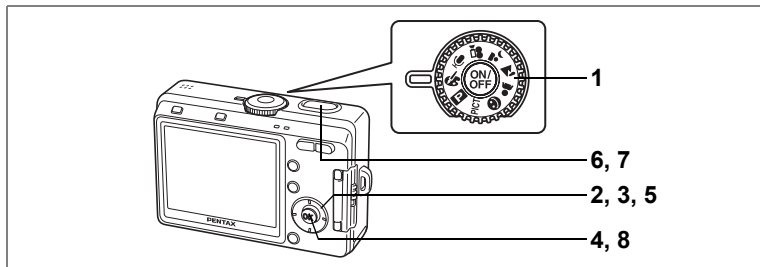

To cancel Two-in-One mode, change to another mode.







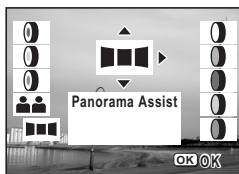

## Taking Panorama Pictures (Panorama Assist Mode)

You can take a number of images and join them together to form a panorama picture. The software (ACDSee for PENTAX) on the CD-ROM (S-SW32) provided with the camera and a computer are necessary for joining the images. The Panorama Assist mode enables you to overlap the edges of the images so that they are easier to join together into a panorama picture.

- 1** Set the mode dial to .
- 2** Press the four-way controller () .  
The screen for choosing a digital effect mode appears.
- 3** Use the four-way controller (   ) to select  (Panorama Assist).



- 4** Press the OK button.
- 5** Use the four-way controller to choose the direction in which the images will be joined.

-  Joins the images at the left.
-  Joins the images at the right.
-  Joins the images at the top.
-  Joins the images at the bottom.

The example shows the images when  is selected.



## 6 Take the first image.

Press the shutter release button to take the first image. The right edge of the image appears in semi-transparent form on the left of the LCD monitor.



## 7 Move the camera to the right and take the second image.

Move the camera until the semi-transparent image and the actual view overlap and press the shutter release button. Repeat Steps 6 and 7 to take the third and subsequent images.

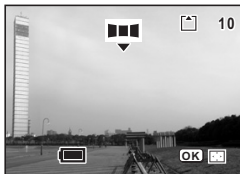

## 8 Press the OK button.

The screen returns to Step 5.



To cancel Panorama Assist mode, change to another mode.



- The camera cannot join the images. Use the ACD Photostitcher function provided in the ACDSee for PENTAX software. Refer to "Photosticher Function" (p.23) in the "ACDSee for PENTAX User Guide" for instructions on creating panorama pictures.
- Continuous shooting is not possible in Panorama Assist.

# Setting the Shooting Functions

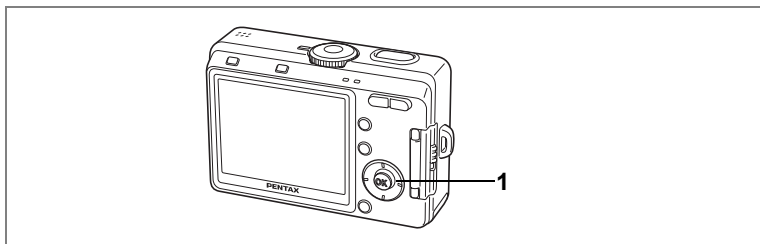

## Selecting the Focus Mode

### Focus mode

(No icon)	Autofocus mode	The camera focuses on the object in the autofocus area when the shutter release button is pressed halfway. Use this mode when the distance to the subject is more than 40 cm (16 in.).
	Macro mode	This mode is used when the distance to the subject is approx. 18 cm - 50 cm (7 in. - 20 in.). The camera focuses on the object in the autofocus area when the shutter release button is pressed halfway.
	Super Macro mode	This mode is used when the distance to the subject is approx. 6 cm - 20 cm (2.4 in. - 8 in.). The camera focuses on the object in the autofocus area when the shutter release button is pressed halfway.
	Infinity-Landscape mode	This mode is used for taking distant objects.
MF	Manual Focus mode	Adjust the focus manually with the four-way controller.

### 1 Press the four-way controller (▶) in Capture mode.

The focus mode changes each time the button is pressed and the icon appears on the LCD monitor.

The camera is ready to take pictures in the selected focus mode.



- The default setting is Autofocus mode.
- The zoom is fixed at the middle position and only the digital zoom can be used in Super Macro mode.



Be sure to check the image on the LCD monitor when the focus mode is set to Macro mode or Super Macro mode.

## Manual Focus

When the mode is set to MF (Manual Focus), the central portion of the picture is enlarged to full screen on the LCD monitor for focus adjustment. Pressing the four-way controller (▲▼) displays the indicator on the LCD monitor. Use the indicator as a guide while adjusting the focus with the four-way controller (▲▼).



For distant focus



For closer focus



Indicator

4

After the focus is set, press any button except the four-way controller (▲▼) or take your finger off the four-way controller (▲▼). The screen returns to the normal display about two seconds later.



When focusing, hold down the four-way controller (▲▼) to focus quickly.

Saving the Focus Mode p.82

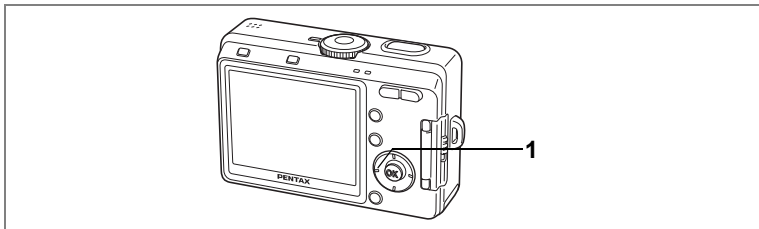

## Selecting the Flash Mode

### Flash Modes

(No icon)	Auto	The flash discharges automatically depending on the light conditions.
☹	Flash Off	The flash will not discharge, regardless of the brightness. Use this mode to take pictures at dusk or in museums etc. where flash photography is prohibited.
⚡	Flash On	The flash discharges regardless of the brightness.
⊕ A	Auto + Red-eye reduction	This mode reduces the phenomenon of red eyes caused by the light from the flash being reflected in the subject's eyes. The flash discharges automatically.
⊕ ⚡	Flash On + Red-eye reduction	This mode reduces the phenomenon of red eyes caused by the light from the flash being reflected in the subject's eyes. The flash will discharge regardless of lighting conditions.



- The flash is off when the Capture mode is set to or the Drive mode is set to Continuous Shooting or the Focus mode is set to .
- The flash discharges twice, first a pre-flash and then a second time to take the picture. (In the red-eye reduction modes, the interval between the pre-flash and the main flash is longer.)
- Flash effective range (effective range changes according to the sensitivity and shooting conditions)
  - Wide: Approximately 0.2 m to 4.9 m  
(in Night Scene Mode: Approximately 0.2 m to 3.5 m)
  - Tele: Approximately 0.2 m to 2.8 m  
(in Night Scene Mode: Approximately 0.2 m to 2 m)

### 1 Press the four-way controller (◀) in Capture mode.

The flash mode changes each time the button is pressed and the icon appears on the LCD monitor.

The camera is ready to take pictures in the selected flash mode.

Status of the Focus Status Lamp and Flash Status Lamp p.31

Saving the Flash Mode p.82

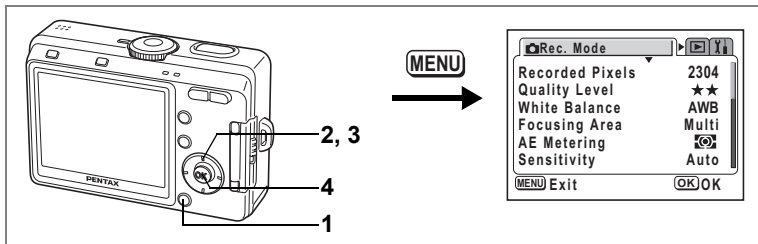

PICT

## Selecting the Recorded Pixels

You can choose the number of recorded pixels from [2304×1728], [2048×1536], [1600×1200], [1024×768] and [640×480].

The more pixels there are, the larger the picture and the bigger the file size. The data volume also varies depending on the quality level setting (☞ p.69).

### Recorded Pixels

2304×1728	Higher quality ↑	High quality photo printing, A4 size or larger prints, editing or creating images etc.	
2048×1536			
1600×1200			
1024×768			Postcard size prints
640×480			Use on the Internet/e-mail, etc.

#### 1 Press the MENU button in Capture mode.

The [📷 Rec. Mode] menu appears.

#### 2 Use the four-way controller (▲▼) to select [Recorded Pixels].

#### 3 Use the four-way controller (◀▶) to change the size.

#### 4 Press the OK button.

The camera is ready to take the picture.

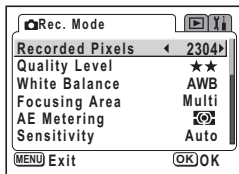

- The number of recorded pixels is fixed at [320×240] in Movie mode.
- Selecting a large size produces a clear picture when it is printed out.
- The Recorded Pixels setting is saved when the camera is turned off.

Recorded Pixels and Quality ☞ p.23

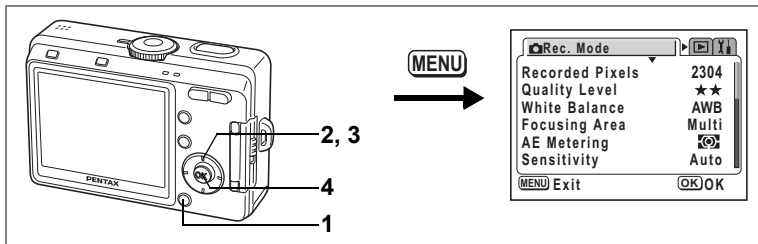

PICT [P]

## Selecting the Quality Level

You can choose the image compression rate.

The more stars, the clearer the quality and the larger the volume. The data volume also varies depending on the recorded pixels setting (see p.68).

### Quality Levels

★★★	Best	Lowest compression rate. Suitable for photo prints.
★★	Better	Standard compression rate. Suitable for viewing the image on a computer screen.
★	Good	Highest compression rate. Suitable for attaching to e-mails or creating websites.

#### 1 Press the MENU button in Capture mode.

The [Rec. Mode] menu appears.

#### 2 Use the four-way controller (▲▼) to select [Quality Level].

#### 3 Use the four-way controller (◀▶) to change the quality level.

#### 4 Press the OK button.

The camera is ready to take the picture.

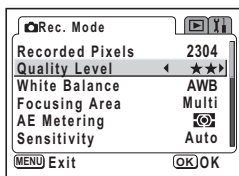

The Quality Level setting is saved when the camera is turned off.

Recorded Pixels and Quality see p.23

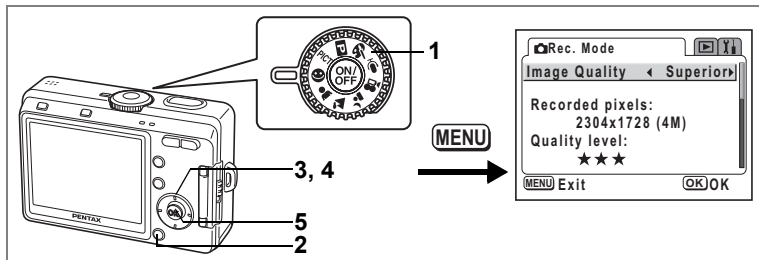

## Selecting the Image Quality

You can set the recorded pixels and quality together in Auto Select Mode. The combination of recorded pixels and quality for each setting is shown below.

### Image Quality

Setting	Recorded Pixels	Quality	Number of Pixels*	Use
Superior	2304×1728	★★★	4M	Higher quality ↑ High quality photo printing, A4 size or larger prints, editing or creating images etc.  Postcard size prints Use on the Internet/e-mail, etc.
Super	2304×1728	★★	4M	
Normal	2048×1536	★★	3M	
Economy	640×480	★★	0.3M	

\* The letter M indicates megapixel. 1 megapixel is 1 million pixels.

- 1 Set the mode dial to ☺.**
- 2 Press the MENU button in Capture mode.**  
The [📷 Rec. Mode] menu appears.
- 3 Use the four-way controller (▲▼) to select [Image Quality].**
- 4 Use the four-way controller (◀▶) to change the setting.**
- 5 Press the OK button.**  
The camera is ready to take the picture.

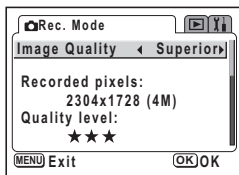

The Image Quality function is only available in ☺ (Auto Select) mode. In other modes, set the recorded pixels and quality level separately. (p.68, 69)



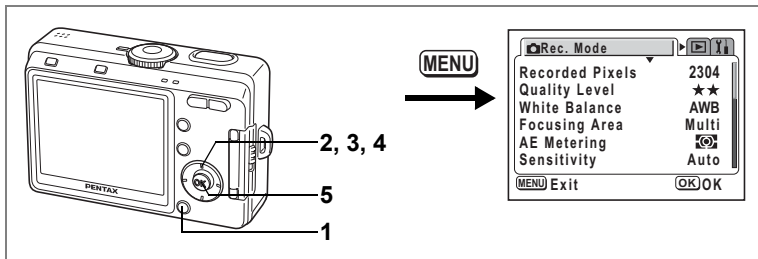

## Adjusting the White Balance

The color of the subject changes depending on the light source. For example, the white color in a subject is different when under natural or artificial light. White balance is used to adjust the color of white according to the light source.

### White Balance

<b>AWB</b>	Auto	The camera adjusts the white balance automatically.
	Daylight	Use this mode when taking pictures outside in sunlight.
	Shade	Use this mode when taking pictures outside in the shade.
	Tungsten Light	Use this mode when taking pictures under electric or other tungsten light.
	Fluorescent Light	Use this mode when taking pictures under fluorescent light.
	Manual	Use this mode when taking pictures by adjusting the white balance manually.

- 1 Press the MENU button in Capture mode.**  
The [Rec. Mode] menu appears.
- 2 Use the four-way controller (▲▼) to select [White Balance].**
- 3 Press the four-way controller (▶).**  
The White Balance screen appears.
- 4 Use the four-way controller (▲▼) to change the setting.**
- 5 Press the OK button twice.**  
The camera is ready to take the picture.

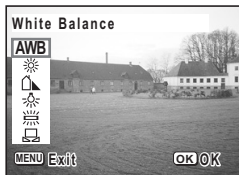

Saving the White Balance p.82

## Manual Setting

Place a white material such as a piece of white paper in front of your camera to adjust white balance.

- 1 Select [☐] (manual) on the [White Balance] screen.**
- 2 Point the camera at the white material so that it fills the frame of the LCD monitor.**
- 3 Press the OK button.**

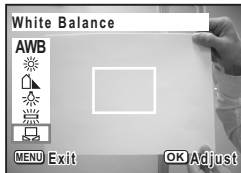



The white balance is automatically adjusted. [Adjusting] appears on the LCD monitor during adjustment.

[Complete] appears on the LCD monitor when adjustment is finished and the display returns to the menu screen.

- 4 Press the OK button.**

The camera is ready to take the picture.



Any changes made to the White Balance setting are invalid in PICT,  and  modes.

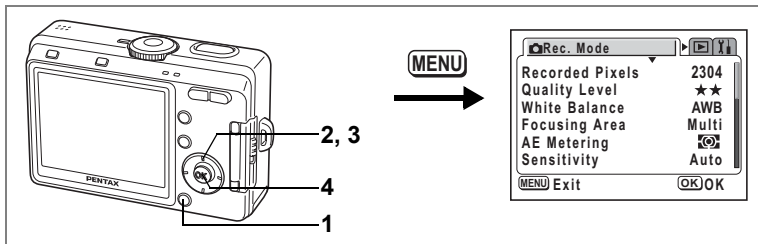

PICT

## Changing the Focusing Area

You can change the autofocus area (Focusing Area).

### Focusing Area

Multi	This is the default setting with the camera checking several points over a larger area of the image ensuring that the main subject is in focus.
Spot	The camera only focuses on a small area in the center of the screen, this is ideal for precise focusing on a specific point of the subject.

#### 1 Press the MENU button in Capture mode.

The [Rec. Mode] menu appears.

#### 2 Use the four-way controller (▲▼) to select [Focusing Area].

#### 3 Use the four-way controller (◀▶) to change the setting.

#### 4 Press the OK button.

The camera is ready to take the picture.

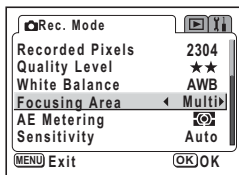

When the shutter release button is pressed while [Multi] is selected for the focusing area, the focus frame lights at the focus position.



Always check the focusing area on the LCD monitor when using the autofocus area to focus on your subject.

Saving the Focusing Area Setting p.82

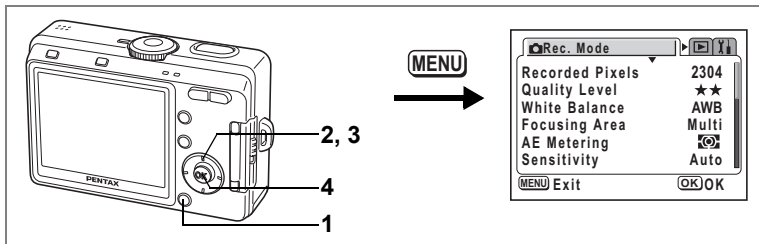

PICT P

## Setting the Light Metering Mode to Determine the Exposure (AE Metering)

4

You can choose which part of the screen to use to measure the brightness and determine the exposure.

### AE Metering Modes

	Multi-segment	The exposure is determined by the entire screen.
	Center-weighted	The exposure is determined mainly by the center of the screen.
	Spot	The exposure is determined by the small area in the center of the screen only.

#### 1 Press the MENU button in Capture mode.

The [Rec. Mode] menu appears.

#### 2 Use the four-way controller (▲▼) to select [AE Metering].

#### 3 Use the four-way controller (◀▶) to change the AE Metering mode.

#### 4 Press the OK button.

The camera is ready to take the picture.

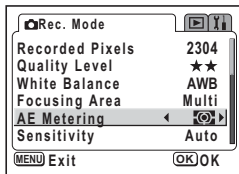

Saving the AE Metering Mode p.82

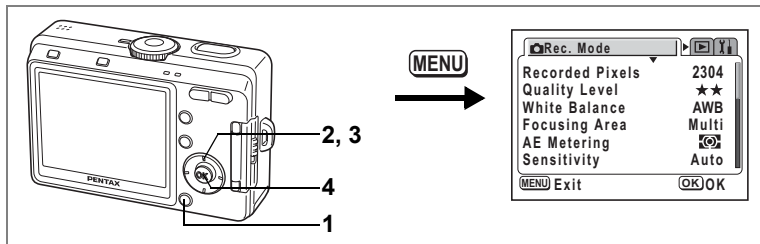

PICT

## Setting the Sensitivity

You can select the sensitivity to suit the brightness of the surroundings.

### Sensitivity

Auto	Automatically set in a range from 50 to 400 (50 to 200 in Night Scene Mode).
50	<ul style="list-style-type: none"> <li>The lower the sensitivity, the sharper the image and the less noise. The shutter speed will be slower in low light conditions.</li> <li>The higher the sensitivity, the faster the shutter speed in low light conditions to reduce camera shake, but the image may be affected by noise.</li> </ul>
100	
200	
400	

#### 1 Press the MENU button in Capture mode.

The [Rec. Mode] menu appears.

#### 2 Use the four-way controller (▲▼) to select [Sensitivity].

#### 3 Use the four-way controller (◀▶) to change the sensitivity.

#### 4 Press the OK button.

The camera is ready to take the picture.

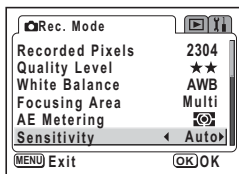

Saving the Sensitivity p.82

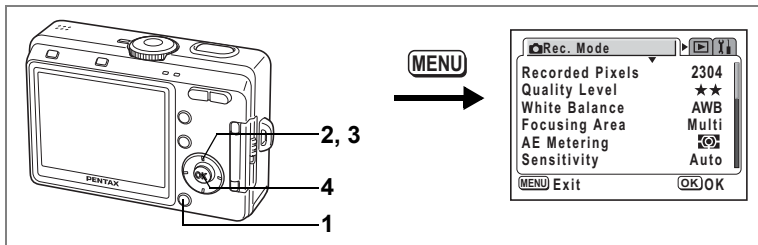

## Setting the Frame Rate

You can choose 30 fps (frames per second) or 15 fps for the frame rate.

4

Taking Pictures

### 1 Press the MENU button in Capture mode.

The [Rec. Mode] menu appears.

### 2 Use the four-way controller (▲▼) to select [Frame Rate].

### 3 Use the four-way controller (◀▶) to change the frame rate.

### 4 Press the OK button.

The camera is ready to take the picture.

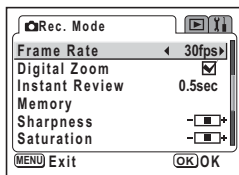

The Frame Rate setting is saved when the camera is turned off.

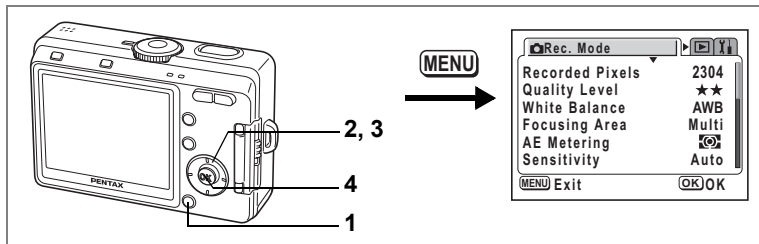

PICT

## Setting the Instant Review Time (Instant Review)

You can choose the Instant Review time from 0.5 sec., 1 sec., 2 sec., 3 sec., 5 sec. and Off (no display).

### 1 Press the MENU button in Capture mode.

The [Rec. Mode] menu appears.

### 2 Use the four-way controller (▲▼) to select [Instant Review].

### 3 Use the four-way controller (◀▶) to change the display time.

### 4 Press the OK button.

The camera is ready to take the picture.

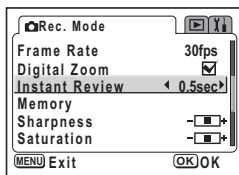

The Instant Review setting is saved when the camera is turned off.

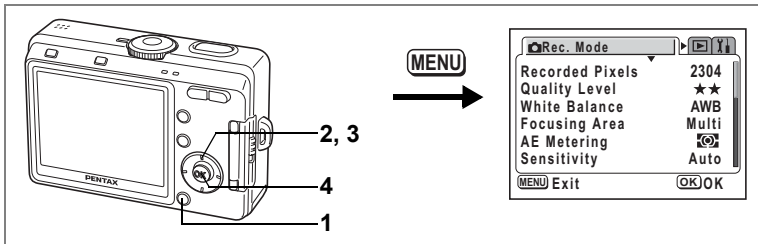

## Setting the Image Sharpness (Sharpness)

You can choose whether you want the image to have sharp or soft outlines.

4

Taking Pictures

### 1 Press the MENU button in Capture mode.

The [Rec. Mode] menu appears.

### 2 Use the four-way controller (▲▼) to select [Sharpness].

### 3 Use the four-way controller (◀▶) to change the setting from

[Normal] to  [Hard (+)] or  [Soft (-)].

### 4 Press the OK button.

The camera is ready to take the picture.

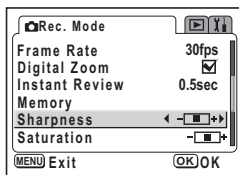

- Any changes made to the Sharpness setting are invalid in PICT, and modes.
- The Sharpness setting is saved when the camera is turned off.



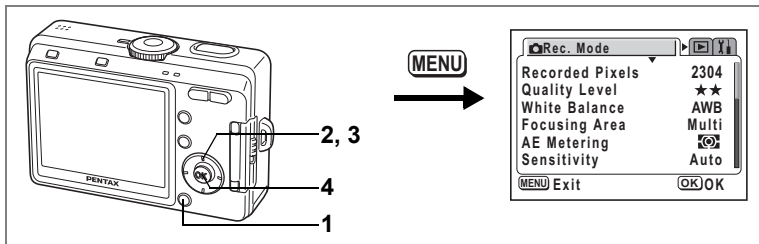

## Setting the Color Saturation (Saturation)

You can set the color saturation.

### 1 Press the MENU button in Capture mode.

The [Rec. Mode] menu appears.

### 2 Use the four-way controller (▲▼) to select [Saturation].

### 3 Use the four-way controller (◀▶) to change the setting from [Normal] to [High (+)] or [Low (-)].

### 4 Press the OK button.

The camera is ready to take the picture.

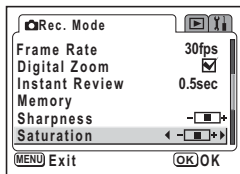

- Any changes made to the Saturation setting are invalid in PICT, ▲ and 👤 modes.
- The Saturation setting is saved when the camera is turned off.

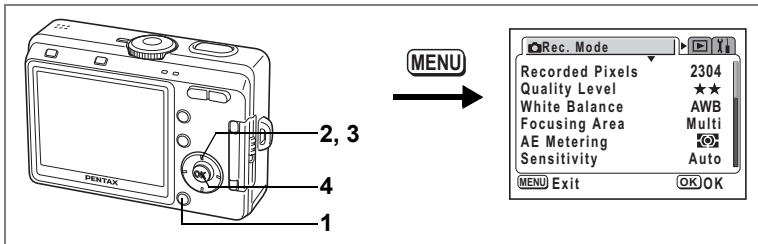

## Setting the Image Contrast (Contrast)

You can set the image contrast.

### 1 Press the MENU button in Capture mode.

The [Rec. Mode] menu appears.

### 2 Use the four-way controller (▲▼) to select [Contrast].

### 3 Use the four-way controller (◀▶) to change the setting from [Normal] to [High (+)] or [Low (-)].

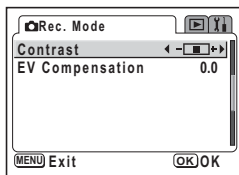

### 4 Press the OK button.

The camera is ready to take the picture.



- Any changes made to the Contrast setting are invalid in PICT, ▲ and 👤 modes.
- The Contrast setting is saved when the camera is turned off.

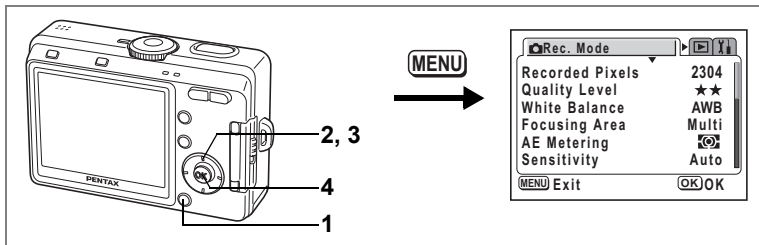

PICT P

## Setting the Exposure (EV Compensation)

You can adjust the overall brightness of the picture.

Use this function to take pictures that are intentionally overexposed or underexposed.

### 1 Press the MENU button in Capture mode.

The [📷 Rec. Mode] menu appears.

### 2 Use the four-way controller (▲▼) to select [EV Compensation].

### 3 Use the four-way controller (◀▶) to change the EV setting.

To brighten, set a positive (+) value. To darken, set a negative (–) value.

You can choose the EV setting in the range of –2.0 EV to +2.0 EV in 1/3 EV steps.

### 4 Press the OK button.

The camera is ready to take the picture.

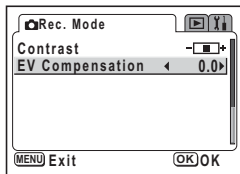









EV Compensation is registered on the four-way controller (◀▶) in the Fn Setting default settings in Capture mode. (p.128) The EV setting can be changed with the four-way controller (◀▶) when you press the **Fn/Fn** button.

Saving the EV Compensation Value p.82

# Saving the Settings

## Saving the Menu Items (Memory)

You can choose whether you want the set values to be saved when the camera is turned off. If you select  (On), the settings will be saved in the status they were in immediately before the camera was turned off. If you select  (Off), the settings will be reset to the defaults when the camera is turned off.

Item	Description	Default Setting
Flash	The flash mode setting on the  button is saved.	<input checked="" type="checkbox"/>
White Balance	The [White Balance] setting on the [  Rec. Mode] menu is saved.	<input type="checkbox"/>
EV Compensation	The [EV Compensation] setting on the [  Rec. Mode] menu is saved.	<input type="checkbox"/>
Focusing Area	The [Focusing Area] setting on the [  Rec. Mode] menu is saved.	<input type="checkbox"/>
AE Metering	The [AE Metering] setting on the [  Rec. Mode] menu is saved.	<input type="checkbox"/>
Sensitivity	The [Sensitivity] setting on the [  Rec. Mode] menu is saved.	<input type="checkbox"/>
Digital Zoom	The [Digital Zoom] setting on the [  Rec. Mode] menu is saved.	<input checked="" type="checkbox"/>
Focus Mode	The focus mode setting on the  button is saved.	<input type="checkbox"/>
Zoom Position	The optical zoom position on the Zoom button is saved.	<input type="checkbox"/>
MF	The manual focus position is saved.	<input type="checkbox"/>
DISPLAY	The LCD monitor display mode is saved.	<input type="checkbox"/>
File #	The file number is saved. If a new SD Memory Card is inserted, file numbers are assigned sequentially.	<input checked="" type="checkbox"/>



- Menu items not included in [Memory] will also be saved in the settings selected on the menus for each function when the camera is turned off.
- The zoom position setting in the digital zoom range will not be saved even if [Zoom Position] is set to  (On) in [Memory].
- Setting [MF] to  (On) sets [Zoom Position] to  (On) at the same time. ([Zoom Position] can also be set to  (On) independently of [MF].)

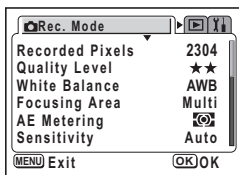
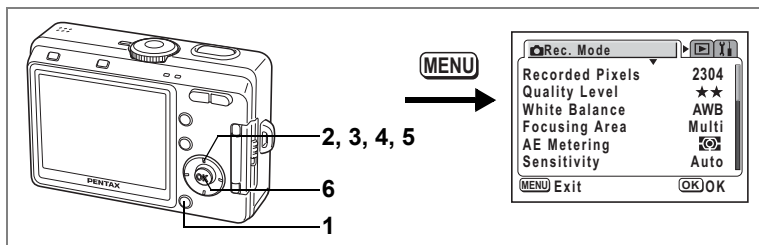

**1 Press the MENU button in Capture mode.**

The [Rec. Mode] menu appears.

**2 Use the four-way controller (▲▼) to select [Memory].**

**3 Press the four-way controller (▶).**

The [Memory] menu appears.

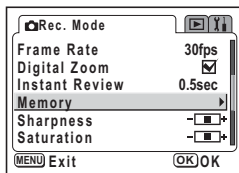

**4 Use the four-way controller (▲▼) to choose an item.**

**5 Use the four-way controller (◀▶) to select  (On) or  (Off).**

**6 Press the OK button twice.**

The camera is ready to take the picture.

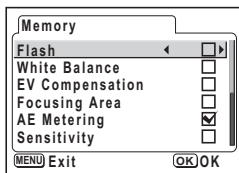

## Recording Sound (Voice Recording Mode)

You can record sound. The recordable time appears on the LCD monitor according to how much space is available on the SD Memory Card or the built-in memory.

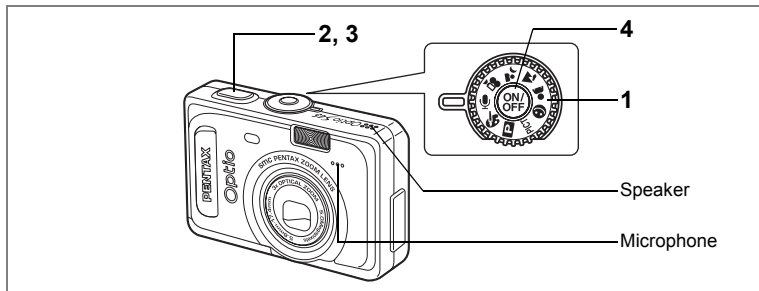

5

### 1 Set the mode dial to and press the power switch.

The recordable time appears on the LCD monitor.

1 Remaining recordable time

2 Recording time

### 2 Press the shutter release button.

Recording starts. The self-timer lamp and flash status lamp blink during recording.

### 3 Press the shutter release button.

Recording stops. The remaining recordable time appears.

### 4 To exit Voice Recording mode, turn the camera off.

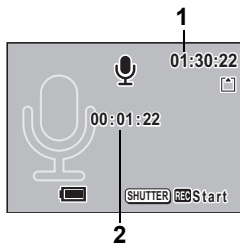





- Sound is saved in WAVE monaural files.
- The microphone is located on the front of the camera. Aim the camera to obtain the best sound.

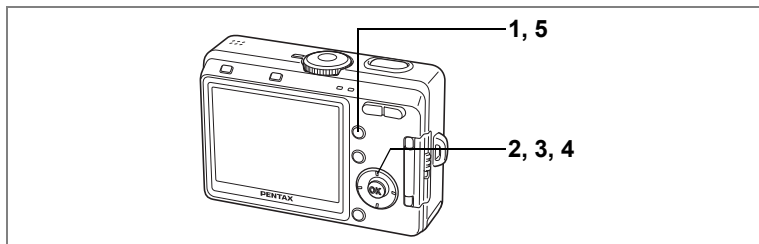





# Playing Back Sound

You can play back the recording you made in Voice Recording mode.



- 1 Press the  Playback button.**
- 2 Use the four-way controller ( ) to choose the recording to play back.**
- 3 Press the four-way controller (). Playback starts.**

• **The following operations can be performed during playback.**

- Four-way controller ( ) Pauses playback
- Zoom//Q button () Increases the volume
- Zoom//Q button () Reduces the volume

- 4 Press the four-way controller (). Playback stops.**

- 5 Press the  Playback button.**  
The camera returns to the Voice Recording mode.

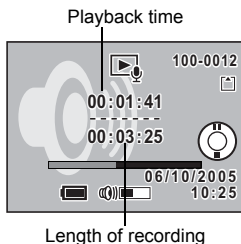

If you enter the Playback mode from a Capture mode other than Voice Recording mode, the camera returns to the Capture mode in Step 5. To record new data, set the Mode Dial to .

# Adding Sound (Voice Memo) to Images

You can add sound (voice memo) to a captured image.

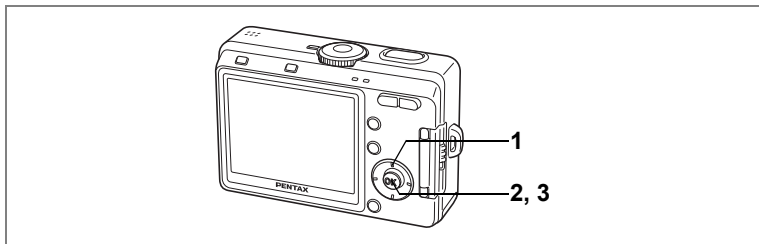

## Recording a Voice Memo

- 1 Enter the Playback mode and use the four-way controller (◀▶) to choose the image to which you want to add a voice memo.**

🎤 appears on the four-way controller operation guide on the LCD monitor if there is no voice memo attached to the displayed image.

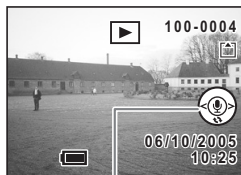

Four-way controller operation guide

- 2 Press the OK button.**

Recording of the voice memo starts. You can record for up to 30 seconds.

- 3 Press the OK button.**

Recording of the voice memo stops.



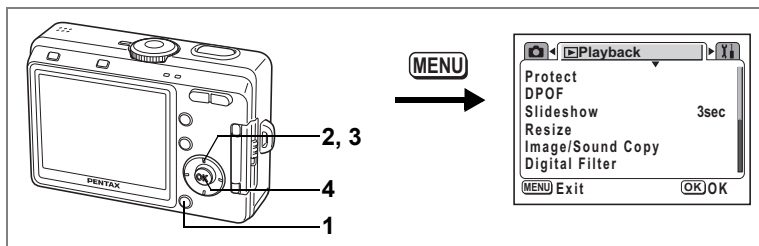

## Setting the Voice Memo Recording Function

You can set the camera not to record voice memos while playing back still images to prevent any voice memo from being recorded.

- 1 Press the MENU button in Playback mode.**  
The [▶ Playback] menu appears.
- 2 Use the four-way controller (▲▼) to select [Record Voice Memo].**
- 3 Use the four-way controller (◀▶) to select [On] or [Off].**  
On : Voice memos can be recorded while playing back still images.  
(Default setting)  
Off : Voice memos cannot be recorded while playing back still images.
- 4 Press the OK button.**  
The camera is ready to take or play back images.



When voice memo recording is set to off,  is not displayed while playing back still images.

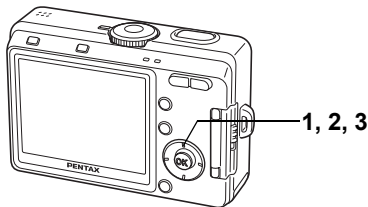

## Playing Back a Voice Memo

- 1 Enter the Playback mode and use the four-way controller (◀▶) to choose the image with the voice memo that you want to play back.**

If [J] appears, a voice memo has been recorded for the displayed image.



- 2 Press the four-way controller (▲).**

The voice memo is played back.

- 3 Press the four-way controller (▼).**

Playback of the voice memo stops.

Deleting a Voice Memo  p.97



A voice memo cannot be added to an image which already has a voice memo. Delete the old voice memo and record a new one. ( p.97)



A voice memo cannot be added to protected ( -) images.

**Memo**

# Playing Back Images

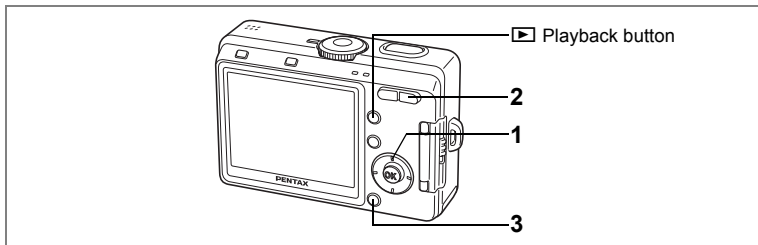

## Playing Back Still Pictures

Press the Playback button.

Refer to “Playing Back Images” (p.32) for instructions.

## Zoom Display

You can display images magnified up to 12 times. A guide to operation appears on the LCD monitor during magnification.

- 1 Enter the Playback mode and use the four-way controller (◀▶) to choose the image to magnify.**
- 2 Press on the Zoom//Q button.**

The image is magnified (1× to 12×). Holding down the button changes the magnification continuously.

**The following operations can be performed while the magnified image is displayed.**

- |                            |                                    |
|----------------------------|------------------------------------|
| Four-way controller (▲▼◀▶) | Moves the position to be magnified |
| Zoom//Q button (▲)         | Makes the image bigger             |
| Zoom//Q button (◆◆◆)       | Makes the image smaller            |

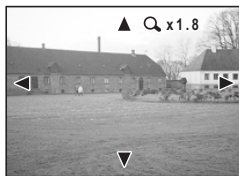

- 3 Press the MENU button.**

Zoom playback ends.

**Caution**

- Movies cannot be magnified.
- Pressing the Playback button does not change the mode to the Capture mode when the camera is turned on in Playback Only mode. Turn the camera off, then turn it on again.

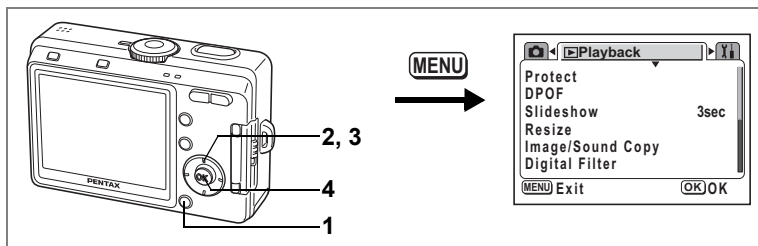

## Setting the Quick Zoom Function

You can display the image at maximum magnification simply by pressing the Zoom//Q button once during zoom playback.

- 1 Press the MENU button in Playback mode.**  
The [ Playback] menu appears.
- 2 Use the four-way controller ( ) to select [Quick Zoom].**
- 3 Use the four-way controller ( ) to select [On] or [Off].**  
On : Pressing /Q on the Zoom//Q button once displays the image at maximum magnification.  
Off : Pressing /Q on the Zoom//Q button once magnifies the image in steps.
- 4 Press the OK button.**  
The camera is ready to take or play back images.

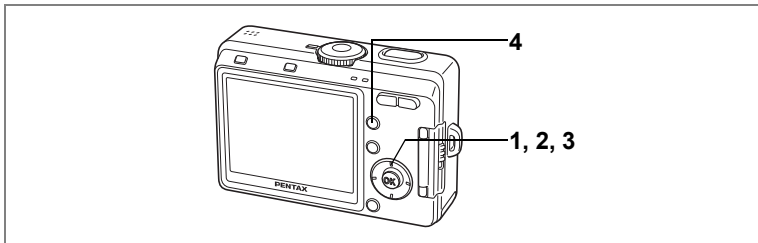

## Playing Back Movies

You can play back movies. A guide to operation appears on the LCD monitor during playback. Sound is recorded at the same time.

**1 Enter the Playback mode and use the four-way controller (◀▶) to choose the movie to play back.**

**2 Press the four-way controller (▲).**

Playback starts.

- **The following operations can be performed during playback.**

- Four-way controller (◀) Reverse playback
- Four-way controller (▶) Forward playback
- Four-way controller (▲) Pause
- Zoom button ▲▲▲/▲ Adjusts the volume

- **The following operations can be performed while Pause is engaged.**

- Four-way controller (◀) Frame reverse
- Four-way controller (▶) Frame forward
- Four-way controller (▲) Releases the Pause function

**3 Press the four-way controller (▼).**

Playback stops and the screen returns to the start playback screen.

**4 Press the ▶ Playback button.**

The camera returns to Capture mode.

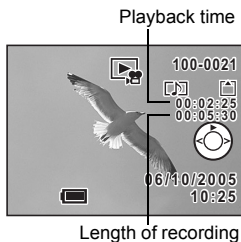

## Displaying Shooting Information in Playback Mode

Shooting information can be displayed on the LCD monitor in Playback mode. Pressing the DISPLAY button changes the display mode.

### Normal Display

Shooting information is displayed.

- 1 Protect icon
- 2 Voice Memo icon
- 3 Folder name and file name
- 4 Card/Built-in memory icon
- 5 Four-way controller operation guide
- 6 Shooting date and time
- 7 Battery level indicator

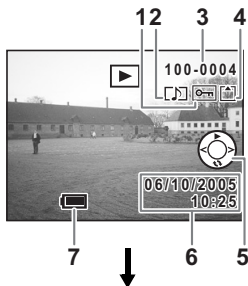

### Histogram Display

The brightness distribution of the image is displayed. The horizontal axis of the histogram shows the brightness (darkest at the left end and brightest at the right end) and the vertical axis shows the number of pixels.

- 1 Sensitivity
- 2 Recorded pixels
- 3 Quality
- 4 White balance
- 5 Histogram
- 6 Shutter speed
- 7 Aperture
- 8 AE metering

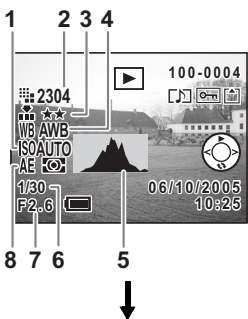

### No Icons

No shooting information is displayed.



Normal Display

Saving the Display Mode p.82

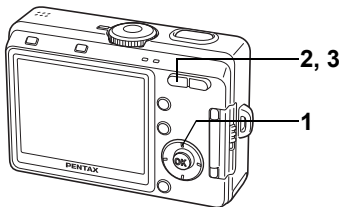

## Nine Image Display

You can display nine images at the same time.

- 1 Enter the Playback mode and use the four-way controller (◀▶) to choose an image.**
- 2 Press ▲▲▲/☒ on the Zoom/☒/Q button.**

Nine images appear.

Use the four-way controller (▲▼◀▶) to choose an image. When ten or more images have been recorded, the previous nine images appear when you press the four-way controller (◀) while image ① is selected. Similarly, the next nine images appear when you press the four-way controller (▶) while image ② is selected.

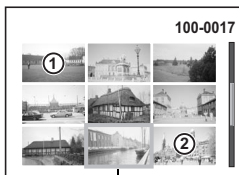

Selected image

- 3 Press ▲▲▲/☒ or ▲/Q on the Zoom/☒/Q button.**

The screen returns to full screen display of the selected image. Pressing ▶ button, ☒/Fn button, OK button or DISPLAY button returns the screen to full screen display of the selected image.



Pressing the ☒ Delete button while selecting an image opens the Delete screen.



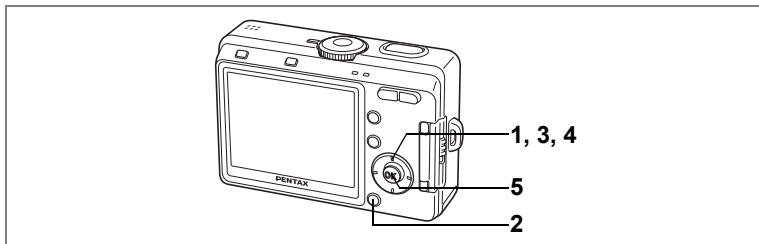

## Slideshow

You can play back all the images on the SD Memory Card or in the built-in memory continuously.

- 1 Enter the Playback mode and use the four-way controller (◀▶) to choose the image with which to start the slideshow.**
- 2 Press the MENU button.**
- 3 Use the four-way controller (▲▼) to select [Slideshow].**
- 4 Use the four-way controller (◀▶) to change the playback interval.**

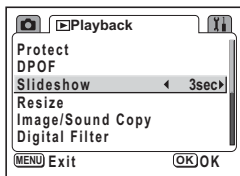

Choose from the following: 3 sec, 5 sec, 10 sec, 20 sec, 30 sec.

- 5 Press the OK button.**

[Start] appears on the LCD monitor and playback starts at the set interval.

Press any button, such as the OK button or MENU button, to stop the slideshow. [Stop] appears on the LCD monitor.



- The slideshow will continue until you press any button.
- Movies and pictures with a voice memo will be played through to the end before the next picture is played back, regardless of the set playback interval.
- Recordings made in Voice Recording mode are not played back.

# Deleting

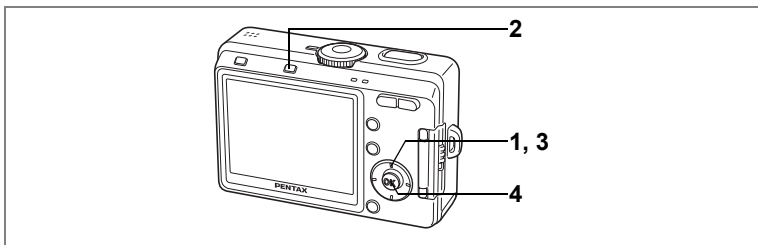

## Deleting Individual Images or Sounds

You can delete images and sound recordings one at a time.



- Once deleted, images cannot be restored.
- You cannot display the Delete screen from protected images. (☞ p.99)

**1 Enter the Playback mode and use the four-way controller (◀▶) to choose the image or sound to delete.**

**2 Press the  Delete button.**

The Delete screen appears.

**3 Use the four-way controller (▲) to select [Delete].**

**4 Press the OK button.**

The image and sound are deleted.



- You can also delete images from Instant Review (☞ p.77). However, you cannot delete images if the display time is set to 0.5 seconds.
- You can also delete images from the nine image display (☞ p.94). However, you cannot delete protected images. (☞ p.99)
- If [Quick Delete] is set to [On] in the [▶ Playback] menu, Step 3 can be omitted. (☞ p.97)

## Deleting a Voice Memo only

If an image has a voice memo, you can delete the voice memo without deleting the image.

- 1 Enter the Playback mode and use the four-way controller (◀▶) to choose an image with a voice memo to delete.**
- 2 Press the  Delete button.**  
The Delete screen appears.
- 3 Use the four-way controller (▲) to select [Sound Deletion].**
- 4 Press the OK button.**  
The voice memo is deleted.



Select [Delete] in Step 3 above to delete both the image and the voice memo.

## Setting the Quick Delete Function

When the Quick Delete function is set to On, the Delete screen appears with [Delete] already selected.

- 1 Press the MENU button in Playback mode.**  
The [ Playback] menu appears.
- 2 Use the four-way controller (▲▼) to select [Quick Delete].**
- 3 Use the four-way controller (◀▶) to select [On] or [Off].**
- 4 Press the OK button.**  
The camera is ready to take or play back images.

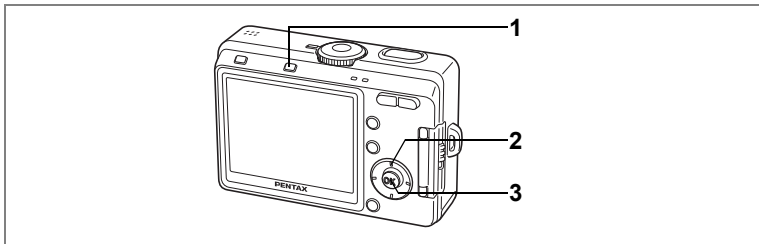



## Deleting All Images

You can delete all the images and sounds at once.



- Once deleted, images cannot be restored.
- Protected images and sounds cannot be deleted.

- 1 Press the  Delete button twice in Playback mode.**  
The Delete All screen appears.
- 2 Use the four-way controller () to select [Delete All].**
- 3 Press the OK button.**  
All the images and sounds are deleted.



You can also delete images from Instant Review ( p.77).

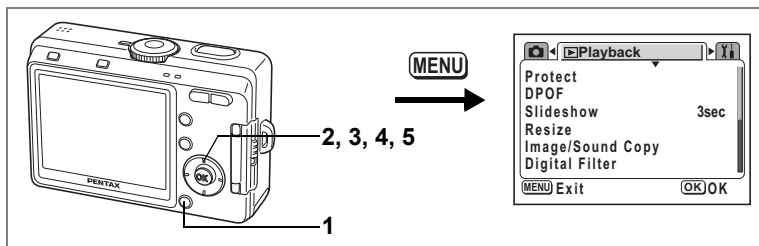

## Protecting Images and Sounds from Deletion (Protect)

You can protect images and sounds from being accidentally deleted.

- 1 Press the MENU button in Playback mode.**  
The [▶ Playback] menu appears.
- 2 Use the four-way controller (▲▼) to select [Protect].**
- 3 Press the four-way controller (▶).**  
The Protect screen appears.
- 4 Use the four-way controller (◀▶) to choose the image or sound to protect.**
- 5 Use the four-way controller (▲▼) to select [Protect].**  
 appears on the image or sound. Select [Unprotect] to cancel the Protect setting.

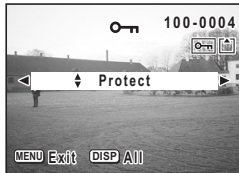
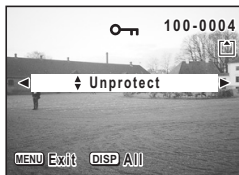

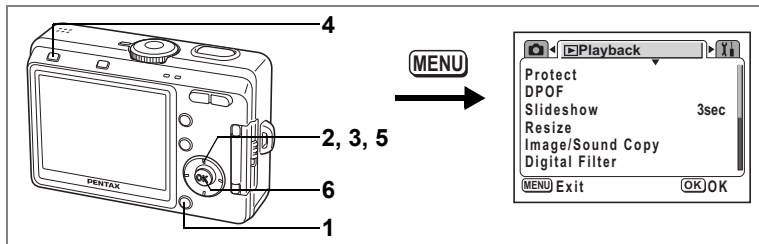

## Protecting All Images and Sounds

You can protect all the images and sounds.

- 1 Press the MENU button in Playback mode.**  
The [▶ Playback] menu appears.
- 2 Use the four-way controller (▲▼) to select [Protect].**
- 3 Press the four-way controller (▶).**  
The Protect screen appears.
- 4 Press the DISPLAY button.**  
The Protect All screen appears.
- 5 Use the four-way controller (▲) to select [Protect].**
- 6 Press the OK button.**

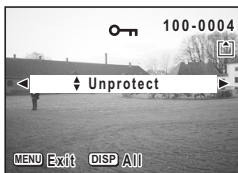

Select [Unprotect] in Step 5 to cancel the Protect setting on all the images and sounds.



Even protected images and sounds will be deleted by formatting the SD Memory Card or the built-in memory.

# Viewing Images on a TV

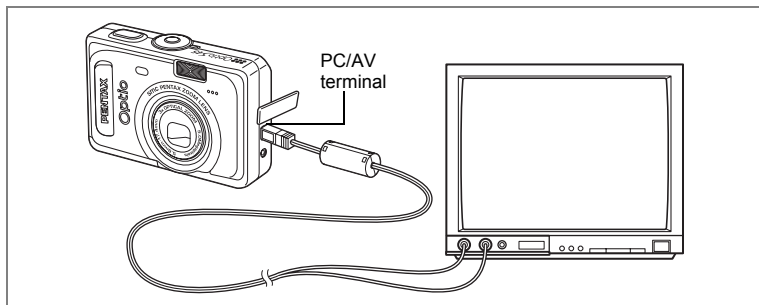

By using the AV cable, you can capture and play back images on a TV or other equipment with a video IN jack. Make sure that both the TV and the camera are turned off before connecting the cable.

**1** Open the terminal cover and connect the AV cable to the PC/AV terminal.

**2** Connect the other end of the AV cable to the image input terminal and sound input terminal on the TV.

When using stereo sound equipment, insert the sound terminal into the L (white) terminal.

**3** Turn the TV and camera on.

Changing the Video Output Format Ⓜp.125



If you intend to use the camera for a long time, use of the AC adapter D-AC5 (optional) is recommended. Refer to the operating manual for the TV or equipment to which the camera is connected.

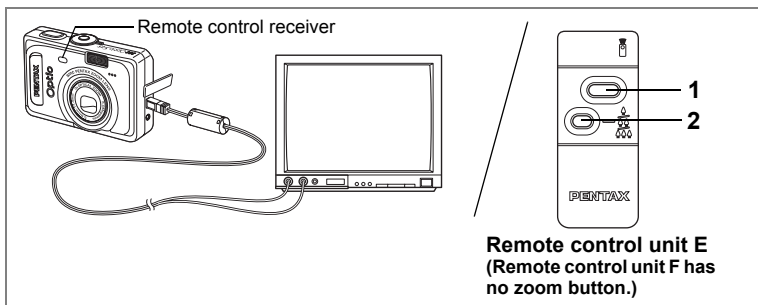

## Using the Remote Control Unit (optional) to View the Previous or the Next Image

You can use the remote control unit to view the next image or the previous image while watching the images on a TV.

### 1 Press the shutter release button on the remote control unit.

The image following the current image is played.

### 2 Press the remote zoom button on the remote control unit.

The image preceding the current image is played.



- Using the remote control unit to view the next or previous image is only enabled when the AV cable is connected.
- You can only use the remote control unit to view the next or previous image when playing back still images in the 1 image screen (normal). You cannot use the remote control unit to start or stop movies, still images with sound or sound only files, so use the buttons on the camera. Also, the remote control unit cannot be used at all while movies, still images with sound or sound only files are being played back or are paused.
- You need the remote control unit E (optional) to view the next or previous image.
- You can only view the next image with the remote control unit F (optional).



# Setting the Printing Service (DPOF)

You can print the images on the SD Memory Card or the built-in memory using a DPOF (Digital Print Order Format) compatible printer or at a printing service.

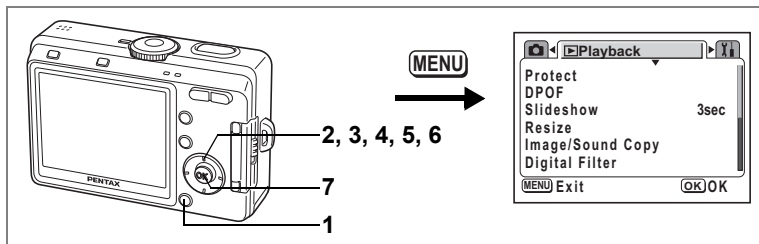

## Printing Single Images

Set the following items for each image.

**Copies:** Choose the number of copies up to a maximum of 99.

**Date:** Specify whether you want the date inserted on the print or not.

To set the items for images stored in the built-in memory, check that there is no SD Memory Card inserted in the camera.

- 1 Press the MENU button in Playback mode.**  
The [▶ Playback] menu appears.
- 2 Use the four-way controller (▲▼) to select [DPOF].**
- 3 Press the four-way controller (▶).**  
The DPOF screen appears.
- 4 Use the four-way controller (◀▶) to choose an image to print, then press the four-way controller (▼).**  
The frame moves to [Copies].

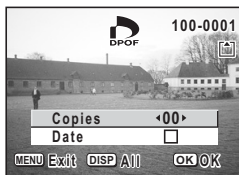

**5 Use the four-way controller (◀▶) to choose the number of copies, then press the four-way controller (▼).**

The frame moves to [Date].



**6 Use the four-way controller (◀▶) to choose whether to insert the date or not.**

- (On) : The date will be imprinted.
- (Off) : The date will not be imprinted.

**7 Press the OK button.**

Prints can be made according to the settings.



- If DPOF settings have already been made for an image, the previous number of copies and date setting will be displayed.
- To cancel DPOF settings, set the number of copies to 0 and press the OK button.
- To print images stored in the built-in memory according to DPOF settings at a photo processing lab., follow the procedure in “Copying Files” (p.114 - 115) and copy the files from the built-in memory to the SD Memory Card first.



- You cannot set the printing service for movies or sound-only files.
- Depending on the printer or printing equipment at the photo processing lab., the date may not be imprinted on the pictures even if the DPOF setting was made.
- Pictures may not be printed correctly when the camera is connected directly to a PictBridge-compatible printer if the total number of copies exceeds 500.

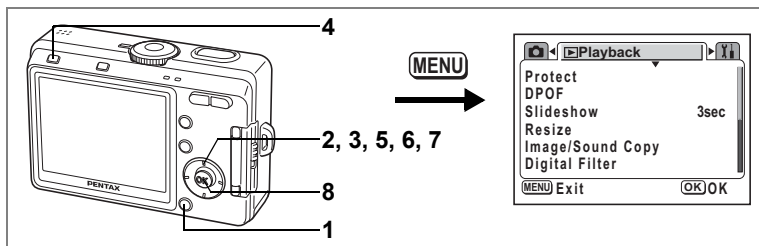

## Printing All Images

- 1 Press the MENU button in Playback mode.**  
The [▶ Playback] menu appears.
- 2 Use the four-way controller (▲ ▼) to select [DPOF].**
- 3 Press the four-way controller (▶).**  
The DPOF screen appears.
- 4 Press the DISPLAY button.**
- 5 Use the four-way controller (◀ ▶) to choose the number of copies.**  
You can print up to 99 copies.
- 6 Press the four-way controller (▼).**  
The frame moves to [Date].
- 7 Use the four-way controller (◀ ▶) to choose whether to insert the date or not.**  
 (On) : The date will be imprinted.  
 (Off) : The date will not be imprinted.
- 8 Press the OK button.**  
Prints can be made according to the settings.



- The number of copies specified in the DPOF settings applies to all the images. Before printing, check that the number is correct.
- Pictures may not be printed correctly when the camera is connected directly to a PictBridge-compatible printer if the total number of copies exceeds 500.



- Settings for single images are cancelled when settings are made for all images.
- DPOF settings are not possible for movies or sound only files.

# Direct Printing Using PictBridge

By connecting the camera to a printer that supports PictBridge using the USB cable (I-USB7) supplied with the camera, you can print images directly from the camera without using a PC. Select the images you want to print and the number of copies on the camera after it has been connected to the printer.



- You are recommended to use the AC adapter D-AC5 (optional) while the camera is connected to the printer. The printer may not work properly or the image data may be damaged if the batteries run out of power while the camera is connected to the printer.
- The flash status lamp blinks slowly while data is being transferred from the camera to the printer.
- Do not disconnect the USB cable during data transfer.
- Depending on the type of printer, not all the settings made on the camera (such as image quality and DPOF settings) may be valid.
- Pictures may not be printed correctly when the camera is connected directly to a PictBridge-compatible printer if the total number of copies exceeds 500.

6



The camera will turn off automatically when you remove the USB cable.

## Connecting the Camera to the Printer

### 1 Select [PictBridge] for [USB Connection] on the [X] Set-up] menu.

☞ “Changing the USB Connection Mode” (p.126)

### 2 Connect the camera to the printer using the USB cable supplied with the camera.

The PictBridge menu appears.

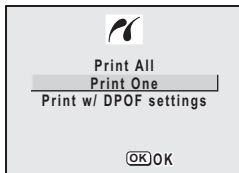

Do not connect the camera to your PC while [PictBridge] is selected for the USB connection mode.

See Step 4 in the “PC Connection Manual” if the camera has been connected to a PC while “PictBridge” is set.

## Printing Single Images

- 1 Use the four-way controller (▲▼) to select [Print One].**

- 2 Press the OK button.**

The Print One screen appears.

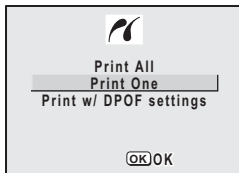

- 3 Use the four-way controller (◀▶) to choose the image to print.**

- 4 Use the four-way controller (▲▼) to choose the number of copies.**

You can print up to 99 copies.



- 5 Use the DISPLAY button to choose whether to insert the date or not.**

- (On) : The date will be imprinted.
- (Off) : The date will not be imprinted.

- 6 Press the OK button.**

Prints will be made according to the settings.

To cancel printing during operation, press the MENU button.

## Printing All Images

**1 Use the four-way controller (▲▼) to select [Print All].**

**2 Press the OK button.**

The Print All screen appears.

**3 Use the four-way controller (▲▼) to choose the number of copies.**

The number of copies you choose applies to all the images.

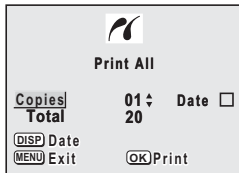

**4 Use the DISPLAY button to choose whether to insert the date or not.**

(On) : The date will be imprinted.

(Off) : The date will not be imprinted.

**5 Press the OK button.**

All the images will be printed according to the settings.

To cancel printing during operation, press the MENU button.

6

## Printing Using the DPOF Settings

**1 Use the four-way controller (▲▼) to select [Print w/ DPOF settings].**

**2 Press the OK button.**

The Print w/ DPOF Settings screen appears.

Use the four-way controller (◀▶) to check the image and the print settings.

**3 Press the OK button.**

The selected image will be printed according to the DPOF settings.

To cancel printing during operation, press the MENU button.



## Disconnecting the Camera from the Printer

Disconnect the camera from the printer when you have finished printing.

- 1 Turn the camera off.**
- 2 Disconnect the USB cable from the camera.**
- 3 Disconnect the USB cable from the printer.**

# Editing Images

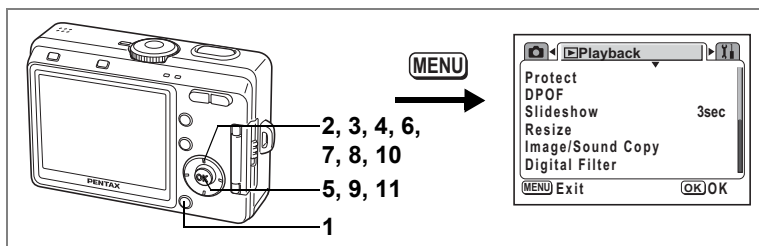

## Changing the Image Size and Quality

By changing the size and quality of a selected image, you can make the file smaller than the original. You can use this function to continue taking pictures when the SD Memory Card or the built-in memory is full, by making the images smaller and overwriting the original images to make more space available in the memory.

- 1 Press the MENU button in Playback mode.**

The [▶ Playback] menu appears.

- 2 Use the four-way controller (▲▼) to select [Resize].**

- 3 Press the four-way controller (▶).**

The Resize screen appears.



- 4 Use the four-way controller (◀▶) to choose the image to resize.**

- 5 Press the OK button.**

The screen for selecting the resolution and quality appears.



- 6 Use the four-way controller (◀▶) to change the recorded pixels.**
- 7 Press the four-way controller (▼).**  
The frame moves to [Quality Level].
- 8 Use the four-way controller (◀▶) to change the quality.**
- 9 Press the OK button.**
- 10 Use the four-way controller (▲▼) to select [Overwrite] or [Save as].**
- 11 Press the OK button.**  
The resized image is saved.



- Movies cannot be resized.
- You cannot select a larger size than that of the original image.
- You cannot select a higher quality than that of the original image.

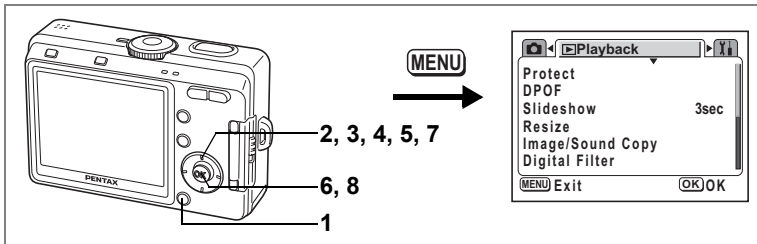

## Editing Pictures with Digital Filters

The digital filters consist of eight color filters (black-and-white, sepia, red, green, blue, black-and-white + red, black-and-white + green, black-and-white + blue), a soft filter, five illustration filters and two special effect filters. The Digital Filter mode enables you to edit pictures using these filters. The image which has been created with the special effect appears on the LCD monitor.



Images that have been edited with the digital filter are saved as “Better (★★)” regardless of the quality of the original image.

6

Playback/Deleting/Editing

### 1 Press the MENU button in Playback mode.

The [▶ Playback] menu appears.

### 2 Use the four-way controller (▲▼) to select [Digital Filter].

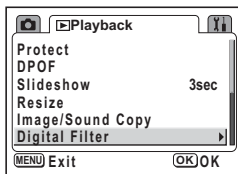

### 3 Press the four-way controller (▶).

An image that can be edited with the digital filters appears.

### 4 Use the four-way controller (◀▶) to choose the image to edit.



**5 Use the four-way controller (▲▼) to choose a digital filter.**

The filter effect is created and the image appears on the LCD monitor. The example shows an image with illustration filter 1 effect.

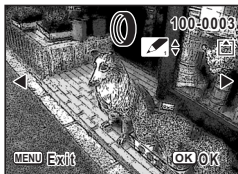

**6 Press the OK button.**

**7 Use the four-way controller (▲▼) to select [Overwrite] or [Save as].**

**8 Press the OK button.**

The image is saved with the digital filter effect.

# Copying Files

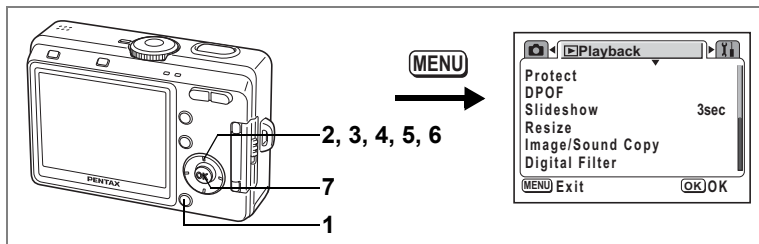

You can copy image and sound files from the built-in memory to the SD Memory Card and vice versa. This function can only be selected when a card has been inserted in the camera.

When files are copied from the built-in memory to the SD Memory Card, all the files are copied at once. When files are copied from the SD Memory Card to the built-in memory, the files are copied one at a time.



Be sure to turn the camera off before inserting or removing the SD Memory Card.

6

Playback/Deleting/Editing

## 1 Press the MENU button in Playback mode.

The [▶ Playback] menu appears.

## 2 Use the four-way controller (▼) to select [Copy image/sound].

## 3 Press the four-way controller (▶).

The Image/Sound Copy screen appears. Choose the copying method you want to use.

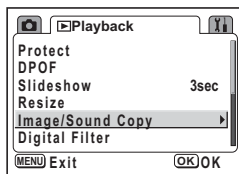

## To Copy Files from the Built-in Memory to the SD Memory Card

- 4 Use the four-way controller (▲▼) to select [📷▶📁] and press the OK button.**

All the files are copied to the SD Memory Card.

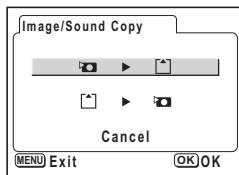

## To Copy Files from the SD Memory Card to the Built-in Memory

- 4 Use the four-way controller (▲▼) to select [📁▶📷] and press the OK button.**
- 5 Use the four-way controller (◀▶) to select the file to copy.**
- 6 Press the OK button.**

The selected file is copied to the built-in memory.



- If the image has a voice memo attached, the voice memo will be copied at the same time as the image.
- When a file is copied from the SD Memory Card to the built-in memory, it is assigned a new file name.

# Camera Settings

How to call the [Set-up] menu

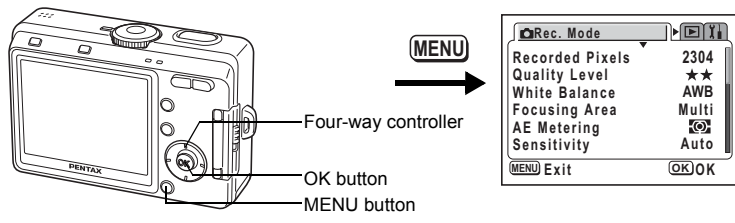

## Formatting an SD Memory Card or the Built-in Memory

Formatting will delete all the data on the SD Memory Card if you are using a card, and all the data in the built-in memory if there is no card inserted.



- Do not turn off the camera or remove the battery or SD card or disconnect the AC Adapter until the formatting is complete or the memory card may be damaged.
- SD Memory Cards formatted on a PC or device other than the camera cannot be used. Be sure to format the card with the camera.
- Formatting will delete protected data too.

7

Settings

**1 Select [Format] on the [Set-up] menu.**

**2 Press the four-way controller (▶).**

The Format screen appears.

**3 Use the four-way controller (▲▼) to select [Format].**

**4 Press the OK button.**

Formatting starts. When formatting is completed, the camera is ready to take pictures.

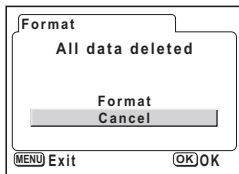

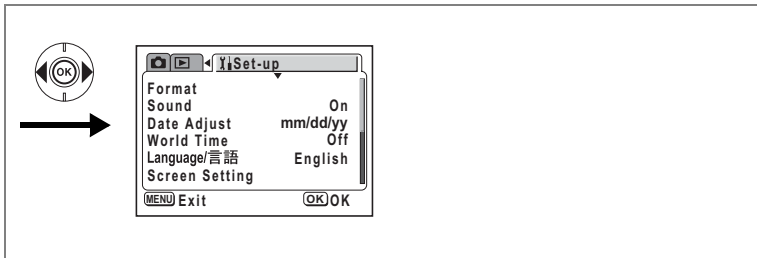

## Changing the Sound Settings

You can adjust the playback volume and the volume of operation sounds, such as the start-up sound, shutter sound and key operation sound. You can also change the type of sound.

### 1 Select [Sound] on the [**Set-up**] menu.

Choosing [0] turns the volume off.

### 2 Press the four-way controller (▶).

The Operation Sound screen appears.

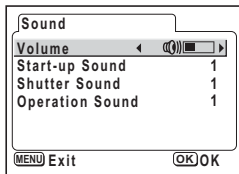

## Changing the Volume

### 3 Press the four-way controller (▲▼) to select [Volume].

### 4 Use the four-way controller (◀▶) to adjust the volume.

### 5 Press the OK button twice.

The camera is ready to take or play back images.

## Changing the Type of Start-up Sound, Shutter Sound and Key Operation Sound

### 3 Use the four-way controller (▲▼) to select [Start-up Sound].

### 4 Use the four-way controller (◀▶) to select [1], [2], [3] or [Off]. Change the [Shutter Sound] and [Operation Sound] in the same way.

### 5 Press the OK button twice.

The camera is ready to take or play back images.



The Sound settings are saved when the camera is turned off.

## How to call the [Y] Set-up] menu

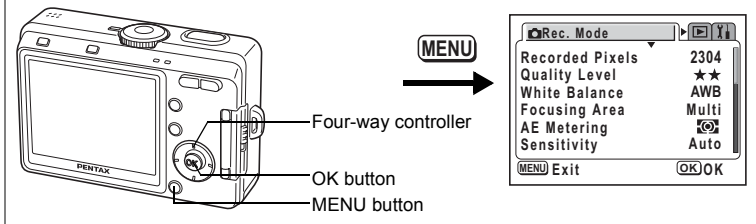

## Changing the Date and Time

You can change the initial date and time settings. You can also set the style in which the date and time appears on the camera.

**1 Select [Date Adjust] on the [Y] Set-up] menu.**

**2 Press the four-way controller (▶).**

The Date Adjust screen appears.

**3 Press the four-way controller (▲▼), to select the date display style.**

Choose [mm/dd/yy], [dd/mm/yy] or [yy/mm/dd].

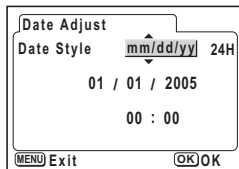

**4 Press the four-way controller (▶).**

The frame moves to [24H].

**5 Press the four-way controller (▲▼), to select the time display style.**

Select [12H] to display the time in a 12 hour format, or select [24] to display the time in a 24 hour format.

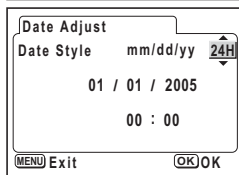



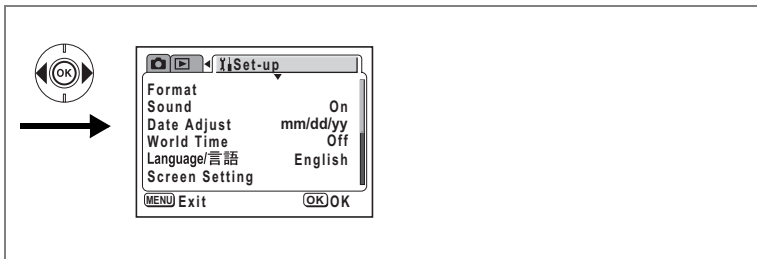

**6 Press the four-way controller (▶).**

The frame moves to month.

**7 Press the four-way controller (▲▼) to change the month.**

Set the day and year in the same manner.

(Pressing the four-way controller (◀) moves the frame to the previous item.)

If you select [12H] in step 3, the setting switches between AM and PM corresponding to the time.

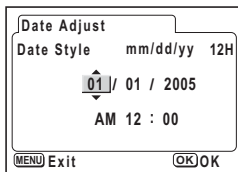

**8 Press the OK button twice.**

The camera is ready to take pictures.

## How to call the [Y] Set-up] menu

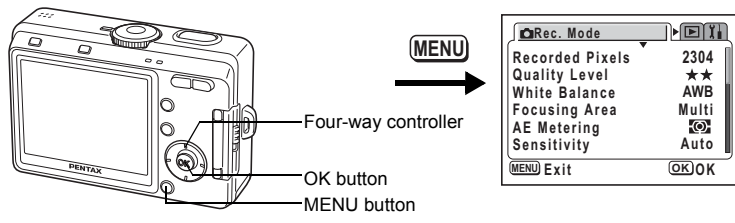

## Setting the World Time

The date and time selected in “Initial Setting” (p.27) serve as the Home Time setting.

You can display the time in a city other than the Home Time city (World Time). This is useful when taking pictures abroad.

**1 Select [World Time] on the [Y] Set-up] menu.**

**2 Press the four-way controller (▶).**

The World Time screen appears.

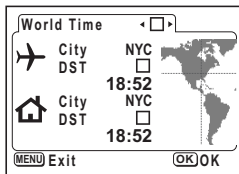

**3 Use the four-way controller (◀▶) to select  or .**

: The time in the city selected in World Time is displayed.

: The time in the city selected in Home Time is displayed.

**4 Press the four-way controller (▼).**

If New York is selected as the World Time city, the location of New York is marked on the world map and ✈ indicates the current time in New York (NYC).

**5 Use the four-way controller (◀▶) to select the ✈ (World Time) city and press the four-way controller (▼).**

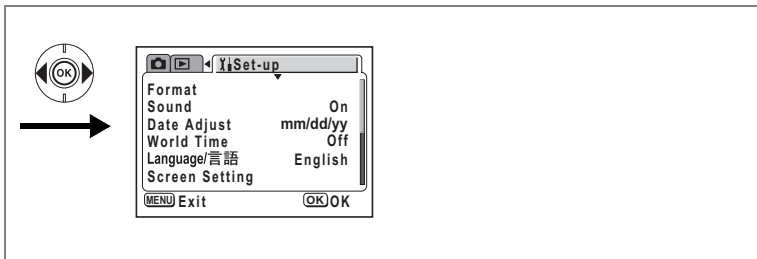

**6 Use the four-way controller (◀▶) to turn [DST]  (On) or  (Off) and press the four-way controller (▼).**

The frame moves to 🏠 (Home Time) city.

The default setting of the 🏠 (Home Time) city is [NYC (New York)].

Use the four-way controller (◀▶) to change the 🏠 (Home Time) city and choose the DST setting.

**7 Press the OK button twice.**

The camera is ready to take or play back images with the time in the selected city.



Refer to page 130 for the list of cities and code names.

## How to call the [Set-up] menu

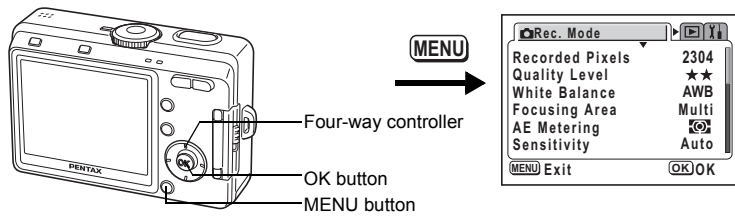

## Changing the Start-up Screen, Background Color and Screen Effects

- 1 Select [Screen Setting] on the [Set-up] menu.
- 2 Press the four-way controller (▶).  
The Screen Setting screen appears.

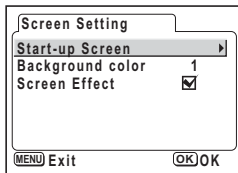

## Changing the Start-up Screen

You can display an image recorded with the camera as the welcome screen when the camera is turned on.

- 3 Use the four-way controller (▲▼) to select [Start-up Screen].
- 4 Press the four-way controller (▶).  
The Change Start-up screen appears.
- 5 Use the four-way controller (◀▶) to select  (On) or  (Off).  
 (On) : Displays the start-up screen  
 (Off) : Hides the start-up screen
- 6 Press the DISPLAY button.
- 7 Use the four-way controller (◀▶) to choose an image for the start-up screen.

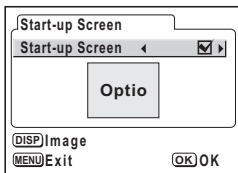

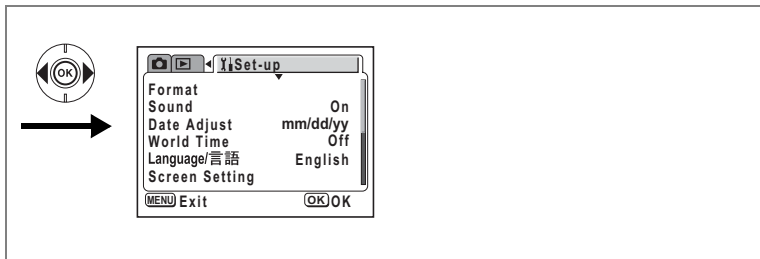

## 8 Press the OK button four times.

The camera is ready to take or play back images.



Once the start-up screen has been set, it will not be deleted even if the original image is deleted or the SD Memory Card or built-in memory is formatted.

## Changing the Background Color

You can choose the background design and color of the LCD monitor.

### 3 Use the four-way controller (▲▼) to select [Background Color].

### 4 Use the four-way controller (◀▶) to choose the background color.

The background color of the menu changes.

### 5 Press the OK button twice.

The camera is ready to take or play back images.

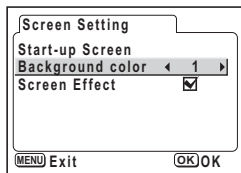

## Using Screen Effects

You can display various animated effects when switching display screens on the LCD monitor.

### 3 Use the four-way controller (▲▼) to select [Screen Effect].

### 4 Use the four-way controller (◀▶) to select (On) or (Off).

### 5 Press the OK button twice.

The camera is ready to take or play back images.

## How to call the [Y] Set-up] menu

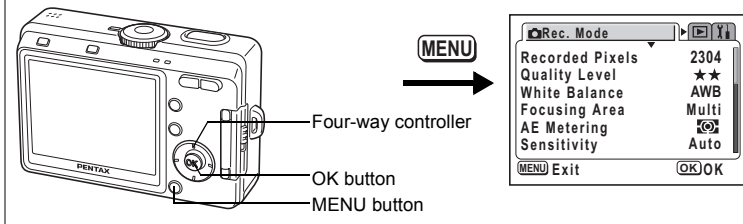

## Changing the Display Language

You can change the language in which the menus, error messages, etc. are displayed.

You can choose from English, French, German, Spanish, Italian, Russian, Korean, Chinese (traditional and simplified) and Japanese.

- 1 Select [Language/言語] on the [Y] Set-up] menu.**
- 2 Use the four-way controller (◀▶) to choose the language.**
- 3 Press the OK button.**

The camera is ready to take or play back images.

7

Settings

## Adjusting the Brightness of the LCD Monitor

You can adjust the brightness of the LCD monitor.

- 1 Select [Brightness Level] on the [Y] Set-up] menu.**
- 2 Press the four-way controller (▶).**  
The Brightness Level screen appears.
- 3 Use the four-way controller (◀▶) to adjust the brightness.**  
The monitor gets darker as the bar slider moves to the left and brighter as it moves to the right.
- 4 Press the OK button twice.**

The camera is ready to take or play back images.

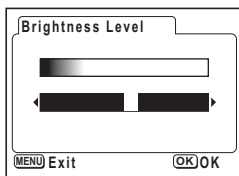

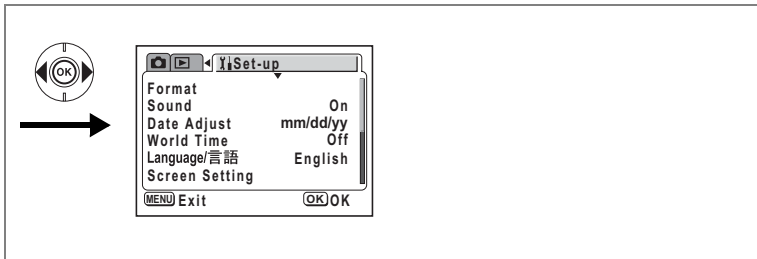

## Changing the Video Output Format

You can choose the output format (NTSC or PAL) for taking or playing back images on a TV or other video device.

- 1 Select [Video Out] on the [Set-up] menu.**
- 2 Use the four-way controller (◀▶) to select [NTSC] or [PAL].**

Choose the video output format to match the output format of the TV or other video device.

- 3 Press the OK button.**

The camera is ready to take or play back images.

## How to call the [Y/I Set-up] menu

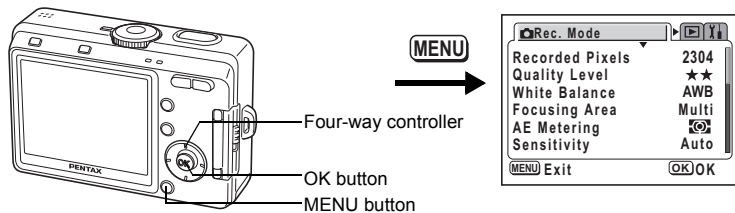

## Changing the USB Connection Mode

You can change the USB connection mode depending on whether the USB cable is to be connected to a printer (PictBridge) or a computer.

- 1 Select [USB Connection] on the [Y/I Set-up] menu.**
- 2 Press the four-way controller (▶).**  
The USB connection mode selection screen appears.
- 3 Press the four-way controller (▲▼) to change the USB connection mode.**

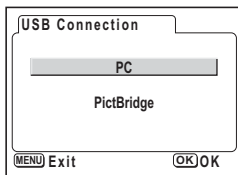

For computers: PC

For printers: PictBridge

- 4 Press the OK button twice.**

The camera is ready to be connected to the computer or printer.



Do not connect the camera to your PC while [PictBridge] is selected for the USB connection mode.



Refer to the "PC Connection Manual" for instructions on connecting the camera to a printer or a computer.

Direct Printing Using PictBridge  p.106



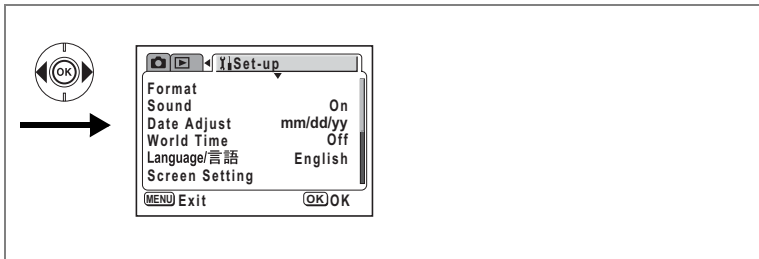

## Setting Auto Power Off

You can set the camera to turn off automatically when no operation is performed for a fixed time.

- 1 Select [Auto Power Off] on the [Set-up] menu.**
- 2 Use the four-way controller (◀▶) to select [2 min], [3 min], [5 min] or [Off].**
- 3 Press the OK button.**

The camera is ready to take or play back images.



The Auto Power Off function will not work when the USB cable is connected.

## Resetting to Default Settings (Reset)

You can reset all the settings other than the date adjust, language/言語 and world time.

- 1 Select [Reset] on the [Set-up] menu.**
- 2 Press the four-way controller (▶).**  
The Reset screen appears.
- 3 Use the four-way controller (▲) to select [Reset].**
- 4 Press the OK button.**

The camera is ready to take or play back images.

## How to call the [Fn Set-up] menu

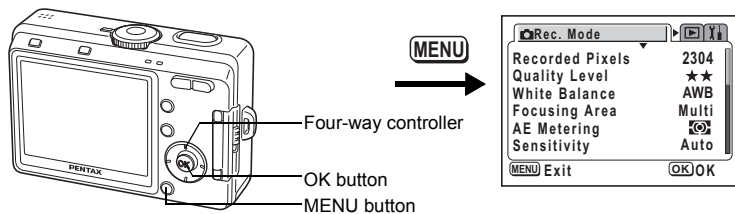

## Registering Functions

You can choose the functions you use most frequently from those listed in the [Rec. Mode] menu and register them on the four-way controller. The functions can then be retrieved in Capture mode by pressing the [Fn/Fn] button to display the Function Mode screen, enabling you to change the setting using the four-way controller.

### Registering a Function

- 1 Select [Fn Setting] on the [Fn Set-up] menu.**
- 2 Press the four-way controller (▶).**  
The Fn Setting screen appears.
- 3 Use the four-way controller (▲▼) to choose a key on which to register a function.**
- 4 Use the four-way controller (◀▶) to choose the function to register.**

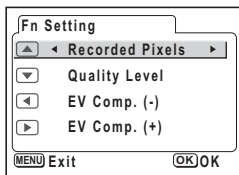

The default settings are as follows: Recorded Pixels on ▲, Quality Level on ▼, EV Compensation (-) on ◀ and EV Compensation (+) on ▶. Select [Off] if you do not want to register a function.

- 5 Press the OK button twice.**

The camera is ready to take or play back images.



- Only one function can be registered on each key of the four-way controller.
- You can choose from the following ten functions: Recorded Pixels, Quality Level, White Balance, Focusing Area, AE Metering, Sensitivity, Sharpness, Saturation, Contrast and EV Compensation (+) / (-). Select [Off] if you do not want to register a function.

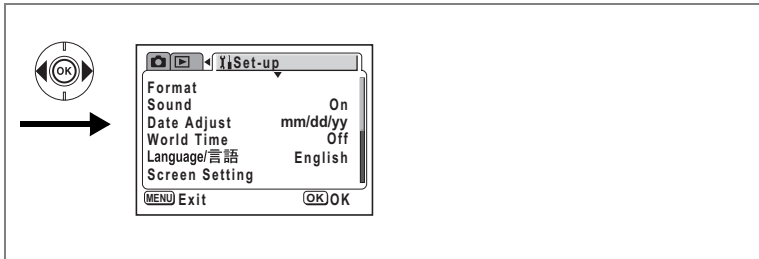

- EV Compensation (+) and (-) must be registered as a pair, with (+) on ▲ and (-) on ▼, or (-) on ◀ and (+) on ▶. It is not possible to register only EV Compensation (+) or (-), or to reverse the plus/minus functions.
- Functions cannot be registered in ☺ (Auto Select) mode.

## Retrieving a Function

**1** Align the mode dial with one of the following; PICT, [P], [Fn], [M], [A], [M].

**2** Press the [Fn]/Fn button in Capture mode.

The functions registered on the four-way controller (▲▼◀▶) appear.



**3** Use the four-way controller (▲▼◀▶) to choose the registered function and change the setting.

Pressing the DISPLAY button when EV Compensation is registered on the four-way controller displays a histogram showing the EV setting. (☞p.81)

When White Balance is registered and you select [M] (manual), press the OK button to adjust the white balance. (☞p.72)

**4** Press the [Fn]/Fn button or the shutter release button.

The setting is saved and the camera is ready to take pictures.



- You cannot access functions by pressing the [Fn]/Fn button in ☺ (Auto Select) mode, [V] (Voice Recording) or [M] (Movie).
- Pressing the [Fn]/Fn button in ☺ (Auto Select Mode) displays the Help screen. (☞p.48)

## List of City Codes

Refer to the following list of city codes when setting the World Time.

TYO	Tokyo	JNB	Johannesburg
GUM	Guam	IST	Istanbul
SYD	Sydney	CAI	Cairo
NOU	Noumea	JRS	Jerusalem
WLG	Wellington	MOW	Moscow
AKL	Auckland	JED	Jeddah
PPG	Pago Pago	THR	Tehran
HNL	Honolulu	DXB	Dubai
ANC	Anchorage	KHI	Karachi
YVR	Vancouver	KBL	Kabul
SFO	San Francisco	MLE	Male
LAX	Los Angeles	DEL	Delhi
YYC	Calgary	CMB	Colombo
DEN	Denver	KTM	Kathmandu
MEX	Mexico City	DAC	Dacca
CHI	Chicago	RGN	Rangoon
MIA	Miami	BKK	Bangkok
YTO	Toronto	KUL	Kuala Lumpur
NYC	New York	VTE	Vientiane
SCL	Santiago	SIN	Singapore
CCS	Caracas	PNH	Phnom Penh
YHZ	Halifax	SGN	Ho Chi Minh
BUE	Buenos Aires	JKT	Jakarta
SAO	Sao Paulo	HKG	Hong Kong
RIO	Rio de Janeiro	PER	Perth
MAD	Madrid	BJS	Beijing
LON	London	SHA	Shanghai
PAR	Paris	MNL	Manila
MIL	Milan	TPE	Taipei
ROM	Rome	SEL	Seoul
BER	Berlin	ADL	Adelaide

# Optional Accessories

A number of dedicated accessories are available for this camera.

**AC adapter D-AC5**

**USB cable I-USB7 (\*)**

**AV cable I-AVC7 (\*)**

**Strap O-ST20 (\*)/Sports strap O-ST30/Leather Strap O-ST24/  
Strap O-ST8**

**Remote control unit E**

**Remote control unit F**

Products marked with an asterisk (\*) are the same as those supplied with the camera.

# Messages

Messages such as the following may appear on the LCD monitor during camera operation.

## Messages during shooting

Compression error	Compression of the image you captured has failed. Change the quality/size and try again.
Memory card full Built-in memory full	The SD Memory Card or the built-in memory is full and no more images can be saved. Insert a new SD Memory Card or delete unwanted images. (p.21, 96) Or change the quality/size and try again. (p.110)
Battery depleted. the image is not stored	The batteries are exhausted. Replace with new batteries. If using rechargeable batteries, charge the batteries (p.16). It may also appear when you turn on the power after purchasing the camera or after replacing the batteries if the batteries had been removed for a long time. (p.25)
Image folder cannot be created.	The largest file number has been assigned to an image and no more images can be saved. Insert a new SD Memory Card or format the SD Memory Card or built-in memory. (p.116)

## Messages during playback

No image/sound	There are no image/sound files on the SD Memory Card or in the built-in memory.
Camera cannot play this image/sound	You are trying to play back an image or sound in a format not supported by this camera. You may be able to play it back on another brand of camera or PC.
The card memory is not enough to copy images & sounds	When copying data from the built-in memory to an SD Memory Card with [Image/Sound Copy], there is not enough space available on the SD Card. You can insert a new SD Memory Card (p.21), delete unwanted data (p.96) or change the quality level and recorded pixels (p.110).
The built-in memory is not enough to copy images & sounds	When copying data from an SD Memory Card to the built-in memory with [Image/Sound Copy], there is not enough space available on the built-in memory. You can delete unwanted data (p.96) or change the quality level and recorded pixels (p.110).

## Messages for both

Memory card error	Shooting and playback are impossible due to a problem with the SD Memory Card. You may be able to play back images or sounds on a PC.
Card not formatted	The SD Memory Card you have inserted is unformatted or has been formatted on a PC or other device and is not compatible with this camera. (p.116)
Card locked	The SD Memory Card is write-protected. (p.22)
Data being recorded	The image is being recorded on the SD Memory Card or in the built-in memory. The protect setting or DPOF setting is being changed. The movie is being recorded.
Deleting	The image is being deleted.
Formatting	The SD Memory Card or built-in memory is being formatted.
Battery depleted	The battery is exhausted. Insert new batteries or if using a rechargeable battery, charge the battery with the charger (p. 16). It may also appear when you turn on the power after purchasing the camera or after replacing the batteries if the batteries had been removed for a long time. (p.16)









Messages such as the following may appear on the LCD monitor when using the PictBridge function.

No paper in the printer	There is no paper in the printer.
No ink in the printer	There is no ink in the printer.
Printer error	An error message has been sent from the printer.
Data error	A data error message has been sent from the printer.
Paper stuck in the printer	The paper in the printer has jammed.

# Troubleshooting

Problem	Cause	Remedy
Camera will not turn on	Batteries are not installed	Check batteries are installed .If not, install batteries.
	Batteries are installed incorrectly	Check orientation of batteries. Reinsert batteries according to the ⊕ ⊖ symbols on the battery compartment. (p.16)
	Battery power is low	Insert new or charged batteries or use the AC adapter.
No image on the LCD monitor	LCD monitor is set to OFF	Press DISPLAY button to turn LCD monitor on. (p.45)
	Camera is connected to a PC by the USB cable	LCD monitor is off when camera is connected to a PC.
	Camera is connected to a TV	LCD monitor is off when camera is connected to a TV.
	Image is displayed but is hard to see	Image on LCD monitor may be hard to see when taking pictures outside in sunlight.
Shutter will not release	Flash is charging	When flash status lamp blinks red, flash is charging and no pictures can be taken. Lamp lights red when charging is completed.
	No available space on SD Memory Card or in built-in memory	Insert SD Memory Card with available space or delete unwanted images. (p.21, 96)
	Recording	Wait until recording is finished.
Picture is dark	Subject is too far away in a dark environment, such as a night scene	Picture becomes dark if subject is too far away. Take picture within range of flash.
	Background is dark	When taking a picture of a person against a dark background, such as a night scene, the background may appear dark if the flash does not reach it even with the correct exposure. Set to  mode to ensure both person and background are clear. (p.44)



Problem	Cause	Remedy
Subject is not in focus	Subject is difficult to focus on	Subjects are difficult to focus on using autofocus: objects with little contrast (blue sky, white walls, etc.), dark objects, finely patterned objects, fast-moving objects, scenery through window or net, etc. Lock focus on another object located at same distance (press shutter release button halfway), then aim at target and press shutter release button fully, or use Manual Focus mode.
	Subject is not in focusing area	Position subject in focus frame (focusing area) in middle of LCD monitor. If the subject is outside the focusing area, aim the camera at the subject and lock the focus (press shutter release button halfway), then compose picture and press the shutter release button fully.
	Subject is too close	Set focus mode on  (Macro) or  (Super Macro). (p.65)
	Focus mode is set on  (Macro) or  (Super Macro)	Normal pictures will be out of focus if taken with focus mode set on  (Macro) or  (Super Macro).
Flash does not discharge	Flash mode is set to Off	Set to Auto or  . (p.67)
	The Capture mode is set to  or  in PICT mode, Continuous Shooting or Infinity-Landscape mode.	Flash will not discharge in these modes.
Zoom will not work	Focus mode is set on Super Macro	Zoom does not function in Super Macro mode.
Even though you have put in a new battery, [Battery depleted] appears.	A long time has elapsed since the batteries were removed previously.	The “Battery depleted” error message may appear when you turn on the power after purchasing the camera or after replacing the batteries if the batteries had been removed for a long time. However, this is not an error. Wait a short period and then turn the power switch on again, the power should come on normally. If this happens, the date and time, recorded pixels and other settings may have been initialized, reset the various settings according to the procedures in “Setting the Shooting Functions” (p.65 to 81) and “Camera Settings” (p.116 to 129).

# Main Specifications

Type	Fully automatic compact digital still camera with built-in zoom lens	
Effective Pixels	4.0 megapixels	
Sensor	4.23 megapixels (total pixels), 1/2.5-inch interline transfer CCD with a primary color filter	
Recorded Pixels	Still Picture	2304×1728 pixels, 2048×1536 pixels, 1600×1200 pixels, 1024×768 pixels, 640×480 pixels
	Movie	320×240 pixels
Sensitivity	Auto, manual (50, 100, 200, 400: Standard Output Sensitivity)	
File Format	Still Picture	JPEG (Exif2.2), DCF, DPOF, Print Image Matching III
	Movie	AVI (Motion JPEG), approx. 30 fps, approx. 15 fps with sound (monaural) *fps = frames per second
	Sound	WAV (PCM system), monaural, max. recording time approx. 15 min. (when using 16 MB SD Memory Card)
Quality Level	★★★ (Best), ★★ (Better), ★ (Good) (In Auto Select Mode) 2304×1728: ★★★ (Superior), 2304×1728: ★★ (Super) 2048×1536: ★★ (Normal), 640×480: ★★ (Economy)	
Storage Medium	Built-in memory (approx. 11 MB), SD Memory Card	

## Approximate Image Storage Capacity (when using the built-in memory (11MB))

Quality Level \ Recorded Pixels	★★★ Best	★★ Better	★ Good	Movie (320×240)	Sound
2304×1728	4	8	12	49 sec. (15 fps)	11 min.
2048×1536	5	9	14		
1600×1200	8	15	21	25 sec. (30 fps)	
1024×768	19	36	48		
640×480	44	69	92		

## Approximate Image Storage Capacity (when using the SD memory card (128MB))

Quality Level \ Recorded Pixels	★★★ Best	★★ Better	★ Good	Movie (320×240)	Sound
2304×1728	49	96	138	9 min. 12 sec. (15 fps)	2 h. 13 min.
2048×1536	62	113	166		
1600×1200	104	178	250	4 min. 45 sec. (30 fps)	
1024×768	227	417	554		
640×480	500	782	1043		

White Balance	Auto, Daylight, Shade, Tungsten Light, Fluorescent Light, Manual	
Lens	Focal Length	5.8 mm - 17.4 mm (equivalent to 35.6 mm - 107 mm in 35 mm format)
	Maximum Aperture	f/2.6 - f/4.8
	Lens Composition	6 elements in 5 groups (two aspherical elements)
	Zoom Type	Electrically driven
	Picture Range	approx. 38.6 mm - approx. 28.9 mm (screen is filled) (Super Macro mode)
	Lens Cover	Electrically driven
Digital Zoom	Capture Mode	Max approx. 2.6× (combines with 3× optical zoom to give zoom magnification equivalent to 8×)
LCD Monitor	2.5-inch TFT color LCD (with backlight) with approx. 115 kilopixels monitor, frame coverage approx. 100%	
Playback Functions	Single-frame, 9-frame index, zoom playback (max up to 12x, scroll possible), rotating (still images only), movie playback, audio playback, voice memo playback, histogram display Slideshow playback, resizing, protect, digital filter and copy (built-in memory↔media), DPOF functions are on the menu. Digital filter (black-and-white, sepia, red, green, blue, black-and-white + red, black-and-white + green, black-and-white + blue, soft, illustration 1, illustration 2, illustration 3, illustration 4, illustration 5, special effect 1, special effect 2.)	
Focusing System	Type	TTL contrast detection system by sensor 5-point multi autofocus (spot autofocus possible)
	Still image/movie focusing range (from lens front)	Normal: 0.4 m - ∞ (full zoom range) Macro: 0.18 m - 0.5 m (full zoom range) Super Macro: 0.06 m - 0.2 m (focal length 10.2 mm) Landscape: ∞ (full zoom range)
	Focus Lock	By half-pressing shutter release button
	Manual Focus	0.18 m - ∞ (0.06 m - ∞ around the focal length midpoint)
Exposure Mechanism	AE Metering	TTL metering by sensor (multi-segment, center-weighted, spot)
	EV Compensation	±2 EV (can be set in 1/3 EV steps)
Movie	Recording time approx. 1 sec. - until memory card is full	
Capture Modes	9 positions (Auto Select, Portrait, Landscape, Night-Scene, Movie, Voice Recording, Digital Effect, Program, Picture)	
Shutter	Type	Electronic/mechanical shutter
	Speed	Approx. 1/2000 sec. - 4 sec.
Flash	Type	Auto flash with red-eye reduction function
	Flash Modes	Auto, flash off, flash on, auto flash + red-eye reduction, flash on + red-eye reduction
	Effective Range	Wide: approx. 0.2 m - approx. 4.9 m (For standard output sensitivity of 400) Tele: approx. 0.2 m - approx. 2.8 m (For standard output sensitivity of 400)
Drive Modes	Single-frame, self-timer mode (10 sec/2 sec), continuous mode, remote control mode (shooting after 3 sec/instant shooting)	
Self-Timer	Electronic control type, delay time: approx. 10 sec., 2 sec.	
Time Function	World Time setting for 62 cities (28 time zones)	
Remote Control Unit	Remote control E, F (sold separately) Both instant shutter release and release after a 3-second delay are possible. Zoom function is available with Remote control E	
Power Supply	Two AA batteries (alkaline, lithium, nickel manganese, Ni-MH Rechargeable battery), one lithium battery CR-V3, AC adapter (optional)	

Battery Life	Recording still images: Approximately 370 images or less (when using the CR-V3 lithium battery) *1 Playback still images: Approximately 450 minutes or less (when using the CR-V3 lithium battery) *2 *1 The image storage capacity is a guideline based on CIPA standard measurement conditions, and may vary depending on actual shooting conditions of use. (Measuring conditions: LCD monitor is on, 50% flash use, 23°C.) *2 The playback times are a guideline based on PENTAX measuring conditions and may vary depending on the actual shooting conditions of use.
In/Out Port	USB/AV terminal, external power supply terminal
Video Output Format	NTSC/PAL (Monaural)
PictBridge	Compatible printers    Printers that support PictBridge Print Modes            Print One    Print All    Print with DPOF Settings
Size	89 (W) × 58.5 (H) × 27.5 (D) mm (excluding operating members and projections)
Weight	135 g (4.6 oz) (excluding batteries and SD Memory Card)
Weight When Shooting	185 g (6.3 oz) (including batteries and SD Memory Card)
Accessories	Two AA alkaline batteries, USB cable, software (CD-ROM), AV cable, strap, operating manual

**Memo**

# WARRANTY POLICY

All PENTAX cameras purchased through authorized bona fide photographic distribution channels are guaranteed against defects of material or workmanship for a period of twelve months from date of purchase. Service will be rendered, and defective parts will be replaced without cost to you within that period, provided the equipment does not show evidence of impact, sand or liquid damage, mishandling, tampering, battery or chemical corrosion, operation contrary to operating instructions, or modification by an unauthorized repair shop. The manufacturer or its authorized representatives shall not be liable for any repair or alterations except those made with its written consent and shall not be liable for damages from delay or loss of use or from other indirect or consequential damages of any kind, whether caused by defective material or workmanship or otherwise; and it is expressly agreed that the liability of the manufacturer or its representatives under all guarantees or warranties, whether expressed or implied, is strictly limited to the replacement of parts as hereinbefore provided. No refunds will be made on repairs by non-authorized PENTAX service facilities.

## Procedure During 12-month Warranty Period

Any PENTAX which proves defective during the 12-month warranty period should be returned to the dealer from whom you purchased the equipment or to the manufacturer. If there is no representative of the manufacturer in your country, send the equipment to the manufacturer, with postage prepaid. In this case, it will take a considerable length of time before the equipment can be returned to you owing to the complicated customs procedures required. If the equipment is covered by warranty, repairs will be made and parts replaced free of charge, and the equipment will be returned to you upon completion of servicing. If the equipment is not covered by warranty, regular charges of the manufacturer or of its representatives will apply. Shipping charges are to be borne by the owner. If your PENTAX was purchased outside of the country where you wish to have it serviced during the warranty period, regular handling and servicing fees may be charged by the manufacturer's representatives in that country. Notwithstanding this, your PENTAX returned to the manufacturer will be serviced free of charge according to this procedure and warranty policy. In any case, however, shipping charges and customs clearance fees to be borne by the sender. To prove the date of your purchase when required, please keep the receipt or bills covering the purchase of your equipment for at least a year. Before sending your equipment for servicing, please make sure that you are sending it to the manufacturer's authorized representatives or their approved repair shops, unless you are sending it directly to the manufacturer. Always obtain a quotation for the service charge, and only after you accept the quoted service charge, instruct the service station to proceed with the servicing.

- This warranty policy does not affect the customer's statutory rights.
- The local warranty policies available from PENTAX distributors in some countries can supersede this warranty policy. Therefore, we recommend that you review the warranty card supplied with your product at the time of purchase, or contact the PENTAX distributor in your country for more information and to receive a copy of the warranty policy.



The CE Mark is a Directive conformity mark of the European Community.

## **For customers in USA**

### **STATEMENT OF FCC COMPLIANCE**

This device complies with Part 15 of the FCC Rules. Operation is subject to the following two conditions: (1) This device may not cause harmful interference, and (2) this device must accept any interference received, including interference that may cause undesired operation.

Changes or modifications not approved by the party responsible for compliance could void the user's authority to operate the equipment.

This equipment has been tested and found to comply with the limits for a Class B digital device, pursuant to part 15 of the FCC Rules.

These limits are designed to provide reasonable protection against harmful interference in a residential installation. This equipment generates, uses and can radiate frequency energy and, if not installed and used in accordance with the instructions, may cause harmful interference to radio communications. However, there is no guarantee that interference will not occur in a particular installation.

If this equipment does cause harmful interference to radio or television reception, which can be determined by turning the equipment off and on, the user is encouraged to try to correct the interference by one or more of the following measures:

- Reorient or relocate the receiving antenna.
  - Increase the separation between the equipment and receiver.
  - Connect the equipment into an outlet on a circuit different from that to which the receiver is connected.
- \* Consult the dealer or an experienced radio/TV technician for help.

## **For customers in Canada**

This Class B digital apparatus meets all requirements of the Canadian Interference - Causing Equipment Regulations.

## **Pour les utilisateurs au Canada**

Cet appareil numérique de la classe B respecte toutes les exigences du Règlement sur le matériel brouilleur du Canada.



**Declaration of Conformity**  
According to 47CFR, Parts 2 and 15 for  
**Class B Personal Computers and Peripherals**

We: Pentax Imaging Company  
A Division of PENTAX of America, Inc.

Located at: 600 12<sup>th</sup> Street, Suite 300  
Golden, Colorado 80401 U.S.A.  
Phone: 303-799-8000 FAX: 303-790-1131

Declare under sole responsibility that the product identified herein complies with 47CFR Parts 2 and 15 of the FCC rules as a Class B digital device. Each product marketed is identical to the representative unit tested and found to be compliant with the standards. Records maintained continue to reflect the equipment being produced can be expected to be within the variation accepted, due to quantity production and testing on the statistical basis as required by 47CFR §2.909. Operation is subject to the following two conditions: (1) This device may not cause harmful interference, and (2) This device must accept any interference received, including interference that may cause undesired operation. The above named party is responsible for ensuring that the equipment complies with the standards of 47CFR §15.101 to §15.109.

Product Name: PENTAX Digital Still Camera

Model Number: Optio S45

Contact person: Customer Service Manager

Date and Place: June 2005, Colorado

**Memo**

**Memo**

**PENTAX Corporation** 2-36-9, Maeno-cho, Itabashi-ku, Tokyo 174-8639, JAPAN  
(<http://www.pentax.co.jp/>)

**PENTAX Europe GmbH (European Headquarters)**  
Julius-Vosseler-Strasse, 104, 22527 Hamburg, GERMANY  
(HQ - <http://www.pentaxeurope.com>)  
(Germany - <http://www.pentax.de>)

**PENTAX U.K. Limited** PENTAX House, Heron Drive, Langley, Slough, Berks  
SL3 8PN, U.K.  
(<http://www.pentax.co.uk>)

**PENTAX France S.A.S.** 12/14, rue Jean Poulmarch, 95106 Argenteuil Cedex, FRANCE

**PENTAX Benelux B.V.** (for Netherlands)  
Spinveld 25, 4815 HR Breda, NETHERLANDS  
(<http://www.pentax.nl>)  
(for Belgium & Luxembourg)  
Weiveldlaan 3-5, 1930 Zaventem, BELGIUM  
(<http://www.pentax.be>)

**PENTAX (Schweiz) AG** Widenholzstrasse 1 Postfach 367 8305 Dietlikon, SWITZERLAND  
(<http://www.pentax.ch>)

**PENTAX Scandinavia AB** P.O. Box 650, 75127 Uppsala, SWEDEN  
(<http://www.pentax.se>)

**PENTAX Imaging Company**  
A Division of PENTAX of America, Inc.

(Headquarters)  
600 12<sup>th</sup> Street, Suite 300 Golden, Colorado 80401, U.S.A.  
(Distribution & Service Center)  
16163 West 45<sup>th</sup> Drive, Unit H Golden, Colorado 80403, U.S.A.  
(<http://www.pentaximaging.com>)

**PENTAX Canada Inc.** 1770 Argenta Road Mississauga, Ontario L5N 3S7, CANADA  
(<http://www.pentaxcanada.ca>)

<http://www.pentax.co.jp/english>



- Specifications and external dimensions are subject to change without notice.