

PENTAX™

Optio S40

(PC Connection Manual)

**Viewing Your Digital
Camera Images
On Your PC**



Introduction



This booklet explains how to view the images you took with the PENTAX Optio S40 on your PC. Keep this manual in a safe place.

Regarding copyrights

Images taken using the Optio S40 that are for anything other than personal enjoyment cannot be used without permission according to the rights as specified in the Copyright Act. Please take care, as there are even cases where limitations are placed on taking pictures even for personal enjoyment during demonstrations, industrial enterprise or as items for display. Images taken with the purpose of obtaining copyrights also cannot be used outside the scope of use of the copyright as laid out in the Copyright Act, and care should be taken here also.

Regarding trademarks

- The SD logo  is a trademark.
- PENTAX is a trademark of PENTAX Corporation.
- Optio is a trademark of PENTAX Corporation.
- All other brands or product names are trademarks or registered trademarks of their respective companies.
- Apple, the Apple logo, AppleScript, the Apple Store, Mac, the Mac logo, Mac OS, Macintosh, and QuickTime are trademarks of Apple Computer, Inc., registered in the U.S. and other countries.
- This product supports PRINT Image Matching II.
When used in combination, PRINT Image Matching II enables digital still cameras, printers and software help photographers to produce images more faithful to their intentions.
Copyright 2001 Seiko Epson Corporation. All Rights Reserved.
PRINT Image Matching is a trademark of Seiko Epson Corporation.
- "PictBridge" allows the user to connect the printer and digital camera directly, using the unified standard for the direct printout of images. You can print images directly from the camera through a few simple operations.
- Symbols used in this manual have the following meanings:

	Gives page numbers explaining related operations.
	Gives information that is useful to know.
	Gives cautions and notes about the operation.

The PC screenshots in this booklet may differ from your PC, depending on your model.

Contents

How to Use the Captured Images	2
Viewing Digital Camera Images on a Windows PC	4
System Requirements	4
Installing the Image Processing Software (ACDSee for PENTAX)	6
Copying Images to your PC	9
Disconnecting the Camera from your PC	14
Viewing Digital Camera Images on a Macintosh	16
System Requirements	16
Installing ACDSee for PENTAX.....	17
Installing ACD Photostitcher	18
Displaying Images on your Macintosh.....	20
Disconnecting your Camera from your Macintosh.....	22
About ACDSee for PENTAX	23
Launching ACDSee for PENTAX	23
Viewing Using the Browser	24
About the Browser	24
Viewing Images in Other Folders	28
Sorting Image Files.....	29
Setting Detailed Display Categories.....	30
Viewing a Large Version of an Image (Viewer)	31
About the Viewer.....	31
Panorama Image Stitching with ACD Photostitcher	33
Panorama Image Stitching on a Windows PC.....	33
Panorama Image Stitching on a Macintosh.....	36
Printing an Image	39
Printing from the Browser.....	39
Printing from the Viewer.....	39
Creating and Printing Contact Sheets	40
E-mailing your Images from ACDSee for PENTAX	41
About ACDInTouch	42

How to Use the Captured Images

Here are some ways to use the images captured with your digital camera.

Direct Print

Connect your camera and a printer that is compatible with "PictBridge" directly with the USB cable, and print images.

☞ Camera Operating Manual (p.97)



View images on a TV

Connect your camera and TV with the AV cable and display images on the TV.

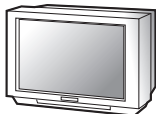

☞ Camera Operating Manual (p.93)

Is your computer...

- equipped with a standard USB interface?
- using Windows Me/2000/XP as your OS? Or Mac OS 9.0-9.2/10.1 or later?

Connect your camera and computer with the USB cable, and copy the camera images.



Is your computer...

- using Windows 95/98/98 SE/NT, Mac OS 8.6?

Transfer your images using a built-in card slot + PC card adapter or a card reader.

- Remove the card from the camera. When transferring images on the card to a PC with another device, make sure to review the user manual accompanying that device.

Use your photo shop

Have prints made from your card images at a photo shop.

- Set DPOF settings on your camera, and get prints from your photo shop.

☞ Camera Operating Manual (p.94)

- Select the images for prints.



Use your image data

Use your e-mail software to attach images to e-mails, or use them on your homepage.



- See the operating manual of your e-mail software for details on how to make attachments to e-mails.
- See the operating manual of the software you are using for details on how to use images on your homepage.

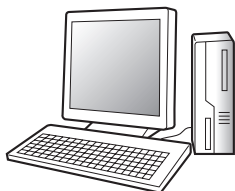

ACDSee for PENTAX ES p.23-41

- View Images
- Save processed images
- Manipulate images
- Edit Images
- E-mail Images
- Print images

• These operations also can be performed using commercially available image editing software. See the instructions provided with the software for more details.

Use your printer

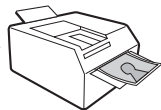

Print images from your computer to your printer. Some printers can print directly from cards.

- For details, see the operating manual of the printer you are using.

Save your image data

Images sent to the computer can be saved onto a CD-R or other media.



Viewing Digital Camera Images on a Windows PC

You can use the provided USB cable (I-USB7) or a card reader to transfer your digital camera's images to the PC, and you can edit and print your images using the image viewing software. Here, the method for viewing images with the provided software (S-SW16) is explained.

Software Provided

The following software is included in the CD-ROM (S-SW16) provided.

- Image viewing / editing software (ACDSee for PENTAX)
- QuickTime™ 6.0

System Requirements

● USB connection

- OS: Windows Me / 2000
Windows XP Home Edition / Professional
- USB port must be standard equipment
- * Installation of the driver is not necessary.

● Application Software

<ACDSee for PENTAX>

(9 languages: English, German, French, Spanish, Italian, Russian, Chinese [traditional and simplified], Korean, Japanese)

- OS: Windows 98 / 98 SE / Me /
NT (latest version) / 2000
Windows XP Home Edition / Professional
- CPU: Pentium or higher recommended
- Memory: 64MB minimum
- Hard Disk space: 40MB minimum
- Display adapter capable of displaying a minimum of 256 colors
- Internet Explorer 4.0.2 or later

- * Some formats may require viewing with QuickTime 6.0 or later and DirectX 8.0 or later.
- * To install ACDSSee for PENTAX, Windows Installer Service Version 2.0 may be required.

You can download DirectX and Windows Installer Service from the following website.

<http://www.microsoft.com/windows/directx>

<http://www.microsoft.com/windows2000/techno/howitzworks/management/installer.asp>

<QuickTime>

(6 languages: English, German, French, Spanish, Italian, Japanese)

- OS: Windows 98 / 98 SE / Me / NT (latest version) / 2000 Windows XP Home Edition / Professional
- CPU: Pentium or higher recommended
- Memory: 128MB minimum
- * Operation is not guaranteed on all PCs meeting the system requirements.

You may play moving pictures using the provided software [ACDSSee for PENTAX] (QuickTime 6.0 or later required).



- The software cannot be used on Windows 95.
- We recommend using the AC Adapter D-AC5 (optional) when connecting your camera to your PC. Your image data could be corrupted if your batteries run out during image transfer.

Installing the Image Processing Software (ACDSee for PENTAX)

This section describes the procedures for installing ACDSee for PENTAX which lets you view and edit recorded images on your computer.



If you are using Windows 2000 or Windows XP, please login as an administrator user before starting installation. Refer to your PC's operating manual for instructions on how to login.

1 Turn your computer on.

2 Insert the CD-ROM (S-SW16) into your CD-ROM drive.

The PENTAX Software Installer screen is displayed on the desktop.

• When the PENTAX Software Installer screen is not displayed

Display the PENTAX Software Installer screen following the steps below.

- 1) Double-click [My Computer] on the desktop.
- 2) Double-click the [CD-ROM drive (S-SW16)] icon.
- 3) Double-click [Setup.exe].

3 Click your applicable language.

You can choose the languages from the displayed screen.

A selection screen to install your desired software is displayed.



4 Click [ACDSee™].

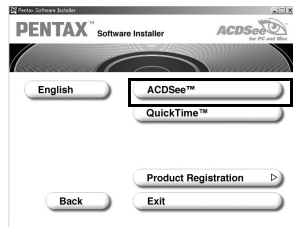

The Setup screen will appear. Follow the on-screen guidance and enter the registration information. Reboot your PC after installation is finished.



- If QuickTime 6.0 or later is not already installed in your PC, a message such as the one shown on the right is displayed before the Setup screen appears. Click [Install QuickTime] to first install QuickTime 6.0.

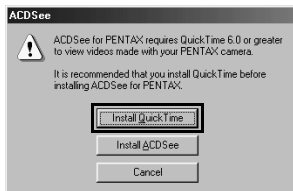

The panoramic image software “Photostitcher”, the image layout and printing software “FotoSlate”, and the image editing software “FotoCanvas” are also installed when you install ACDSee for PENTAX.

Product Registration on the Internet

Please click [Product Registration] on the CD-ROM screen in step 4 on page 6 of this PC manual.

A world map for Internet Product Registration is displayed.

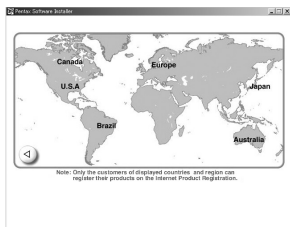

If your PC is connected to the Internet, click the displayed country or region and then follow the instructions to register your product.

Thank you very much for your cooperation.



Only customers in displayed countries and regions can register their products on the Internet Product Registration.

Copying Images to your PC

An explanation of how to copy images using ACDSee for PENTAX is shown below.

Refer to the “About ACDSee for PENTAX” (p.23) to view or edit the copied images.

Setting the USB Connection mode to [PC]

- 1 Press the MENU button.**

The [📷 Rec. Mode] menu or the [▶ Playback] menu will be displayed.

- 2 Press the four-way controller (▶) to display the [⚙️ Set-up] menu.**

- 3 Use the four-way controller (▲▼) to select [USB Connection].**

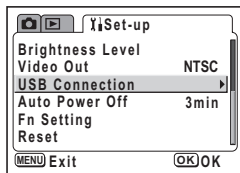

- 4 Press the four-way controller (▶).**

The screen for selecting the USB connection mode appears.

- 5 Use the four-way controller (▲▼) to select [PC].**

- 6 Press the OK button twice.**

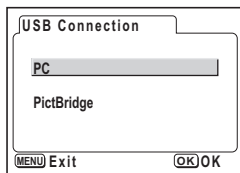

Copying Images to your PC

- 1 Turn your computer on.
- 2 Turn your camera off and connect it to the PC with the USB cable.

Confirm that the SD Memory Card is inserted in the camera when the images in the SD Memory Card are copied.

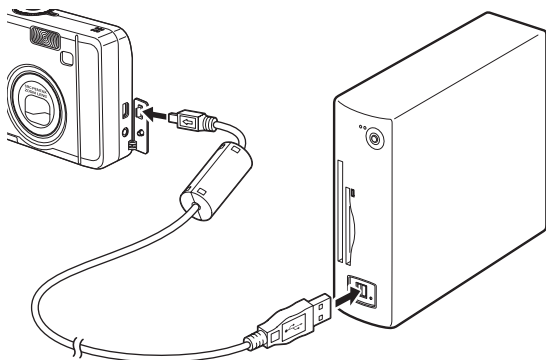

- 3 Turn your camera on.
The Device Detector screen is displayed automatically.
If the Device Detector screen is not displayed, display / copy the images following the steps in “When the Device Detector screen is not displayed” on page 12.
- 4 Confirm that [Copy images to hard drive] and [Launch ACDSee] are checked, and click [Next].

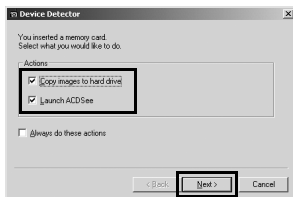

5 Click [Browse].

The [Browse For Folder] screen is displayed.

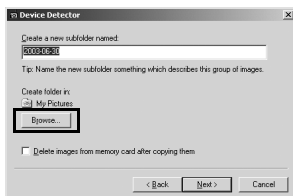

6 Select a destination folder and click [OK].

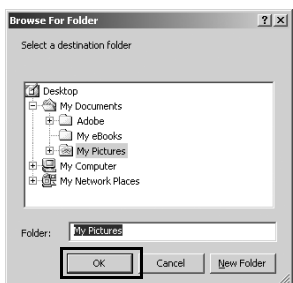

7 Click [Next].

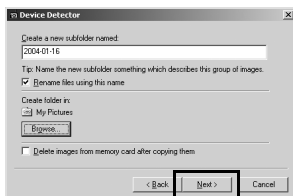

The image is copied to the PC, and the ACDSee for PENTAX Browser starts.



When the Device Detector screen is not displayed

- 4 Double-click the [ACDSee for PENTAX] icon on the desktop.



- 5 Double-click [My Computer].

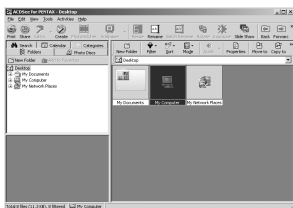

- 6 Double-click [Removable Disk] (if the SD Memory Card has a volume label name, then select that name).

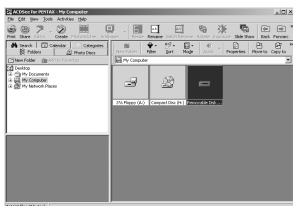

- 7 Double-click the [DCIM] folder.

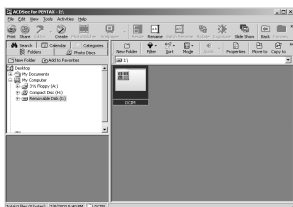

- 8 Click the [xxxPENTX] folder. (xxx is a three-digit number.)

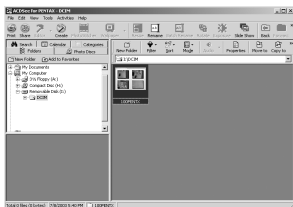

9 Select [Copy To...] from the [Edit] menu.

The Copy Files screen is displayed.



10 Click [More>>] and select the destination folder.

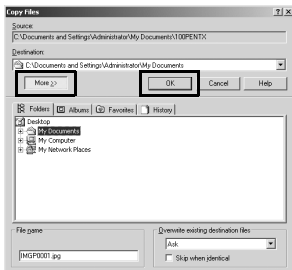

11 Click [OK].

The image is copied to the PC.

Disconnecting the Camera from your PC

Windows 2000 / Me

- 1 Double-click the [Unplug or eject hardware] icon in the task bar recognized area.

The [Unplug or Eject Hardware] screen will appear.



- 2 Confirm that [PENTAX USB DISK Device] is selected and click [Stop].

The [Stop a Hardware device] screen will appear.



- 3 Confirm that [PENTAX USB DISK Device] is selected and click [OK].

A message will appear.



- 4 Click [OK].



- 5 Turn off the camera and disconnect the USB cable from your camera and PC.



- If the camera (removable disc) is being used by an application such as ACDSee, the camera cannot be disconnected until the application is closed.
- In the event that an error message is displayed in Step 4, confirm that the viewfinder lamp is not blinking and then disconnect the camera.

Windows XP

- 1 Double-click the [Safely Remove Hardware] icon in the task bar recognized area.
- 2 Click [PENTAX USB DISK Device] and click [Stop].
- 3 Click [PENTAX USB DISK Device] and click [OK].
- 4 When a message is displayed permitting removal, turn the camera off and disconnect the USB cable from your camera and PC.



Viewing Digital Camera Images on a Macintosh

You can use the provided USB cable (I-USB7) or a card reader to transfer your digital camera's images to the Mac, and you can edit and print your images using the image viewing software. Here, the method for viewing images with the provided software (S-SW16) is explained.

Software Provided

The following software is included in the CD-ROM (S-SW16) provided.

- Image viewing / editing software (ACDSee for PENTAX)
- Panoramic image software (ACD Photostitcher)

System Requirements

● USB connection

- OS: Mac OS 9.0-9.2/10.1 or higher
- USB port must be standard equipment
- * Installation of the driver is not necessary.

● Application Software

<ACDSee for PENTAX and ACD Photostitcher>

(6 languages: English, German, French, Spanish, Italian, Japanese)

- OS: Mac OS 8.6 or higher
(requires QuickTime 4.0 or higher and the latest version of CarbonLib)
- CPU: Power Macintosh 266MHz or higher
- Memory: 8MB minimum
- Hard Disk space: 6MB minimum
- * The classic system is necessary when using ACD Photostitcher with Mac OS X or higher.
- * Operation is not guaranteed on all Macintosh computers meeting the system requirements.

You may play movie pictures taken using the provided software [ACDSee for PENTAX] (QuickTime 4.0 or later required).



We recommend using the AC Adapter D-AC5 (optional) when connecting your camera to your Mac. Your image data could be corrupted if your batteries run out during image transfer.

Installing ACDSee for PENTAX

This section describes the procedures for installing ACDSee for PENTAX which lets you view and edit recorded images on your computer.

- 1 Turn your Macintosh on.**
- 2 Insert the CD-ROM (S-SW16) in the CD-ROM drive.**
- 3 Double-click the CD-ROM (S-SW16) icon.**
- 4 Double-click the [Install ACDSee™] icon.**

The PENTAX Software Installer screen is displayed on the desktop. Double-click the [Master Installer] icon to display [PENTAX Software Installer] screen.

- 5 Click your applicable language.**

You can choose the languages from the displayed screen.

A selection screen to install your desired software is displayed.



- 6 Click your applicable Mac OS.**

The software selection screen will appear.



- 7 Click [ACDSee™].**

The setup screen will appear. Follow the on-screen guidance to input registration information and install the software.

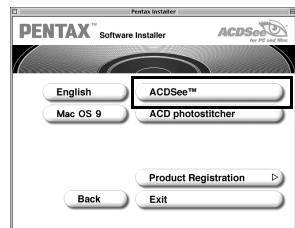



If the message [CarbonLib-xxxxx could not be found] is displayed during installation, you must add the function expansion file called “CarbonLib” to the function expansion folder in the system folder in order to install the provided software in Mac OS 8.6 - 9.2. This error message appears when this function expansion file is not present or when an old version of the file is present. The latest version of the CarbonLib is available on the Apple website. Download the file and then install it. Apple website: <http://www.apple.com> Contact Apple for detailed information on how to use CarbonLib.

Installing ACD Photostitcher

This section describes the procedures for installing ACD Photostitcher which lets you join a number of images together to form a panorama picture.

1 Double-click [ACD photostitcher].

The licensing agreement will appear on the screen. When you have read it, click [Agree] to accept the terms of the agreement.

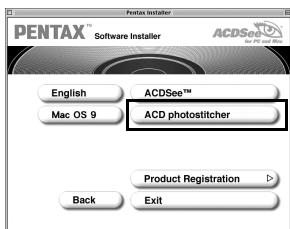

2 Choose a destination for the software and click [Install].

Installation starts. When the message appears telling you that the software has been successfully installed, click [Quit].



Product Registration on the Internet

Please click [Product Registration] on the CD-ROM screen in step 7 on page 17 of this PC manual.

A world map for Internet Product Registration is displayed.

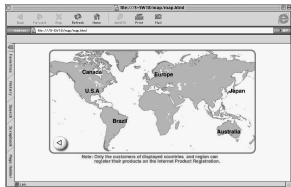

If your PC is connected to the Internet, click the displayed country or region and then follow the instructions to register your product.

Thank you very much for your cooperation.



Only customers in displayed countries and regions can register their products on the Internet Product Registration.

Displaying Images on your Macintosh

Setting the USB Connection mode to [PC]

- 1 Press the MENU button.**

The [📷 Rec. Mode] menu or the [▶ Playback] menu will be displayed.

- 2 Press the four-way controller (▶) to display the [⌘ Set-up] menu.**

- 3 Use the four-way controller (▲ ▼) to select [USB Connection].**

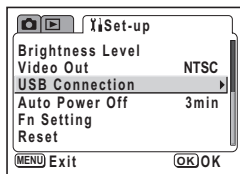

- 4 Press the four-way controller (▶).**

The screen for selecting the USB connection mode appears.

- 5 Use the four-way controller (▲ ▼) to select [PC].**

- 6 Press the OK button twice.**

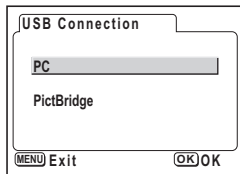

Displaying images on your Macintosh

- 1 Turn your Macintosh on.**
- 2 Turn your camera off and connect it to the Macintosh with the USB cable.**

Confirm that the SD Memory Card is inserted in the camera when the images in the SD Memory Card are displayed.

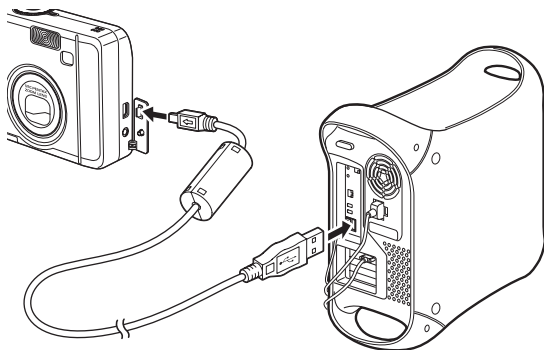

- 3 Turn your camera on.**

The camera is recognized as [untitled] ([NO_NAME] in Mac OS X) on the desktop. The folder name can be changed.



- 4 Double-click the [ACDSee™] folder on the desktop.**
- 5 Double-click the [ACDSee™] program icon.**

An image list (Browser) is displayed.

- 6 Open the camera folder.**

The camera images are in the [untitled] (or volume label name if the SD Memory Card has one) → [DCIM] → [XXXPENTX] (XXX is a three-digit number) folder.

An image list of the camera is displayed.

7 Select the image to view from the image list.

Double-click the image you selected. A full-size image is displayed (Viewer).



If the SD Memory Card has a volume label, the volume label name will be displayed instead of “untitled”. A new SD Memory Card unformatted may show the manufacturer name or model number.

Copying images to your Macintosh

See your Macintosh user’s manual for how to copy or move files. Please copy images to your Macintosh before editing them.

Disconnecting your Camera from your Macintosh

- 1 Drag [untitled] (or the volume label name on the SD Memory Card) to your trash.**
- 2 Disconnect the USB cable from your camera and your Macintosh.**

About ACDSee for PENTAX

“ACDSee for PENTAX” is an integrated software package that acquires, organizes, displays, processes and shares digital camera images.

You can use the Browser (☞ p.24) to acquire digital camera images efficiently. You then can organize them in your favorite way and even display them as thumbnails.

You can use the Viewer (☞ p.31) to view a large version of a single image.

Further, when you install “ACDSee for PENTAX” which is on the provided CD-ROM (S-SW16) on a Windows PC, the panoramic image software “Photostitcher” (☞ p.33), the image layout software “FotoSlate”, and the image editing software “FotoCanvas” are also installed at the same time. Use this software to enjoy an even higher degree of freedom in your image creation, editing and processing.

This manual provides explanations regarding the most basic “ACDSee for PENTAX” functions. Refer to the Help section in “ACDSee for PENTAX” for detailed information.

Launching ACDSee for PENTAX

For Windows

- 1 Double-click the [ACDSee for PENTAX] icon on the desktop.**

ACDSee for PENTAX will launch and an image list (Browser) will be displayed.

For Macintosh

- 1 Double-click the [ACDSee for PENTAX] folder on the desktop.**
- 2 Double-click the [ACDSee for PENTAX] program icon.**

ACDSee for PENTAX will launch and an image list (Browser) will be displayed.

To exit ACDSee for PENTAX

Select [Exit] from the [File] menu in the Browser or the Viewer.

Viewing Using the Browser

In “ACDSee for PENTAX”, you can view images using either the Browser, which displays a list of images, or the Viewer, which displays one image at a time.

The Browser is displayed when you launch “ACDSee for PENTAX.”

About the Browser

Here, explanations are provided regarding Browser configuration as well as names and functions within the Browser.

For Windows



① Menu bar

You can select and execute the various functions and settings of the ACDSee for PENTAX by choosing the menu items from the menu bar.

② Browser toolbar

Browser toolbar includes shortcut buttons for commonly used functions and tools. These buttons open dialog boxes or display further activity buttons.

You can customize the toolbar for easy use by turning the button labels on or off, adding or removing buttons, and changing the size of the buttons.

③ Navigation pane

Navigation pane displays a folder tree of the folders on your computer, extra drive, or peripheral device.

Navigation pane includes the Folders, Calendar, Categories, Photo Discs, and Albums tabs. You can select these tabs to display their respective contents in the File pane, or to organize your files and folders.

④ Preview pane

Preview pane displays the image selected in the File pane.

⑤ File list toolbar

With these shortcut buttons, you can copy, move or delete items, select what file types or folders to display in the File pane, and sort your images. You can customize the toolbar for easy use by turning the button labels on or off, adding or removing buttons, and changing the size of the buttons.

⑥ Path box

Path box describes the location of the folder of images currently displayed in the File pane.

⑦ File pane

File pane displays the contents of a folder selected in the Navigation pane as a list of files or as thumbnails.

You can sort your images by such criteria as file name, file extension, file size, file date, etc.

⑧ Status bar

Status bar displays information and properties for the selected folder, file or files.



When these categories are not displayed, check () the categories you want to display in the [View] menu.

For Macintosh



① Menu bar

You can select and execute the various functions and settings of the ACDSee for PENTAX by choosing the menu items from the menu bar.

② Browser toolbar

Browser toolbar includes shortcut buttons for commonly used functions and tools. These buttons open dialog boxes or display further activity buttons.

③ Navigation pane

Navigation pane displays a folder tree of the folders on your computer, extra drive, or peripheral device.

④ Preview pane

Preview pane displays the image selected in the File pane.

⑤ File pane

File pane displays the contents of a folder selected in the Navigation pane as a list of files or as thumbnails.

You can sort your images by such criteria as file name, file size, file date, etc.

Changing the Browser display method

You can select any of the following 6 methods to display lists of images in the Browser.

Select [Mode] in the [View] menu and then select a display method from the submenu. You can choose from the following display methods.

Thumb+Details

Display image file thumbnails and file information in a list format. You can change the file information that is displayed. (☞ p.30)

Thumbnails

Display image file thumbnails.

Large Icons

Display large icons and file names.

Small Icons

Display small icons and file names.

List

Display small icons and file names in a list format.

Details

Display small icons and file information in a list format. You can change file information that is displayed. (☞ p.30)





Viewing Images in Other Folders

To view images stored in other folders, select a folder from the folder tree in the Browser Navigation pane or directly specify a folder in the path box.

Selecting a different folder in the folder tree

Folders selected from the folder tree are designated as the current folder and images from that folder are displayed in the File pane.



To display a subfolder

 is displayed next to the folder icon of folders that contain subfolders. Click  to display the subfolders.  is displayed next to folders when subfolders are displayed. Click  to hide the subfolders.

Use the buttons on the Browser toolbar to select a different folder.

You can view the contents of the folder one level above the current folder by clicking  in the Browser toolbar.

You can view the contents of the folder displayed prior to the current folder by clicking  in the Browser toolbar.

Click  to return to the folder displayed before you used  in the Browser toolbar to change the displayed folder.

Specifying a different folder using the Path box

Select [Path Box] from the [View] menu to display the path box in the File pane. Directly enter in the path box the path of the folder containing images you want to view. Images in that folder are displayed in the File pane.

Also, click  to the right of the path box to display a dropdown list containing a history of recently used folders. Select from the list a folder with images you want to view. Images from that folder are displayed in the File pane.

Sorting Image Files

You can change the order of image files displayed in the File pane.

Selecting sort categories

Select [Sort] from the [View] menu and then select a sort key category from the submenu.

You can choose from the following categories.

Extension, Name, Size, Type, Date, Image Properties, Description

Specifying ascending / descending order

Select [Sort] from the [View] menu and then select [Forward] or [Reverse] from the submenu.



- Clicking the right mouse button on the File pane background (empty area where images are not displayed as thumbnails or icons) will display the menu in the location of the cursor. You can use the same step to rearrange the menus.
- For Macintosh, you can choose from the following categories: File Name, File Size, Image Type, Date and Reverse Sort Order.

Sorting using the keyboard

You also can sort image files and specify ascending / descending order using the numeric keypad on the keyboard.

0: Extension	4: Date
1: Name	5: Image Properties
2: Size	6: Description
3: Type	+: Forward
	-: Reverse



Enable NumLock by pressing the NumLock key on the keyboard when you want to sort using the numeric keypad.

Setting Detailed Display Categories

You can specify items displayed in the list as well as change the category order when the File pane is set to Details display.

Settings display categories

Select [Columns] from the [View] menu and then select a display category from the submenu.

You can choose from the following categories.

Size, Type, Date, Image Properties, Description

Select another category to remove checks when you do not want to display details.



Clicking the right mouse button on the file list row header (portion where name, size, and other categories are written) will display the menu. You can use the same step to set the display categories.

Adjusting the width of display category rows

You can adjust the row width to match the amount of text for each item displayed in the list. Align the cursor with the edge of the row header. Click on the edge when the cursor changes to a left-right arrow head and drag the edge to adjust the row width.



Double-clicking the left mouse button on the row header separator will automatically adjust the row width to match the length of the list text.

Viewing a Large Version of an Image (Viewer)

Double-click on a single image file selected in the Browser to display a full-screen view of that image.

About the Viewer

Here, explanations are provided regarding Viewer configuration as well as names and functions within the Viewer.



① Menu bar

You can select and execute the various functions and settings of the ACDSee for PENTAX by choosing the menu items from the menu bar.

② Viewer toolbar

Viewer toolbar includes shortcut buttons for commonly used functions and tools such as the Zoom tools.

You can customize the toolbar for easy use by turning the button labels on or off, adding or removing buttons, and changing the size of the buttons.

③ Viewer pane

Viewer pane displays your images one at a time in full resolution.

④ Status bar

Status bar displays information and properties for the selected folder, file or files.



When the viewer is displayed, you can close the viewer and switch to the browser by performing any of the following.

- Click the  (close) button.
- Double-click on the viewer pane border.
- Press the [Esc] key on the keyboard.

Panorama Image Stitching with ACD Photostitcher

With ACD Photostitcher installed on a Windows PC, you can panorama stitch the images you took in Panorama Assist mode. The folder and image names displayed on the explanatory screenshots will differ according to the setup of your PC.



- If you are using Windows 2000 or Windows XP, please login as an administrator user before starting installation.
- Install ACD Photostitcher and ACDSee for PENTAX separately when using a Macintosh.
- Panorama stitching cannot be performed on images of varying save sizes.

Panorama Image Stitching on a Windows PC

1 Run ACDSee for PENTAX.

An image list is displayed.

2 Select the images for panorama stitching from the image list.

Press the [Ctrl] key on the keyboard while clicking on pictures to select multiple images.

After selecting the images, select [Extras] from the [Activities] menu, and select [Photostitcher] from the submenu.

The [Photostitcher] is not enabled if two or more images are not selected.

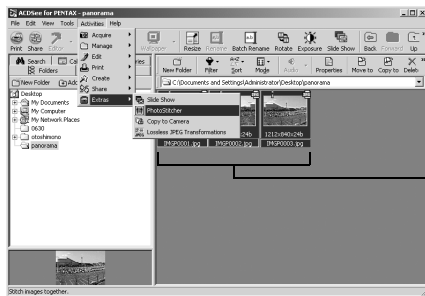

Select images

3 Correct the image positioning.

ACD Photostitcher starts, and the selected images are displayed in panorama format.

Move the mouse pointer onto the image. It changes into a  symbol. Hold down the left mouse button and drag the images to adjust the stitching position.

When the position is adjusted, click the [STITCH] button.



4 Select the stitching method.

You can choose the stitching method from [Big Plane] and [Cylinder].

Here, you will create a flat panorama. Click the [Big Plane] button.

A confirmation message is displayed. Click [OK].

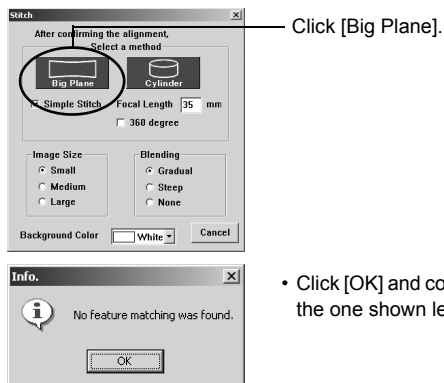

- Click [OK] and continue if a screen like the one shown left is displayed.

5 Trim the image.

Move the mouse pointer onto an image. It changes into a \updownarrow symbol. Hold down the left mouse button and drag the dotted lines to adjust the image trimming position.

When the position is adjusted, click the [Trimming] button.

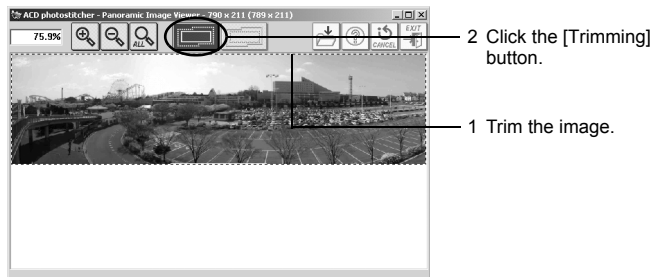

6 Save the image.

After confirming your trimming, click the [Save] button to save the image. To cancel the trimming, click the [Cancel Trimming] button. When you are done, close ACD Photostitcher and ACDSee for PENTAX.

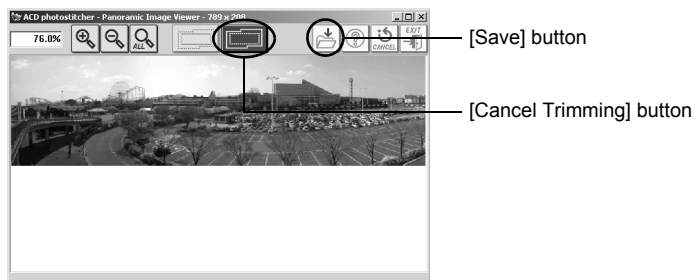

Panorama Image Stitching on a Macintosh

1 Run ACD Photostitcher.

2 Click the [Load] button.

The folder selection screen is displayed.

3 Select the folder for panorama stitching, and then click the [Choose] button.

The image files in the selected folder are displayed.

4 Select all the images for panorama stitching and then click the arrow on the right.

The selected images are displayed on the image layout palette in the alignment window.

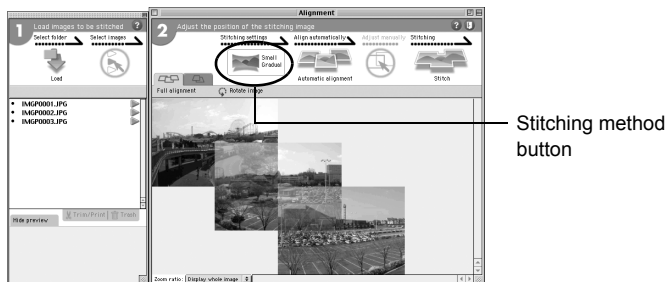

5 Setting the stitching parameters.

Click the Stitching method button to open the stitching parameter selection window.

You can choose the stitching method from [Big Plane] and [Cylinder]. Here, you will create a flat panorama. Choose the [Big Plane] button and click [OK].

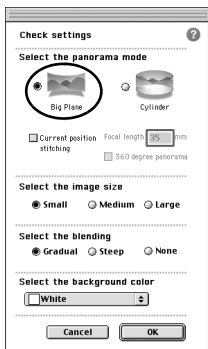

6 Click the [Automatic alignment] button.

The selected images are displayed in panorama format.

7 Correct the image positioning.

Click the image you want to move and display it in a red frame. Hold down the mouse button and drag the image to adjust the stitching position.

For easier adjustment of two images that are next to each other, click the [Align 2 images] tab to enlarge the section where the images overlap.

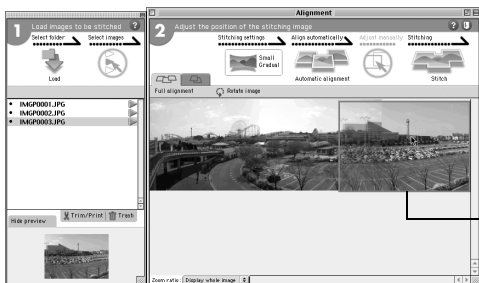

8 Click the [Stitch] button.

Stitching starts. When finished, the stitched picture is displayed.

9 Trim the image.

Click the [Trim] button to display the dotted lines around the image. Move the mouse pointer onto the dotted lines. It changes into a \updownarrow symbol. Hold down the mouse button and drag the dotted lines to adjust the image trimming position.

When the position is adjusted, click the [Trim] button again.

To cancel the trimming, click the [Undo] button.

After confirming your trimming, click [OK].

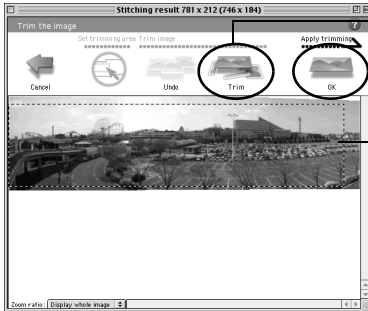

1 Click the [Trim] button.

3 Click the [Trim] button.

4 Click the [OK] button.

2 Trim the image.

10 Save the image.

Click the [Save] button to save the image.

When you are done, close ACD Photostitcher.



Printing an Image

You can print image files from the Browser or the Viewer.

Printing from the Browser

You can print images from the Browser.

- 1 Select one or more images.**
To print several images, hold the [Ctrl] key on the keyboard while clicking on all the pictures you want to print.
- 2 Select [Print Images] from the [File] menu.**
The Print dialog box is displayed.
- 3 Select or change the printing options.**
- 4 Click [Print].**

Printing from the Viewer

You can print the currently viewed image, or all images that reside in the same folder as the currently viewed image.

- 1 Select [Print Image] from the [File] menu to print the currently viewed image.**
or
Select [Print All Images] to print all images in the same folder.
The Print dialog box is displayed.
- 2 Select or change the printing options.**
- 3 Click [Print].**

To insert the date and print images

You can insert the date into an image file and print it. Date insertion settings are done in the Print dialog box.

- 1 Select the [Caption] tab in the Print dialog box.
- 2 Check the [Print image capture date in the corner of images] check box.

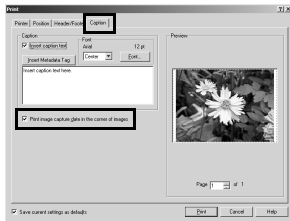

Creating and Printing Contact Sheets

You can create and print contact sheets (thumbnails) of your images. You can add captions to each image, page headers and footers, and control thumbnails size.

- 1 **In the Browser, select a group of images.**
Hold the [Ctrl] key on the keyboard while clicking on all the pictures you want to print.
- 2 **Select [Print Contact Sheet] from the [File] menu.**
The Print Contact Sheet dialog box is displayed.
- 3 **Select or change the printing options.**
- 4 **Click [OK].**



For more information about creating and printing contact sheets, click the Help button in the Print Contact Sheet dialog box.

E-mailing your Images from ACDSee for PENTAX

You can send images directly from the ACDSee for PENTAX without using an external e-mail application. Image files are converted to JPEG format then attached to an e-mail and sent. Images are compressed before transmission when the file size is large but no changes are made to the original image. (E-mail account setup is required to send images. See the ACDSee for PENTAX Help section for details.)



E-mail function of ACDSee for PENTAX is not compatible with Macintosh.

1 In the Browser, select an image or a group of images.

To select several images, hold the [Ctrl] key on the keyboard while clicking on all the pictures you want to send.

2 Select [Share] from the [Activities] menu, then select [E-mail].

The Send E-mail dialog box is displayed.

3 Input the required information.

4 Click [Send].

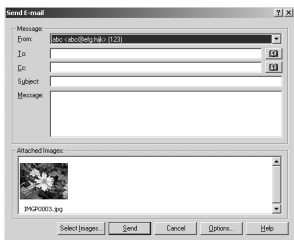

For more information about e-mailing your images, click the Help button in the Send E-mail dialog box.



An error message may be displayed and you may not be able to send mail if your mail server security is set to a high level.

About ACDInTouch

ACDInTouch is an Internet-based service that provides the latest information about ACDSee. You can obtain information about special offers and free digital imaging materials as well as subscribe to the latest news and tips.

To connect to ACDInTouch

1 Select [ACDInTouch] from the [Help] menu.

The Connect to ACDInTouch dialog box is displayed.

2 Click [Connect Now].

About the ACDInTouch services

ACDInTouch is a service for sending information directly to ACDSee. When you connect, information is sent to you so that you can read up-to-date information directly in the ACDInTouch pane. This information is relevant to your product, such as upgrades, add-ons and related software from ACD Systems that may also be of interest to you.

Memo

Memo

Memo

PENTAX Corporation	2-36-9, Maeno-cho, Itabashi-ku, Tokyo 174-8639, JAPAN (http://www.pentax.co.jp/)
PENTAX Europe GmbH (European Headquarters)	Julius-Vosseler-Strasse, 104, 22527 Hamburg, GERMANY (HQ - http://www.pentaxeuropa.com) (Germany - http://www.pentax.de)
PENTAX U.K. Limited	PENTAX House, Heron Drive, Langley, Slough, Berks SL3 8PN, U.K. (http://www.pentax.co.uk)
PENTAX France S.A.S.	12/14, rue Jean Poulmarch, 95106 Argenteuil Cedex, FRANCE
PENTAX Benelux B.V.	(for Netherlands) Spinveld 25, 4815 HR Breda, NETHERLANDS (http://www.pentax.nl) (for Belgium & Luxembourg) Weiveldlaan 3-5, 1930 Zaventem, BELGIUM (http://www.pentax.be)
PENTAX (Schweiz) AG	Widenholzstrasse 1 Postfach 367 8305 Dietlikon, SWITZERLAND (http://www.pentax.ch)
PENTAX Scandinavia AB	P.O. Box 650, 75127 Uppsala, SWEDEN (http://www.pentax.se)
PENTAX U.S.A., Inc	600 12 th Street, Suite 300 Golden, Colorado 80401, U.S.A. (http://www.pentax.com)
PENTAX Canada Inc.	1770 Argentia Road Mississauga, Ontario L5N 3S7, CANADA (http://www.pentaxcanada.ca)



- Printed on recycled paper
- Specifications and external dimensions are subject to change without notice.