

PENTAX™

Digital Camera

Optio *MX4*

Operating Manual

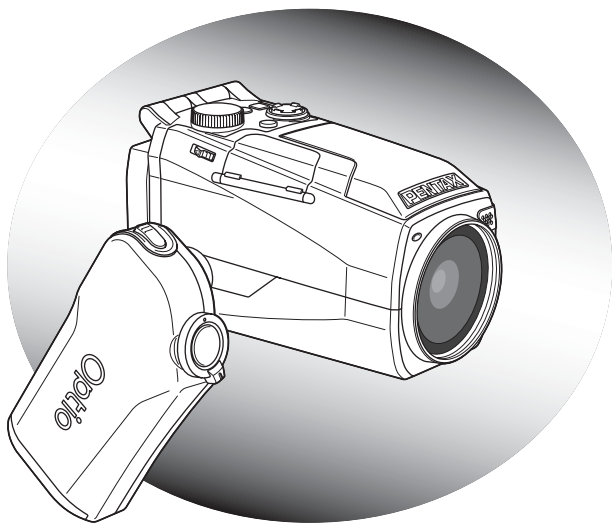

To ensure the best performance from your camera, please read the Operating Manual before using the camera.

Thank you for purchasing the PENTAX Optio MX4 Digital Camera. Please read this manual before using the camera in order to get the most out of all the features and functions. Keep this manual safe, as it can be a valuable tool in helping you to understand all the camera's capabilities.

Regarding copyrights

Images taken using the Optio MX4 that are for anything other than personal enjoyment cannot be used without permission according to the rights as specified in the Copyright Act. Please take care, as there are even cases where limitations are placed on taking pictures even for personal enjoyment during demonstrations, industrial enterprise or as items for display. Images taken with the purpose of obtaining copyrights also cannot be used outside the scope of use of the copyright as laid out in the Copyright Act, and care should be taken here also.

Regarding trademarks

- PENTAX, Optio and smc PENTAX are trademarks of PENTAX Corporation.
- The SD logo  is a trademark.
- All other brands or product names are trademarks or registered trademarks of their respective companies.

To users of this camera

- There is a possibility that recorded data may be erased or that the camera may not function correctly when used in surroundings such as installations generating strong electromagnetic radiation or magnetic fields.
- The liquid crystal panel used in the LCD display is manufactured using extremely high precision technology. Although the level of functioning pixels is 99.99% or better, you should be aware that 0.01% or fewer of the pixels may not illuminate or may illuminate when they should not. However, this has no effect on the recorded image.

This product supports PRINT Image Matching III. PRINT Image Matching enabled digital still cameras, printers and software help photographers to produce images more faithful to their intentions. Some functions are not available on printers that are not PRINT Image Matching III compliant.

Copyright 2001 Seiko Epson Corporation. All Rights Reserved.

PRINT Image Matching is a trademark of Seiko Epson Corporation.

The PRINT Image Matching logo is a trademark of Seiko Epson Corporation.

Regarding PictBridge

PictBridge allows the user to connect the printer and digital camera directly, using the unified standard for the direct printout of images. You can print images directly from the camera through a few simple operations.

- There is a possibility that the illustrations and the display screen of the LCD monitor in this manual are different from the actual product.

FOR SAFE USE OF YOUR CAMERA

Sufficient attention has been paid to the safety of this product but please pay particular attention to the warnings indicated by the following symbols during use.



Warning

These symbols indicate that it is possible that the user may experience serious difficulties if the warnings are not heeded.



Caution

These symbols indicate that it is possible that the user may experience minor or middling difficulties or physical difficulties if the warnings are not heeded.

About the Camera



Warning

- Do not attempt to take the camera apart or remodel the camera. High voltages are present within the camera, and there is therefore a danger of electric shocks.
- If the inside of the camera should become exposed as a result of, for example, the camera being dropped, please do not under any circumstances touch such exposed portions, as there is a danger of receiving an electric shock.
- To avoid the risk of it being swallowed by mistake, keep the SD Memory Card out of the reach of small children. Seek medical attention immediately if accidentally swallowed.
- Wrapping the strap of the camera around your neck is also dangerous. Please take care that small children do not hang the strap around their necks.
- If the camera emits smoke or a strange smell, or in the event of any other irregularity, stop using the camera immediately, remove the battery and disconnect the AC adapter and contact your nearest PENTAX service center. Continued use of the camera may result in fire or electric shock.

Caution

- Never try to disassemble or short the battery. Also, do not dispose of the battery in fire, as it may explode.
- Do not charge any batteries other than rechargeable lithium-ion battery D-LI7. The battery could explode or catch fire.
- Do not place your finger on the flash when it is discharging as there is a risk of burns.
- Do not discharge the flash while it is touching your clothing as there is a risk of discoloring.
- If any of the battery leakage should come in contact with your eyes, do not rub them. Flush your eyes with clean water and get medical attention immediately.
- If any of the battery leakage should come in contact with skin or clothes, wash the affected areas thoroughly with water.
- Remove the battery from the camera immediately if it becomes hot or begins to smoke. Be careful not to burn yourself during removal.
- Some portions of the camera heat up during use, so please take care, as there is a risk of low temperature burns if such portions are held for long periods of time.
- Should the LCD be damaged, be careful of glass fragments. Also, be careful not to allow the liquid crystal to get on your skin or eyes or in your mouth.

About the AC Adapter

Warning

- Do not use the product at a voltage other than the specified voltage. Use with a power source or voltage other than that designed can cause a fire or electrical shock. The specified voltage is 100-240V AC.
- Do not disassemble or modify the product. This can cause a fire or electrical shock.
- If the generation of smoke or strange odor from the product or other abnormality occurs, immediately discontinue using and consult a PENTAX Service Center. Continuing to use the product can cause a fire or electrical shock.
- If water should happen to get inside the product, consult a PENTAX Service Center. Continuing to use the product can cause a fire or electrical shock.

- If lightning should be present during using, unplug the power cord and discontinue using. Continuing to use the product can cause damage to the equipment, fire or electrical shock.
- Wipe off the plug of the power cord if it should become covered with dust. This can cause a fire.



Caution

- Do not place heavy objects on the AC plug cord, allow heavy objects to drop onto it or allow the AC plug cord to become damaged due to excessive bending. If the AC plug cord becomes damaged, consult a PENTAX Service Center.
- Do not short or touch the output terminals of the product while it is still plugged in.
- Unplug the AC plug cord when not using the battery charger.
- Do not plug in the AC plug cord with wet hands. This can cause an electrical shock.
- Do not subject the product to strong impacts or allow it to drop onto a hard surface. This can cause a malfunction.
- Do not use the battery charger to charge batteries other than the ones specified. This can cause overheating or malfunctions.

Care to be Taken During Handling

- Take the Worldwide Service Network that is included in the package. This will be useful if you experience problems abroad.
- When the camera has not been used for a long time, confirm that it is still working properly, particularly prior to taking important pictures (such as at a wedding or during traveling). Contents of the recording cannot be guaranteed if recording, playback or transferring your data to a computer, etc. is not possible due to a malfunction of your camera or recording media (SD Memory Card), etc.
- The lens on this camera is not exchangeable. The lens is not removable.
- Do not clean the product with organic solvents such as thinner or alcohol benzene.
- Places of high temperature and humidity should be avoided. Particular care should be taken regarding vehicles, which can become very hot inside.
- Storing the camera where pesticides and chemicals are handled should be avoided. Remove from case and store in a well-ventilated place to prevent the camera from becoming moldy during storage.

- Do not use the camera where it may come in contact with rain, water or any other liquid because the camera is not weather, water, or liquid resistant.
- Ensure that the camera is not subjected to substantial vibrations, shocks or pressure. Place the camera on a cushion for protection when the camera is subjected to the vibrations of a motorbike, car, or ship, etc.
- The temperature range in which the camera can be used is 0°C to 40°C (32°F to 104°F).
- The liquid crystal display will become black at high temperature but will return to normal when normal temperatures are returned to.
- The response speed of the liquid crystal display becomes slow at low temperatures. This is due to the properties of the liquid crystal and is not a fault.
- Periodic checks are recommended every 1 to 2 years in order to maintain high performance.
- If the camera is subjected to rapid temperature changes, condensation may form on the inside and outside of the camera. Therefore put the camera in a bag or plastic bag, and take the camera out when the difference in temperature has subsided.
- Avoid contact with garbage, dirt, sand, dust, water, toxic gases, salt, etc. as this may cause damage to the camera. If rain or drops of water get onto the camera, please wipe dry.
- Refer to “Precautions When Using an SD Memory Card” (p.19) regarding the SD Memory Card.
- Please do not press forcefully on the LCD monitor. This could cause breakage or malfunction.
- When using a tripod with the camera, be careful not to overtighten the screw in the tripod socket on the camera.

Contents

FOR SAFE USE OF YOUR CAMERA	1
Care to be Taken During Handling	3
Contents	5
Composition of the Operating Manual	9
Checking the Contents of the Package	10
Names of Parts	11
Names of Operating Parts	12
Getting Started	13
Attaching the Strap	13
Powering the Camera	14
Charging the Battery	14
Installing the Battery	15
Using the AC Adapter	17
Installing the SD Memory Card	18
Recorded Pixels and Quality Level for Still Pictures	20
Recorded Pixels and Quality Level for Movies	21
Operating the Camera Parts	23
Using the Grip	23
Opening the LCD Monitor	24
Holding the Camera	25
Using the Flash	26
Turning the Camera On and Off	27
Playback Only Mode	27
Voice Recording Only Mode	28
Initial Settings	29
Setting the Display Language	30
Setting the Date and Time	30
Quick Start	32
Taking Still Pictures	32
Playing Back Still Pictures	34
Playing Back Images	34
Playing Back the Previous or Next Image	34
Rotating the Displayed Image	35
Taking Movies	36
Playing Back Movies	37
Playing Back Movies	37
Common Operations	38
Understanding the Button Functions	38
Capture Mode	38
Playback Mode	40
Voice Recording Mode	42

Using the Menus	43
How to Use the Menus	43
Example of Menu Operation	44
Menu List	46
Taking Still Pictures	48
<hr/>	
Taking Still Pictures	48
Selecting a Still Picture Mode	48
Setting the Functions (Program Mode)	49
Selecting the Picture Mode According to the Shooting Scene (Picture Mode)	50
Using the Zoom	52
Using the Self-Timer	54
Continuous Shooting (Continuous Shooting/High-Speed Continuous Shooting Mode) ...	55
Taking Pictures with Color Filters (Digital Filter Mode)	56
Varying the Settings Automatically (Auto Bracketing)	58
Taking Panorama Pictures (Panorama Assist)	60
Shutter Priority Shooting	62
Aperture Priority Shooting	63
Manual Shooting	64
Using a Wide Angle Conversion Lens (Optional)	65
Displaying Shooting Information in Capture Mode	66
Setting the Still Picture Shooting Functions	67
Shooting and Playback	67
Selecting the Focus Mode	68
Selecting the Flash Mode	70
Adjusting the Flash Intensity	71
Selecting the Recorded Pixels	72
Selecting the Quality Level	73
Adjusting the White Balance	74
Changing the Focusing Area	76
Setting the Light Metering Range to Determine the Exposure (AE Metering)	77
Setting the Sensitivity	78
Setting the Instant Review Time (Instant Review)	79
Setting the Image Sharpness (Sharpness)	80
Setting the Color Saturation (Saturation)	81
Setting the Image Contrast (Contrast)	82
Setting the Exposure (EV Compensation)	83
Saving the Settings (Memory)	84
Taking Movies	86
<hr/>	
Recording Movies	86
Recording Movies	86
Adding a Color Effect to Movies (Color Mode)	88
Taking Time-lapse Movies	89

Setting the Movie Shooting Functions	90
Selecting the Recorded Pixels for Movies	91
Selecting the Quality Level of Movies	92
Selecting the Frame Rate	93
Recording and Playback Sound	94
<hr/>	
Recording Sound (Voice Recording Mode)	94
Playing Back Sound	95
Adding a Voice Memo to Images	96
Recording a Voice Memo	96
Playing Back a Voice Memo	97
Playing Back and Deleting Still Pictures/Movies	98
<hr/>	
Playing Back Still Pictures	98
Playing Back Still Pictures	98
Nine Image Display	98
Zoom Display	99
Displaying Shooting Information in Playback Mode	101
Slideshow	102
Playing Back Movies	103
Playing Back Movies	103
Viewing Still Pictures and Movies on a TV	104
Deleting	105
Deleting Single Images and Sound Files	105
Deleting All Images	107
Protecting Images and Sound Files from Deletion (Protect)	108
Editing and Printing Still Pictures	110
<hr/>	
Editing Still Pictures	110
Changing the Image Size and Quality (Resize)	110
Trimming Images	112
Editing Pictures with Digital Filters	113
Setting the Printing Service (DPOF)	115
Printing Single Images	115
Printing All Images	117
Direct Printing Using PictBridge	118
Connecting the Camera to the Printer	118
Printing Single Images	119
Printing All Images	120
Printing Images Using the DPOF Settings	120
Disconnecting the Camera from the Printer	121
Settings	122
<hr/>	
Camera Settings	122
Formatting an SD Memory Card	122
Changing the Sound Settings	123
Changing the Date and Time	124





Setting the World Time	124
Changing the Display Language	126
Changing the Display Mode	126
Changing the Background Color and Screen Effects	127
Adjusting the Brightness of the LCD Monitor	128
Changing the Video Output Format	129
Changing the USB Connection Mode	130
Setting Sleep Timeout	131
Setting Auto Power Off	131
Registering a Function on the OK Button	132
Resetting to Default Settings (Reset)	133

Appendix

134

List of City Codes	134
Optional Accessories	135
Messages	136
Troubleshooting	138
Main Specifications	140
WARRANTY POLICY	142

The meanings of the symbols used in this operating manual are explained below.

	indicates the reference page number for an explanation of the related operation.
	indicates information that is useful to know.
	indicates precautions to be taken when operating the camera.
 The icons above the title show the Capture modes that can activate the function. Ex. 	Setting the Image Sharpness (Sharpness)

Composition of the Operating Manual

This operating manual contains the following chapters.

1 Getting Started

This chapter explains what you need to do after purchasing the camera before you start taking pictures. Be sure to read it and follow the instructions.

2 Quick Start

This chapter explains the simplest way to take pictures and play back images. Use it if you want to start taking pictures straightaway.

3 Common Operations

This chapter explains common operations such as the functions of the buttons and how to use the menus. For more details, refer to the respective chapters below.

4 Taking Still Pictures

This chapter explains the various ways of taking still pictures and how to set the relevant functions.

5 Taking Movies

This chapter explains the various ways of recording movies and how to set the relevant functions.

6 Recording and Playback Sound

This chapter explains how to record sound only or add sound (a voice memo) to an image, and how to play back voice memos.

7 Playing Back and Deleting Still Pictures/Movies

This chapter explains how to view still pictures and movies on the camera or on a TV and how to delete images from the camera.

8 Editing and Printing Still Pictures

This chapter explains the various ways of printing still pictures and how to edit images with the camera. For instructions on how to print or edit images using a computer, refer to the "PC Connection Manual – Enjoying Your Digital Camera Images On Your PC".

9 Settings

This chapter explains how to set the camera-related functions.

10 Appendix

This chapter explains troubleshooting, and introduces optional accessories.

1

2

3

4

5

6

7

8

9

10

Checking the Contents of the Package

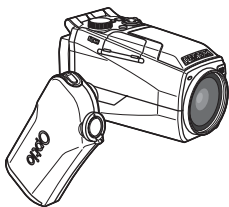

Camera
Optio MX4

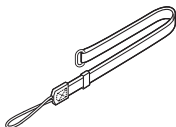

Strap
O-ST17 (*)

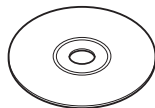

Software (CD-ROM)
S-SW23

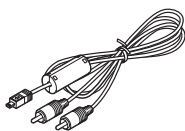

AV cable I-AVC7 (*)

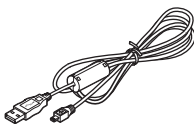

USB cable I-USB17 (*)



Lens cap/Cap holder

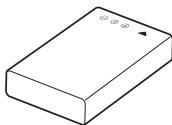

Rechargeable lithium-ion
battery D-LI7 (*)

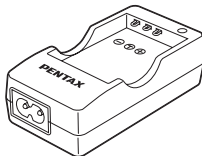

Battery charger
D-BC7 (*)



AC plug cord
D-CO2 (*)



SD Memory Card
(32 MB)



Operating Manual
(this manual)

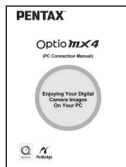

Operating Manual
(PC Connection Manual)

- Items marked with an asterisk (*) are also available as optional accessories. For other optional accessories, refer to "Optional Accessories" (p.135).

Names of Parts

Front

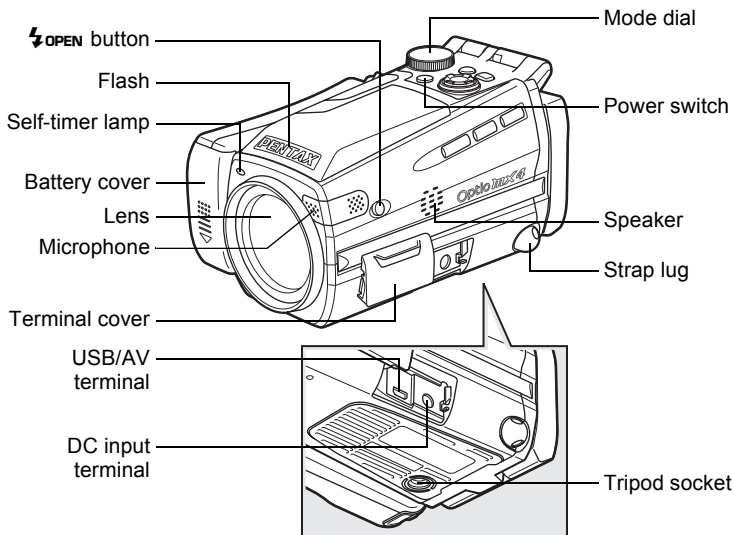

Back

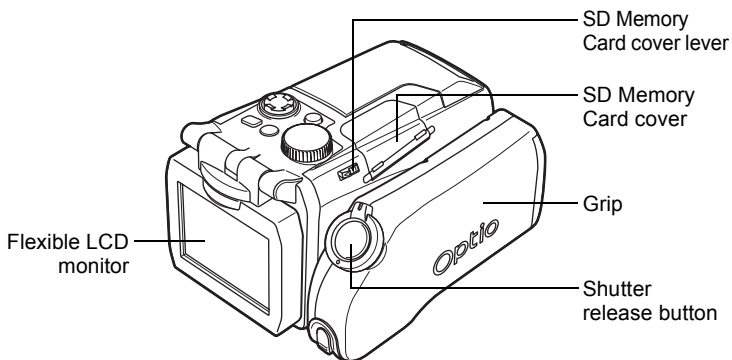

Names of Operating Parts

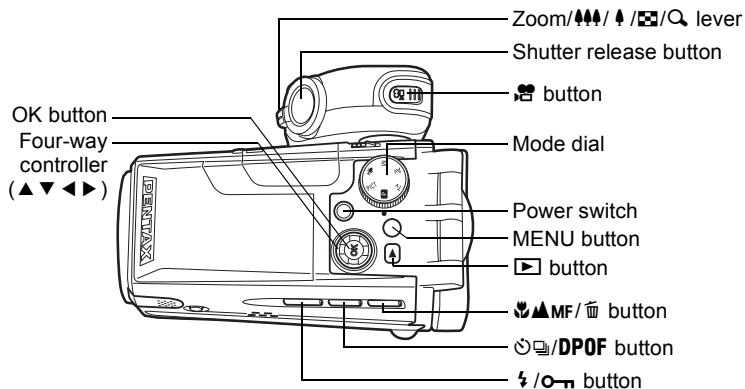

Guide Indications

A guide to available button operations appears on the LCD monitor during operation.

The buttons are indicated as shown below.

Four-way controller (▲)	▲
Four-way controller (▼)	▼
Four-way controller (◀)	◀
Four-way controller (▶)	▶
MENU button	
Shutter release button	
▶ button	

Zoom/⏏/⏏ lever	
When trimming an image	
DPOF button	
⏏ button	
⏏ button	
OK button	
⏏ button	

Attaching the Strap

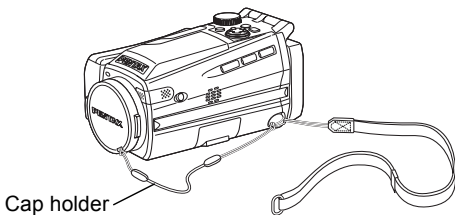

Attach the cap holder to the lens cap and thread the cord onto the camera strap. Remove the lens cap by pressing the tabs on either side of the cap.

1 Attach the strap to the camera.

Pass the narrow end of the strap through the strap lug and pass the other end through the loop. Do not tighten the strap until the cap holder has been attached.

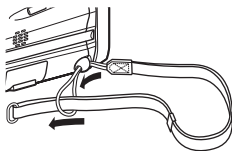

2 Attach the cap holder to the lens cap.

Pass the short end of the cap holder through the hole in the lens cap.



3 Attach the cap holder to the camera strap as shown.

Pass the lens cap through the loop and tighten the cap holder and camera strap.

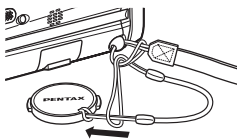

Powering the Camera

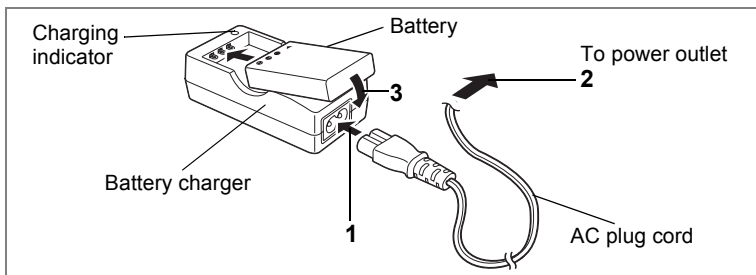

Charging the Battery

When using the camera for the first time or when the [Battery depleted] message is displayed, charge the battery.

- 1 Connect the AC plug cord to the battery charger.**
- 2 Plug the AC plug cord into the power outlet.**
- 3 Place the battery in the charger with the label facing up.**
The charging indicator lights red while the battery is charging and changes to green when charging is completed.
- 4 When charging is completed, remove the battery from the battery charger.**



- The time required for full charge is about 180 minutes maximum. The appropriate ambient temperature range for charging the battery is 0°C-40°C (32°F to 104°F).
- The charging time may vary depending on the ambient temperature and charging conditions.
- When the battery reaches the end of its service life, the time that the camera can be operated becomes shorter even when the battery is fully charged. In this event, replace the battery.



- Always charge the battery after purchasing or when it has not been used for a long time.
- Use the Battery charger D-BC7 to charge the rechargeable Lithium-ion battery D-LI7 only as the charger may overheat or be damaged.
- If the battery is inserted correctly but the charging indicator fails to light, the battery may be faulty. Replace with a new battery.

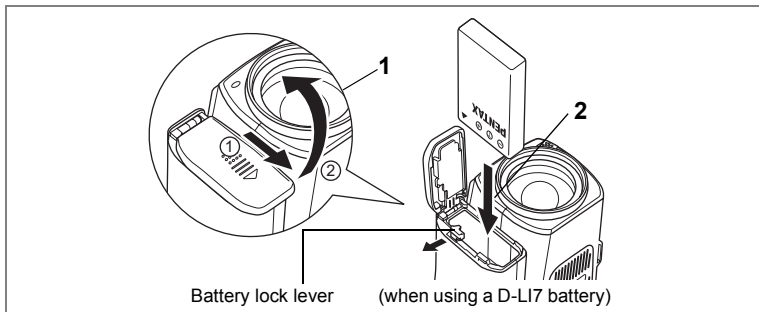

Installing the Battery

Insert the battery in the camera. Use one D-LI7 rechargeable lithium-ion battery.



AA batteries or AA rechargeable batteries cannot be used in this camera.

- 1 Open the battery cover on the end of the grip.**
Slide the battery cover in the direction indicated by the arrow ① and flip the cover open ②.
- 2 Insert the battery with the ▲ symbol facing toward the battery lock lever.**
Push the battery in until the battery lock lever clicks.
- 3 Close the battery cover and slide it back into place to lock it.**
Remove the battery by pressing the battery lock lever outward to release the lock.



- If you intend to use the camera continuously for a long period, use of the AC adapter D-AC7 (optional) is recommended. (p.17)
- The D-LI7 lithium-ion battery cannot be recharged in the camera.
- CR-V3 battery can be used but camera performance may deteriorate at low temperatures. Use the D-LI7 lithium-ion battery when using the camera at low temperatures.



- Insert the battery correctly. If the battery is incorrectly oriented, malfunction may result.
- Do not open the battery cover or remove the battery when the camera is turned on.
- If you do not intend to use the camera for a long time, remove the battery to avoid the risk of leakage.
- If the camera is left without the battery for a long time, the date and time may be reset. If this happens, follow the procedure in “Setting the Date and Time” (p.30).

• Image Storage Capacity, Recording Time and Playback Time (at 23°C, LCD monitor on with fully charged D-LI7 battery)

Image Storage Capacity (using the flash for 50% of shots)	Recording Time	Playback Time
Approx. 180 pictures	Approx. 80 min.	Approx. 200 min.



The still picture storage capacity is based on measuring conditions in accordance with CIPA standards and the movie recording time and playback time are based on PENTAX measuring conditions. Some deviation from the above figures may occur in actual use depending on shooting mode and shooting conditions.



- In general, battery performance temporarily deteriorates as the temperature decreases. When using the camera in a cold environment, keep it warm by putting it in your pocket or inside your coat. Battery performance that has deteriorated due to low temperature will be restored when the battery is returned to room temperature.
- Be sure to take a spare battery with you when traveling abroad or to a cold region, or if you intend to take a lot of pictures.

• Battery Level Indicator

You can check the battery level by the  symbol on the LCD monitor.

	(lit green)	: Adequate power remains.
↓		
	(lit yellow)	: Battery is running very low.
↓		
	(lit red)	: Battery is exhausted.
↓		
[Battery depleted]		: The camera will turn off after this message appears.

• Recycling Batteries



This symbol indicates that the battery is recyclable. Cover the terminals with insulating tape and take the battery to a store displaying this symbol.

Li-ion

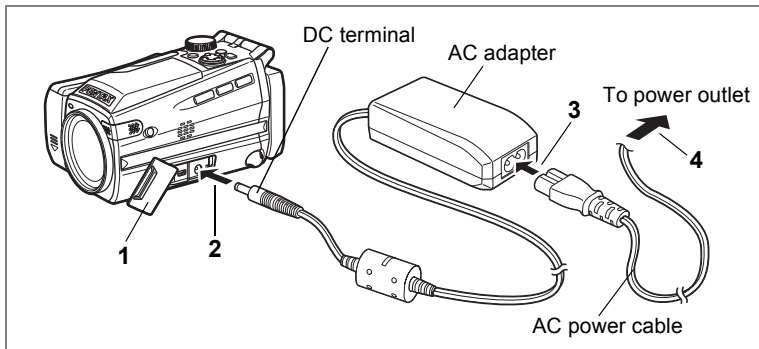

Using the AC Adapter

If you intend to use the camera for a long time or connect the camera to a PC, use of the AC adapter D-AC7 (optional) is recommended.

- 1 Make sure that the camera is turned off and open the terminal cover.**
- 2 Connect the DC terminal on the AC adapter to the DC input terminal on the camera.**
- 3 Connect the AC power cable to the AC adapter.**
- 4 Plug the AC power cable into the power outlet.**



- Make sure that the camera is turned off when connecting or disconnecting the AC adapter.
- Make sure that the AC power cable and connecting cable are inserted securely. The data may be lost if the cable becomes disconnected while you are taking pictures.
- To avoid the risk of fire or electric shock when using the AC adapter, be sure to read "FOR SAFE USE OF YOUR CAMERA" (p.1) before using the adapter.
- Be sure to read the operation manual accompanying the AC adapter D-AC7 before using the adapter.
- The battery inside the camera cannot be charged by connecting the AC adapter.

Installing the SD Memory Card

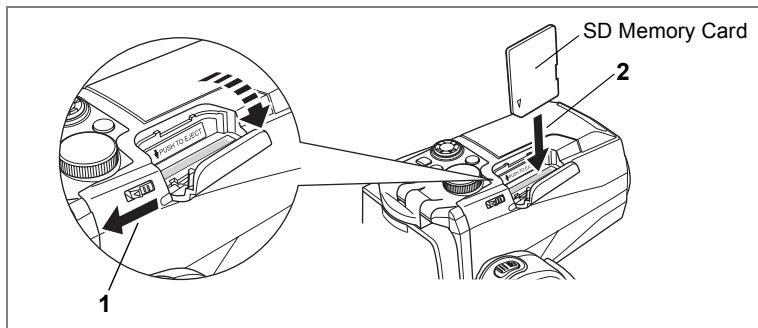

This camera uses an SD Memory Card to record captured images. Make sure that the camera is turned off before inserting or removing the SD Memory Card.

1 Push the card cover lever toward the LCD monitor.

The card cover opens.

2 Insert the SD Memory Card so the label is on the grip side and push the card in until it clicks.

3 Close the card cover.

To remove the card, press the card in to eject it and pull it out.



- The image storage capacity varies depending on the capacity of the SD Memory Card and the selected number of recorded pixels and quality level. (p.20)
- The power switch lamp blinks while the SD Memory Card is being accessed (data is being recorded or accessed).
- Use a high-speed type SD Memory Card (10MB/S) for recording movies. If a standard-speed card (2MB/S) is used, [Stop] may appear on the LCD monitor and recording may be terminated.



Be sure to format unused cards or cards that have been used on another camera. Refer to “Formatting an SD Memory Card” (p.122) for instructions on formatting.

Precautions When Using an SD Memory Card

- The SD Memory Card is equipped with a write-protect switch. Setting the switch to LOCK protects the existing data by prohibiting recording of new data, deletion of existing data or formatting of the card.

 appears on the LCD monitor when the card is write-protected.

Write-protect switch

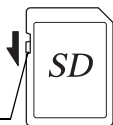

- Care should be taken if you remove the SD Memory Card immediately after using the camera, as the card may be hot.
- Do not remove the SD Memory Card or turn the camera off while data is being recorded on the card, images or sound are being played back, or the camera is connected to a PC with the USB cable, as this may cause the data to be lost or the card to be damaged.
- Do not bend the SD Memory Card or subject it to violent impact. Keep it away from water and store away from high temperature.
- Be sure to format unused cards or cards that have been used on another camera. Refer to "Formatting an SD Memory Card" (p.122) for instructions on formatting.
- Do not remove the SD Memory Card during formatting as this may damage the card and render it unusable.
- The data on the SD Memory Card may be deleted in the following circumstances. PENTAX does not accept any liability for data that is deleted
 - (1) when the SD Memory Card is mishandled by the user.
 - (2) when the SD Memory Card is exposed to static electricity or electrical interference.
 - (3) when the card has not been used for a long time.
 - (4) when the card is ejected, the AC adapter is disconnected or the battery is removed while the data on the card is being recorded or accessed.
- The SD Memory Card has a limited service life. If it is not used for a long time, the data on the card may become unreadable. Be sure to make a backup of important data on a PC.
- Avoid using or storing the card where it may be exposed to static electricity or electrical interference.
- Avoid using or storing the card in direct sunlight or where it may be exposed to rapid changes in temperature or to condensation.
- When using an SD Memory Card with a slow recording speed, recording may stop while you are taking movies even when there is adequate space in the memory, or shooting and playback may take a long time.
- For information on compatible memory cards, visit the PENTAX website or contact your nearest PENTAX customer service center.

Recorded Pixels and Quality Level for Still Pictures

Choose the number of recorded pixels and quality level best suited to your purpose.

Higher quality levels and numbers of recorded pixels produce clearer images for printing, but the resulting increase in data volume reduces the total number of pictures that can be taken.

Choose the appropriate number of recorded pixels and quality level for still pictures on the [📷 Rec. Mode] menu.

Selecting the Recorded Pixels 📄p.72

Selecting the Quality Level 📄p.73

● Appropriate Number of Recorded Pixels According to Use

2304 (2304×1728)	Suitable for printing on A4 paper
1600 (1600×1200)	Suitable for printing on paper slightly larger than a postcard
1024 (1024×768)	Suitable for printing on postcards
640 (640×480)	Suitable for attaching to e-mails or creating websites

The default setting is **2304×1728**.

● Appropriate Quality Level According to Use

★★★ (Best)	Lowest compression rate. Suitable for photo prints.
★★ (Better)	Standard compression rate. Suitable for viewing the image on a computer screen.
★ (Good)	Highest compression rate. Suitable for attaching to e-mails or creating websites.

The default setting is **Better**.

● Recorded Pixels, Quality Level and Recordable Images

Quality level Recorded pixels	★★★ Best	★★ Better	★ Good
2304 (2304×1728)	24 pictures	47 pictures	69 pictures
1600 (1600×1200)	51 pictures	89 pictures	123 pictures
1024 (1024×768)	112 pictures	202 pictures	257 pictures
640 (640×480)	241 pictures	386 pictures	483 pictures

- The above table shows the approximate number of images when using a 64MB SD Memory Card.
- The above figures are based on standard shooting conditions specified by PENTAX and may vary depending on the subject, shooting conditions, capture mode, SD Memory Card, etc.

Recorded Pixels and Quality Level for Movies

Choose the number of recorded pixels and quality level best suited to your purpose.

The number of recorded pixels indicates the image resolution. Larger sizes produce clearer images, but results in larger filesizes.

The frame rate indicates the number of images that are displayed per second. Higher numbers produce smoother motion, but also results in larger filesizes.

Choose the appropriate number of recorded pixels and quality level for movies on the [ Rec. Mode] menu.

Selecting the Recorded Pixels for Movies  p.91

Selecting the Quality Level for Movies  p.92

Selecting the Frame Rate  p.93

● Appropriate Number of Recorded Pixels According to Use

640 (640×480)	VGA size. Produces high quality movies for viewing on a TV. Large filesize.
320 (320×240)	Suitable for viewing on a PC.
160 (160×120)	Low quality, but small filesize.

The default setting is **640×480**.

● Appropriate Quality Level According to Use

★★★ (Best)	Produces high quality movies for viewing on a TV.
★★ (Better)	Suitable for sending by high-speed Internet circuit.
★ (Good)	Suitable for attaching to e-mails.

The default setting is **Best**.

● Appropriate Frame Rate According to Use (frames/sec.)

30fps	Produces high quality images for viewing on a TV.
15fps	Suitable for viewing on a PC or on the camera.

The default setting is **30 frames/sec. (fps)**.

● Recorded Pixels, Quality Level and Recording Time

Frame rate: 30fps (15fps)

Quality level Recorded pixels	★★★ Best	★★ Better	★ Good	Sound
640 (640×480)	2.5 min. (5 min.)	4 min. (7 min.)	5 min. (9 min.)	4 hr. 22 min.
320 (320×240)	6 min. (11 min.)	9 min. (16 min.)	16 min. (25 min.)	
160 (160×120)	16 min. (25 min.)	20 min. (31 min.)	31 min. (42 min.)	

- The above table shows the approximate recording time when using a 64MB SD Memory Card.
- The above table is based on standard shooting conditions specified by PENTAX and may vary depending on the subject, shooting conditions, SD Memory Card, etc.

Operating the Camera Parts

The following is an explanation of how to operate the camera parts.

Using the Grip

Pull the grip out from the camera and rotate it in the direction indicated by the arrow.

Adjust the grip to a comfortable position for holding the camera (about 120°).

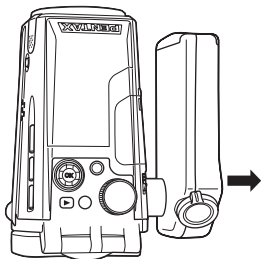

Take hold of the grip near the hinge and extend it.

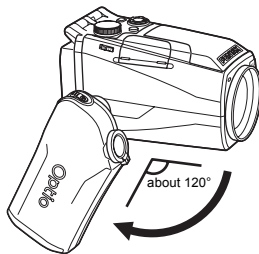

Rotate the grip to the desired position.



You can rotate the grip to a maximum of 180 degrees to the lens. Do not apply excessive force to the grip.



- You can use the camera without extending the grip.
- For greater stability, leave the grip unextended when attaching the camera to a tripod.

Opening the LCD Monitor

You can swivel the LCD monitor 210 degrees vertically and 180 degrees horizontally to ensure easy viewing from different angles.



Do not apply excessive force when swiveling the LCD monitor.

Lift

Open the LCD monitor from the bottom.

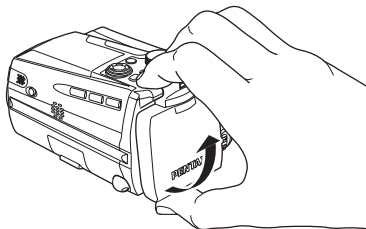

Swivel

Swivel the LCD monitor anticlockwise.

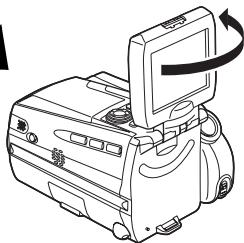

Lower

Lower the LCD monitor into the viewing position.

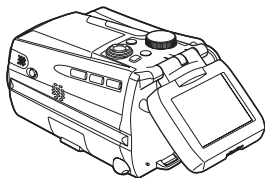
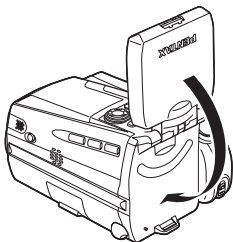

- When you aim the LCD monitor at yourself to take a picture of yourself, the image you see in the LCD monitor will be a mirror image, but the resulting picture will be the view seen through the lens.
- To protect the LCD monitor when the camera is not in use, return the LCD monitor to the position it was in when the camera was purchased.

Holding the Camera

Holding the camera in your right hand by the grip, operate the shutter release button and the Zoom/▲▲▲/▲ lever with your index finger and the  button with your thumb.

To prevent camera shake when using the zoom or taking movies, hold the camera steady with your left hand. Position the LCD monitor at an angle of 45 degrees for easy viewing.



- When recording movies, sound is recorded at the same time. Be careful not to cover the microphone or the holes at the side of the microphone with your finger.
- You are recommended to use a tripod to prevent camera shake when taking pictures at a high magnification rate.

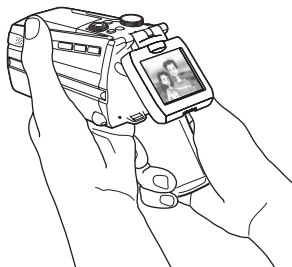
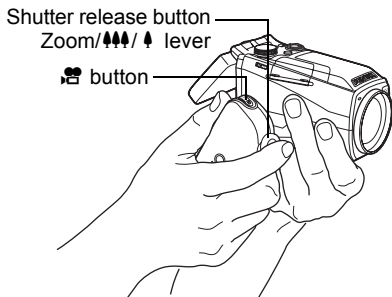

Using the Flash

1

Getting Started

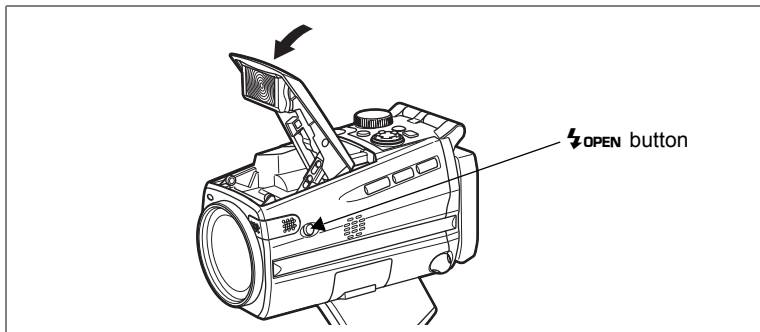

1 Press the **⚡OPEN** button on the side of the camera.

The flash pops up.

Press the area around the PENTAX logo on the cover softly to close the flash.

Turning the Camera On and Off

1

Getting Started

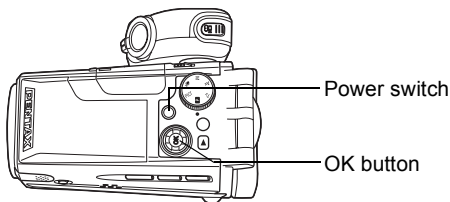

1 Press the power switch.

The camera turns on and the power switch lights green.

The shooting mode icon and name appear for one second.

If the Initial Settings screen or Date Adjust screen appears when you turn the camera on, follow the procedure on page 29 to set the display language and/or current date and time.



2 Press the power switch again.

The camera turns off and the power switch turns light off.

Taking Still Pictures p.48

Recording and Playback p.67

Playback Only Mode

Use this mode when you want to play back pictures one after another. Pressing the shutter release button does not change the mode to the Capture mode.

1 Press the power switch while pressing the button.

The camera turns on in Playback Only mode.



To switch from Playback Only mode to Capture mode, turn the camera off, then turn it on again.

Playing Back Still Pictures p.98

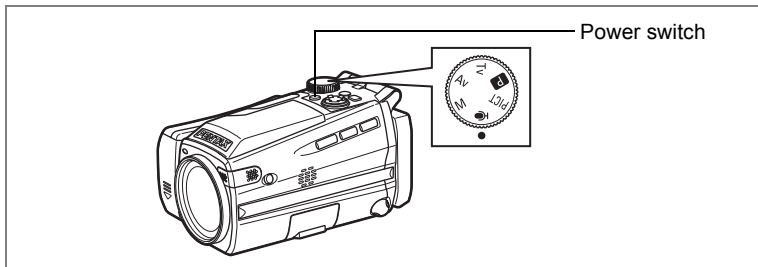

Voice Recording Only Mode

This mode lets you use the camera as a voice recorder. Voice Recording Only mode is exclusively for recording sound; you cannot take still pictures or movies in this mode.

1 Set the mode dial to and press the power switch.

The camera turns on in Voice Recording Only mode.



To switch to capture status, set the mode dial to any mode other than .

Recording Sound  p.94

Voice Recording Mode  p.42

Initial Settings

1

Getting Started

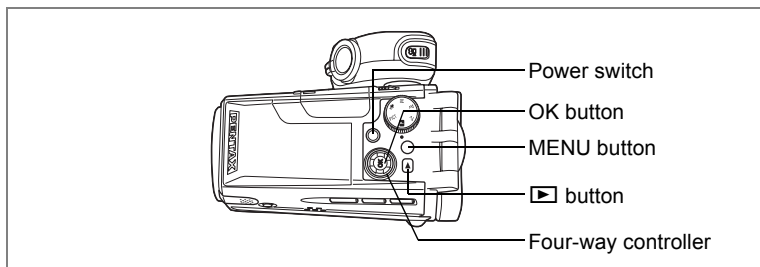

If the Initial Settings screen or Date Adjust screen appears when you turn the camera on, follow the procedure below to set the display language and/or current date and time.

If the Initial Settings screen appears

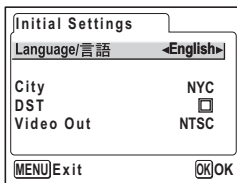

☞ p.30 “Setting the Display Language” “Setting the Date and Time”

If the Date Adjust screen appears

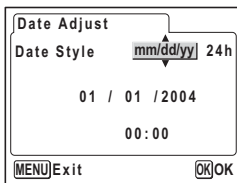

☞ p.30 “Setting the Date and Time”

If neither screen appears, setting is not required.

Setting the Display Language

You can choose the language in which the menus, error messages, etc. are displayed from the following: English, French, German, Spanish, Italian, Russian, Chinese, Korean and Japanese.

- Use the four-way controller (◀▶) to choose the display language.**
The default setting is English.
- Press the four-way controller (▼).**
The frame moves to [City].
- Use the four-way controller (◀▶) to choose the desired city (Home Town).**
- Press the four-way controller (▼).**
The frame moves to [DST] (Daylight Saving Time).
- Use the four-way controller (◀▶) to select (On) or (Off).**
- Press the four-way controller (▼).**
The frame moves to [Video Out].
- Use the four-way controller (◀▶) to choose [NTSC] or [PAL].**
- Press the OK button.**
The Date Adjust screen appears.

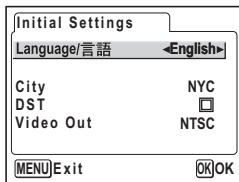

Setting the Date and Time

Set the current date and time and the display style.

- Use the four-way controller (▲▼) to choose the date and time display style.**
- Press the four-way controller (▶).**
▲ and ▼ appear above and below [24h].
- Use the four-way controller (▲▼) to select [24h] (24-hour display) or [12h] (12-hour display).**

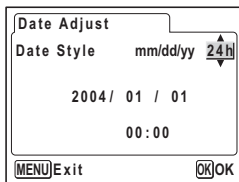
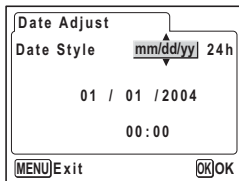

4 Press the four-way controller (▶).

▲ and ▼ appear above and below the month.

5 Use the four-way controller (▲▼) to change the month.

6 Press the four-way controller (▶).

▲ and ▼ appear above and below the day.

7 Use the four-way controller (▲▼) to change the day and press the four-way controller (▶).

▲ and ▼ appear above and below the year.

8 Repeat Step 7 to change the [year], [hour] and [minutes].

If you select [12h] in Step 3, the setting switches between am and pm corresponding to the time.

9 Press the OK button when you have finished the settings.

The camera is ready to take pictures.

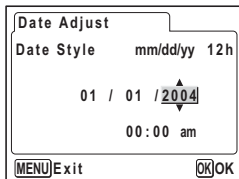
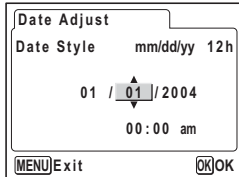
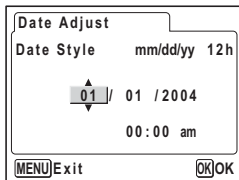

- When you finish the settings and press the OK button, the camera clock is reset to 00 seconds.
- To set the exact time, press the OK button when the time signal (on the TV, radio, etc.) reaches 00 seconds.



- When the Initial Settings or Date Adjust screen is displayed, you can cancel the setting operation and switch to Capture mode by pressing the MENU button. In this case, the screen will appear next time you turn the camera on.
- You can change the settings after they have been made. Refer to “Changing the Date and Time” (p.124).

Taking Still Pictures

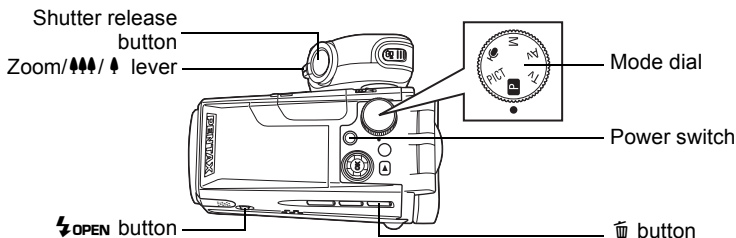

The standard procedure for taking still pictures is described below. If the flash has been opened, it will fire automatically depending on the light conditions.

- 1 Pull the grip out and rotate it into position.**
- 2 Open the LCD monitor.**
- 3 Press the power switch.**
The camera turns on.
- 4 Set the mode dial to **P**.**
- 5 Check the image on the LCD monitor.**

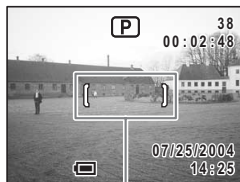

Focus frame

The focus frame in the middle of the LCD monitor indicates the zone of automatic focusing. You can change the captured area by pressing the Zoom/▲▲▲/▲ lever to the right or left.

▲ : enlarges the subject.

▲▲▲ : enlarges the area captured by the camera.

- 6 Press the shutter release button halfway.**
- 7 Press the shutter release button fully.**

The focus frame turns green if the subject is in focus.

The picture is taken.

The image appears on the LCD monitor for one second (Instant Review) and is recorded on the SD Memory Card.



You are recommended to use a tripod to prevent camera shake when taking pictures at a high magnification rate.

Using the Shutter Release Button

The shutter release button works in a two-step action.

Press halfway

The focus and exposure are locked when the shutter release button is pressed lightly (halfway). The shutter speed and aperture settings only appear on the LCD monitor when the shutter release button is pressed halfway (when the mode dial is set to **P** or **PICT**). The focus frame lights green at the focusing position if the subject is in focus. The frame does not appear if the subject is out of focus.

Press fully

The picture is taken.

[Poor focusing conditions]

The camera may not be able to focus under the following conditions. In this case, lock the focus on an object the same distance away as the subject (by pressing the shutter release button halfway), then aim the camera at your subject and press the shutter release button fully.

- Objects that lack contrast such as a blue sky or white wall
- Dark places or objects, or conditions that prevent light being reflected back
- Horizontal lines or intricate patterns
- Fast moving objects
- When there is an object in the foreground and an object in the background in the same picture
- Strongly reflected light or strong backlighting (bright background)

Instant Review

The image appears on the LCD monitor for one second (Instant Review) immediately after it is captured.

You can change the Instant Review time. (p.79)

Playing Back Still Pictures

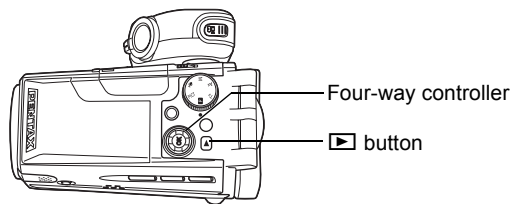

Playing Back Images

You can display the still pictures you have taken.

- 1 Press the ▶ button after taking a picture.**

The image appears on the LCD monitor.



For instructions on how to view images on a computer, refer to the "PC Connection Manual – Enjoying Your Digital Camera Images On Your PC".

Playing Back the Previous or Next Image

Still pictures can be played back one at a time, proceeding either forward or backward.

- 1 Press the ▶ button after taking a picture.**

The image appears on the LCD monitor.

- 2 Press the four-way controller (◀▶).**



displays the previous image.



displays the next image.

Rotating the Displayed Image

1 Press the button after taking a picture.

The image appears on the LCD monitor.

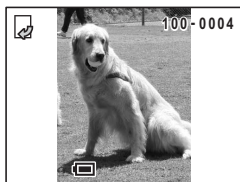

2 Press the four-way controller ()

The image is rotated 90 degrees clockwise each time the button is pressed.





The zoom display and nine-image display functions cannot be used with rotated images, nor can DPOF or delete/protect settings be made.

Deleting the Displayed Image

You can delete the image displayed on the LCD monitor by pressing the  button, using the four-way controller () to select [Delete] and pressing the OK button. (p.105)

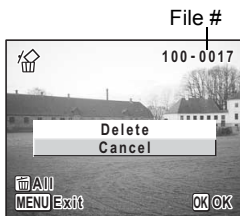
Press the shutter release button halfway to return to shooting status.



- The last picture taken appears on the LCD monitor when you switch to the Playback mode.
- You can enlarge the image by pressing the Zoom//Q lever. (p.99)
- If there are no images stored, the [No image & sound] message appears.

Taking Movies

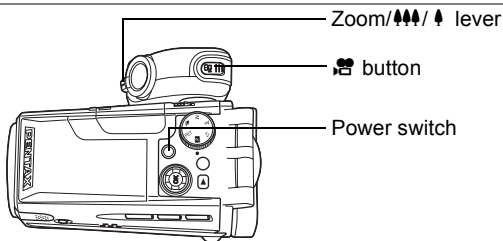

The standard procedure for recording movies is described below.

1 Pull the grip out and rotate it into position.

2 Open the LCD monitor.

3 Press the power switch.

The camera turns on.

4 Press the  button.

Recording starts.

You can change the captured area by pressing the Zoom/▲▲▲/▲ lever to the right or left.

Press the lever gently to change the captured area slowly and press it all the way to change the area quickly.

▲ : enlarges the subject.

▲▲▲ : enlarges the captured area.

5 Press the  button again.

Recording stops.



Using the Zoom p.52



- You are recommended to use a tripod to prevent camera shake when taking pictures at a high magnification rate.
- The self-timer lamp lights during movie recording to show that recording is in process.
- The LCD monitor swivel mechanism ( p.24) does not function during movie recording.
- The zoom bar does not appear on the LCD monitor when zooming in or out during movie recording.
- When the shutter release button is pressed during movie recording, the focus is locked.
- Movie is recorded magnified about 1.2 times as large as still pictures.

Playing Back Movies

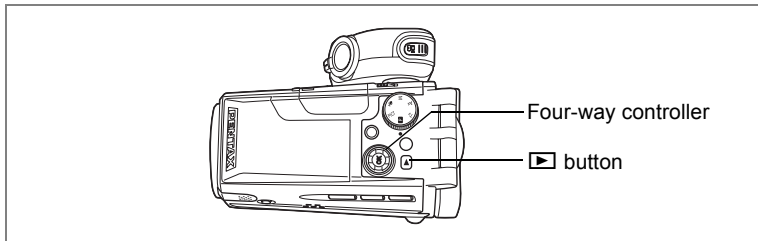

Playing Back Movies

You can play back the movies you have taken.

- 1 Press the ▶ button after taking a movie.**

The image appears on the LCD monitor.
The first frame appears on the monitor and
▶ appears on the movie.

- 2 Press the four-way controller (▲).**

Playback starts.

Press the four-way controller (▼) to stop playback.



You can also play back movies on a TV. (p.104) For instructions on how to play back movies on a computer, refer to the "PC Connection Manual – Enjoying Your Digital Camera Images On Your PC".

Understanding the Button Functions

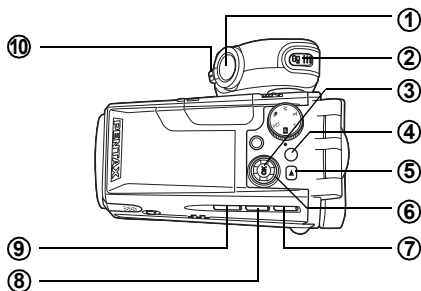

Capture Mode

- ① **Shutter release button**
Starts taking still pictures. (☞p.32)
- ② **🎥 button**
Starts recording movies. When pressed again, stops recording. (☞p.86)
- ③ **OK button**
Changes the information displayed on the LCD monitor. (☞p.66)
Displays the Digital Filter options screen. (☞p.56)
Saves your current menu selection if you have a menu open.
- ④ **MENU button**
Displays the [📷 Rec. Mode], [🎥 Movie Mode], [▶ Playback] and [⚙️ Set-up] menus. (☞p.43)
- ⑤ **▶ button**
Switches to the Playback mode. (☞p.34)

⑥ Four-way controller

PICT mode:

(▼) Selects the Picture mode. (☞p.50)

(◀▶) Adjusts the exposure. (☞p.83)

P mode:

(◀▶) Adjusts the exposure. (☞p.83)

Tv mode:

(▲▼) Adjusts the shutter speed. (☞p.62)

(◀▶) Adjusts the exposure. (☞p.83)

Av mode:

(▲▼) Adjusts the aperture. (☞p.63)

(◀▶) Adjusts the exposure. (☞p.83)

M mode:

(▲▼) Adjusts the aperture. (☞p.64)

(◀▶) Adjusts the shutter speed. (☞p.64)

⑦ MF button

Changes the shooting mode in the following sequence. (☞p.68)

Macro mode, Super Macro mode, Infinity-Landscape mode, Manual Focus mode

⑧ button

Selects self-timer mode, continuous shooting mode and auto bracketing mode. (☞p.54 – p.59)

⑨ button

Changes the flash mode. (☞p.70)

⑩ Zoom/ lever

Changes the shooting area. (☞p.52)

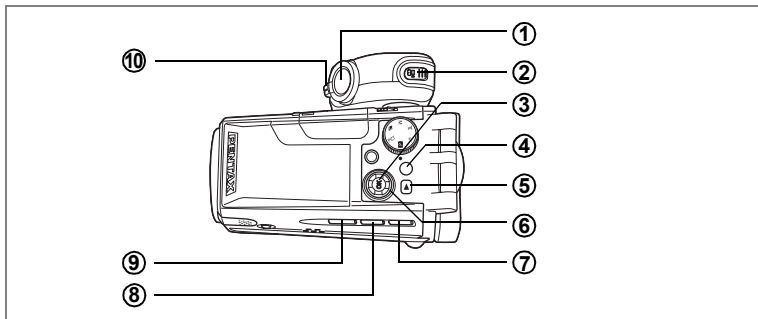

Playback Mode

- ① **Shutter release button**
Stops playback and switches to the Capture mode. (☞p.32)
- ② **▶ button**
Stops playback and switches to the Capture mode. (☞p.32)
- ③ **OK button**
Changes the information displayed on the LCD monitor. (☞p.101)
Saves your current menu selection. (☞p.43)
- ④ **MENU button**
Displays the [📷 Rec. Mode], [🎥 Movie Mode], [▶ Playback] and [⚙️ Set-up] menus. (☞p.43)
- ⑤ **▶ button**
Stops playback and switches to the Capture mode. (☞p.32)
- ⑥ **Four-way controller**
 - (▲) Plays back and pauses a movie. (☞p.103)
Records or plays back a voice memo for a still picture. (☞p.96, p.97)
 - (◀▶) Displays the previous or next image. (☞p.34)
 - (▼) Rotates the still picture. (☞p.35)
Stops a movie during playback. (☞p.103)
- ⑦ **🗑️ button**
Deletes the image displayed on the LCD monitor. (☞p.105)

⑧ **DPOF button**

Sets the items for printing images. (☞p.115)

⑨ **🔒 button**

Protects images from deletion. (☞p.108)

⑩ **Zoom/📷/🔍 lever**

Press toward 📷 during normal playback to display nine images at once. (☞p.98)

Press toward 🔍 for zoom display and to change the size of the image displayed on the LCD monitor. (☞p.99)



Pressing the shutter release button, the 📷 button or the ▶ button does not change the mode to the Capture mode when the camera was turned on in Playback Only mode. To switch to the Capture mode, turn the camera off and then turn it on again.

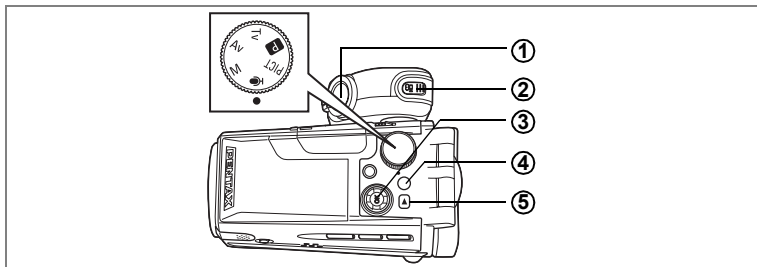

Voice Recording Mode

① Shutter release button

When pressed, starts recording, and when pressed again, stops recording. When pressed for more than one second, recording continues for as long as the button is held down and stops when the button is released.

② button

When pressed during recording, an index can be added to the sound being recorded. (☞ p.94)

③ Four-way controller (in Playback Only mode)

(▲) Starts playback. When pressed again, pauses playback. (☞ p.95)

(◀▶) Selects a sound file before playback.

Performs the following operations during playback.

If there are no recorded indexes:

When (◀) is pressed during playback, rewinds five seconds.

When (▶) is pressed during playback, advances five seconds.

If there are recorded indexes:

When (◀) is pressed during playback, returns to the previous index.

When (▶) is pressed during playback, goes to the next index.

④ MENU button

Displays the [📷 Rec. Mode], [🎥 Movie Mode], [▶ Playback] and [⚙️ Set-up] menus. (☞ p.43)

⑤ button

Switches to the Playback mode. When pressed again, returns to Voice Recording mode. (☞ p.95)

Using the Menu

When you press the MENU button, a menu appears on the LCD monitor. The menu varies depending on the camera mode. You can set functions, save the settings and change the camera settings on these menus.

How to Use the Menu

When you are making settings from a menu, a guide to operation appears on the LCD monitor.

Ex.) To set the [Quality Level] on the [Rec. Mode] menu

- 1 Press the MENU button in Capture mode.**

The [Rec. Mode] menu appears.

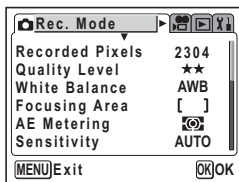

- 2 Press the four-way controller (▼).**

You can choose an item.

- 3 Press the four-way controller (▼).**

The frame moves to [Quality Level].

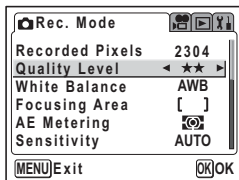

- 4 Use the four-way controller (◀▶) to change the setting.**

The quality changes each time the four-way controller is pressed.

- 5 Press the OK button or the shutter release button.**

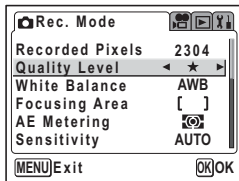

The setting is saved and the screen returns to capture status.

Caution

Even after pressing the OK button or the shutter release button to exit the menu, if you turn the camera off incorrectly (such as by removing the battery while the camera is turned on), any changes you have made to the settings will not be saved.

Example of Menu Operation

Capture mode



MENU

[📷 Rec. Mode] Menu

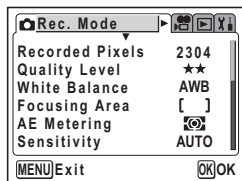

[📹 Movie Mode] menu

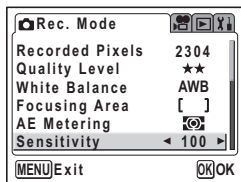
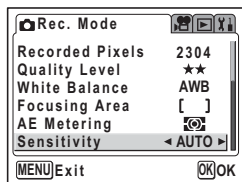
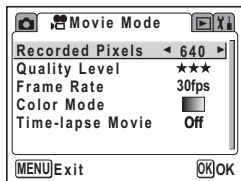
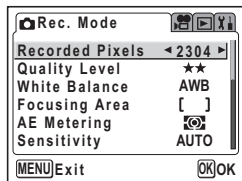
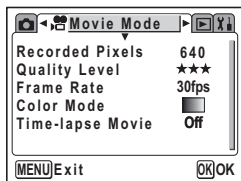

To the next screen

3

Common Operations

Playback mode



[▶ Playback] Menu

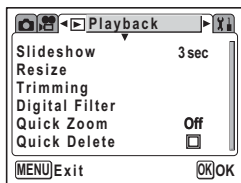

[⌘ Set-up] Menu

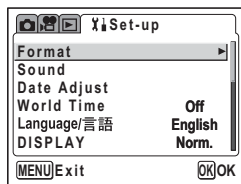
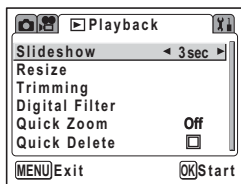
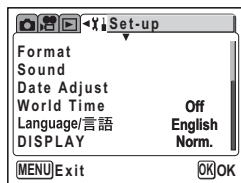

To the next screen



- The [📷 Rec. Mode] menu appears when you press the MENU button in Capture mode, and the [▶ Playback] menu appears when you press the MENU button in Playback mode.
- You can change the menu displayed on the LCD monitor to the [📷 Rec. Mode], [🎬 Movie Mode], [▶ Playback] or [⌘ Set-up] menu by pressing the zoom lever.

Menu List







Rec. Mode] Menu

This menu shows the functions related to taking still pictures. Some of the functions are also used for taking movies.

Yes.....Adjustable

NoAny changes made are invalid. You can change the setting on the menu, but any changes you make are invalid in actual operation.

—Set on the [ Movie Mode] menu.

Item	Description	Default Setting	PICT	 TV Av M		Page
Recorded Pixels	For selecting the number of pixels	2304 (2304×1728)	Yes	Yes	—	p.72
Quality Level	For selecting the image compression rate	★★ (Better)	Yes	Yes	—	p.73
White Balance	For adjusting the color balance according to the light conditions	AWB (Auto)	No	Yes	Yes	p.74
Focusing Area	For changing the area of the autofocus	[] (Multiple)	Yes	Yes	No	p.76
AE Metering	For setting the metering method to determine the exposure	 (Multi-segment)	Yes	Yes	Yes	p.77
Sensitivity	For setting the sensitivity	AUTO	Yes	Yes	Yes	p.78
Flash Exp. Comp.	For adjusting the flash intensity	0	Yes	Yes	No	p.71
Digital Filter	For taking pictures with a color filter effect	No digital filter	Not selectable	Yes	—	p.56
Digital Zoom	For taking digital zoom pictures	×4	Yes	Yes	Yes	p.52
Instant Review	For setting the Instant Review time	1 sec	Yes	Yes	No	p.79
Memory	For saving the shooting function settings when the camera is turned off	*	Yes	Yes	Yes	p.84
Sharpness	For setting the sharpness	 (Normal)	No	Yes	Yes	p.80
Saturation	For setting the saturation	 (Normal)	No	Yes	Yes	p.81
Contrast	For setting the contrast	 (Normal)	No	Yes	Yes	p.82

* Only the flash and digital zoom settings and the file number are saved.

[Movie Mode] menu

This menu is only for movies.

Item	Description	Default Setting	Page
Recorded Pixels	For selecting the number of pixels	640 (640×480)	p.91
Quality Level	For selecting the quality level for movies	★★★ (Best)	p.92
Frame Rate	For selecting the number of frames (still pictures) per second	30fps	p.93
Color Mode	For selecting a color filter when taking a movie	Color	p.88
Time-lapse Movie	For setting a delayed frame rate to give the impression of speeded up action when played back	Off	p.89

[Playback] Menu

Item	Description	Page
Slideshow	For playing back recorded images one after another	p.102
Resize	For changing the size of images	p.110
Trimming	For trimming images	p.112
Digital Filter	For creating a color filter effect using red, blue, green filters etc.	p.113
Quick Zoom	For playing back images at the set zoom size by pressing the Zoom/  lever only once	p.100
Quick Delete	For displaying the Delete screen with [Delete] highlighted when [On] is selected	p.106

[Set-up] Menu

Item	Description	Page
Format	For formatting SD Memory Cards	p.122
Sound	For adjusting the playback volume and settings of the start-up sound, shutter sound, key operation sound, focus sound and self-timer sound	p.123
Date Adjust	For adjusting the date, time and date style	p.124
World Time	For setting the world time	p.124
Language/言語	For changing the language in which menus and messages appear	p.126
DISPLAY	For changing the information displayed on the LCD monitor	p.126
Screen Setting	For selecting the background color and screen effects	p.127
Brightness Level	For changing the brightness of the LCD monitor	p.128
Video Out	For setting the video output format	p.129
USB Connection	For changing the USB connection mode	p.130
Sleep Timeout	For setting the power-saving function	p.131
Auto Power Off	For turning off the power automatically after a fixed time	p.131
OK Button	For registering a function on the OK button during capture/playback	p.132
Reset	For returning the settings other than the date adjust, language/言語 and world time to defaults	p.133

Taking Still Pictures

Selecting a Still Picture Mode

There are various ways of capturing images, from modes where the camera automatically sets the shooting functions to obtain the best pictures, to modes where settings are made manually to achieve a particular effect.

Capture Modes

PICT	Picture mode	There are ten Picture modes to choose from. The camera selects the optimal exposure, white balance, etc. according to the shooting conditions. This mode lets you take pictures in a variety of situations.	p.50
P	Program mode	This is the basic picture-taking mode. It offers a wide range of camera functions for you to enjoy.	p.49
Tv	Shutter Priority mode	This mode lets you set the shutter speed manually and the camera automatically adjusts the aperture.	p.62
Av	Aperture Priority mode	This mode lets you set the aperture manually and the camera automatically selects the shutter speed.	p.63
M	Manual mode	In this mode you can set the shutter speed and aperture manually.	p.64

- 1** Turn the mode dial until the desired mode is located at the position of the indicator. Choose one of the following modes: PICT, **P**, Tv, Av, M.

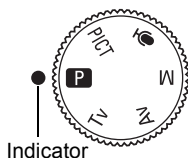

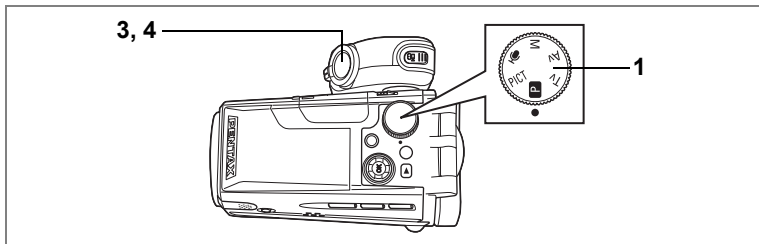

Setting the Functions (Program Mode)

In **P** (Program) mode, the camera automatically sets the shutter speed and aperture for taking still pictures. However, you can select other functions such as the flash mode or continuous shooting mode.

- 1 Set the mode dial to **P**.**
- 2 Set the functions you want to use.**

Refer to “Setting the Still Picture Shooting Functions” (p.67 to p.83) for details of how to set the functions.

- 3 Press the shutter release button halfway.**

The focus frame turns green if the subject is in focus.

- 4 Press the shutter release button down fully.**

The picture is taken.











Taking Still Pictures p.32

Selecting the Picture Mode According to the Shooting Scene (Picture Mode)

You can select the Picture mode according to the shooting scene.

There are ten available modes in Picture mode.

	Landscape	Lets you capture the bright colors of landscape views by emphasizing the contours and saturation of green trees, blue sky, etc.
	Flower	Lets you capture the vivid colors of flowers. The brightness of the image is maintained while the background is moderately blurred.
	Portrait	Lets you take portrait shots in natural tones. (Natural skin tone is captured by reducing the contrast.)
	Sport	Lets you take sharp pictures of a quickly moving subject, such as at a sporting event.
	Surf&Snow	Lets you take bright, vivid pictures of the sea, lakes or snow-covered landscapes in bright sunshine. (Views are vividly reproduced by slightly increasing the contrast.)
	Sunset	Lets you reproduce the beautiful colors of the sunrise or sunset. (Brilliant hues are captured by adjusting the exposure to create a slightly dark, twilight atmosphere and increasing the saturation a little.)
	Night Scene mode	Lets you capture evening or night views or take pictures of people against a nightscape. (The camera features a max. slow shutter speed of 4 seconds and has slow synchronization and noise reduction functions.)
SOFT	Soft	Lets you take pictures with the soft flare effect of a soft lens.
	Illustration	Lets you take illustration-type pictures.
	Panorama Assist	Lets you overlap the edges of your images so that they can be joined to form a panorama picture using the software supplied with the camera. (p.60)

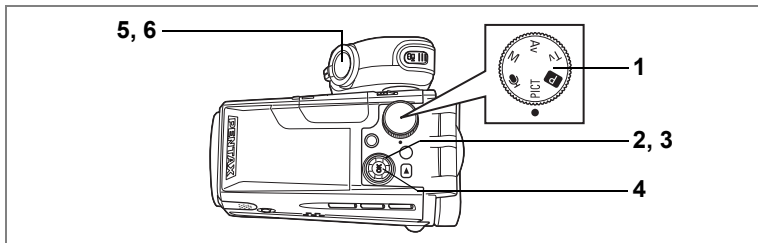

- 1 Set the mode dial to PICT.**
- 2 Press the four-way controller (▼).**
The Picture mode options screen appears.
- 3 Use the four-way controller (▲▼◀▶) to choose a Picture mode.**



- 4 Press the OK button.**
The Picture mode is selected.
- 5 Press the shutter release button halfway.**
The focus frame turns green if the subject is in focus.

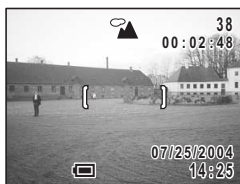

- 6 Press the shutter release button fully.**
The picture is taken.



The shutter speed is slower when taking pictures of dark scenes. To prevent camera shake, secure the camera on a tripod or other surface.



- In Picture mode, the saturation, contrast, sharpness and white balance are automatically set to the optimal settings for each mode. You cannot change the settings.
- Total recording time will be longer when the picture is taken at a slower shutter speed, because the noise reduction function activates to reduce noise.

Using the Shutter Release Button p.33

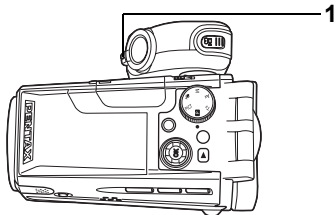

PICT Tv Av M

Using the Zoom

You can use the zoom to change the shooting area.

4

1 Press the Zoom// lever in Capture mode.

(Tele) : enlarges the subject.

(Wide) : enlarges the area captured by the camera.

The zoom bar indicates the current level of magnification.

When the digital zoom function is disabled, you can take pictures at up to 10-times magnification using the optical zoom. When the digital zoom function is set to $\times 10$, you can combine the digital zoom with the optical zoom to give a maximum zoom magnification equivalent to 100 times.

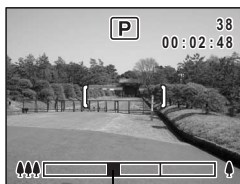

Zoom bar

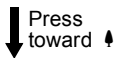



Optical zoom range Digital zoom range





- You are recommended to use a tripod to prevent camera shake when taking pictures at a high magnification rate.
- The zoom bar does not appear on the LCD monitor when zooming in or out during movie recording.

Two-Speed Zoom Operation

The zoom can be operated at high speed or at low speed.

Pressing the zoom lever gently toward  or  slowly changes the zoom magnification (low-speed zoom). Zoom adjustment stops when you remove your finger from the lever.

Pressing the zoom lever all the way toward  or  quickly changes the zoom magnification (high-speed zoom). Zoom adjustment stops when you remove your finger from the lever.



- To ensure smooth motion, avoid rapid zoom adjustment when recording movies.
- The high-speed zoom ensures that you capture the best snapshots.

Saving the Zoom Position  p.84

Setting the Digital Zoom

The default setting for the digital zoom is [×4]. To take pictures at the maximum magnification, set the digital zoom to [×10] and to take pictures using only the optical zoom, set the digital zoom to [Off].

1 Press the MENU button in Capture mode.

The [ Rec. Mode] menu appears.

2 Use the four-way controller (▲▼) to select [Digital Zoom].

3 Use the four-way controller (◀▶) to select [×4], [×10], [OFF].

4 Press the OK button.

The camera is ready to take pictures.

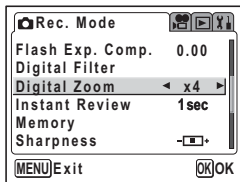

Saving the Digital Zoom Function Setting  p.84

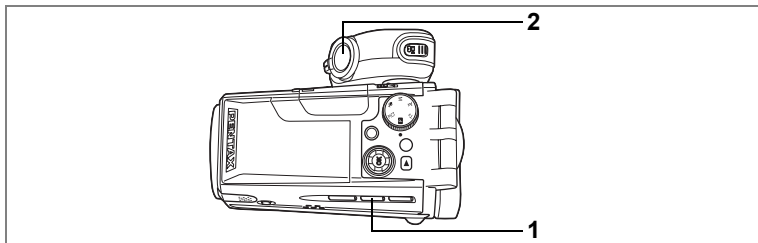

PICT Tv Av M

Using the Self-Timer

In self-timer mode, the picture is taken a fixed time after the shutter release button is pressed.

Use the 10-second self-timer when you want to be included in a group picture.

Use the 2-second self-timer to avoid camera shake when you press the shutter release button.

1 Press the button in Capture mode to display or on the LCD monitor.

2 Press the shutter release button.

The picture is taken approximately ten seconds after the shutter release button is pressed. The self-timer lamp lights for about seven seconds, then blinks for about three seconds.

The self-timer lamp blinks for about two seconds after the shutter release button is pressed and the picture is taken.



Caution

Focusing may be compromised if you move the camera while the self-timer lamp is blinking when taking still pictures.

memo

- If you press the button, recording movies will start after ten seconds (or two seconds).
- To cancel the self-timer, press any button, such as the MENU button, while the second count is displayed.

Taking Pictures of Yourself p.50

Troubleshooting: "Subject is not in focus" p.139

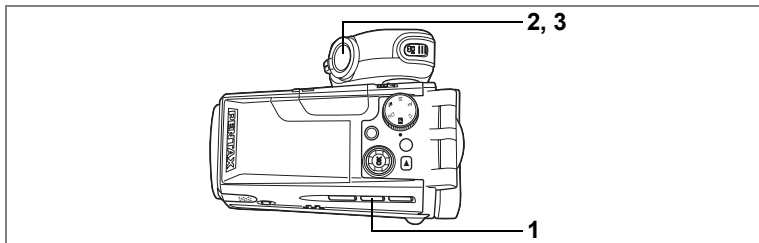

PICT **P** Tv Av M

Continuous Shooting (Continuous Shooting/ High-Speed Continuous Shooting Mode)

Pictures are taken continuously while the shutter release button is pressed.

- 1 Press the button in Capture mode to display or on the LCD monitor.**
- 2 Press the shutter release button halfway.**

The focus frame turns green if the subject is in focus.

- 3 Press the shutter release button fully.**

Pictures are taken continuously while the shutter release button is pressed. Shooting stops when you take your finger off the shutter release button.

- Each image is saved separately in the memory before the next image is taken. The higher the image quality, the longer the interval between shots.
- Up to two images are taken one after another while the shutter release button is pressed and are saved together in the memory. This action is repeated as long as the shutter release button is pressed, enabling high-speed continuous shooting in groups of up to two images.



- You can continue shooting until the SD Memory Card is full.
- The interval will vary according to the Recorded Pixels and Quality Level settings.



- The flash will not discharge in Continuous Shooting mode and High-Speed Continuous Shooting mode.
- Continuous shooting is not possible in Panorama Assist in PICT mode.
- The focus, exposure and white balance are locked with the first image.

4

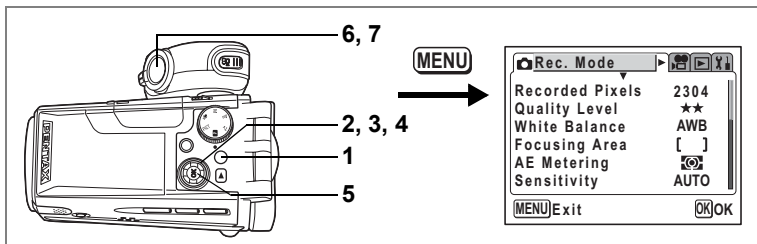

P Tv Av M

Taking Pictures with Color Filters (Digital Filter Mode)

4

You can take pictures using digital filters in a variety of colors, such as red, blue and green.

1 Press the MENU button in Capture mode.

The [Rec. Mode] menu appears.

2 Use the four-way controller (▲▼) to select [Digital Filter].

3 Press the four-way controller (▶).

The digital filter options screen appears.

4 Use the four-way controller (▲▼) to choose a digital filter.

You can choose from eight color filters: B&W, Sepia, Red, Pink, Purple, Blue, Green and Yellow.

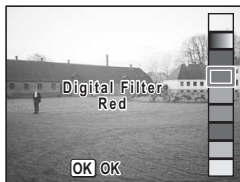

5 Press the OK button.

The color filter is selected and the camera returns to still picture capture status.

6 Press the shutter release button halfway.

The focus frame turns green if the subject is in focus.



7 Press the shutter release button fully.

The picture is taken.



- These digital filters are used for still pictures. Color filters for movies can be selected from [Color Mode] on the [Movie Mode] menu. (p.88)
- You can register the digital filter options screen on the OK button. This will enable you to display the digital filter options screen simply by pressing the OK button while taking pictures.
- You can also edit captured images using the digital filters.
- When Capture mode is changed, the digital filter setting is released.

Registering a Function on the OK Button p.132

Editing Pictures with Digital Filters p.113

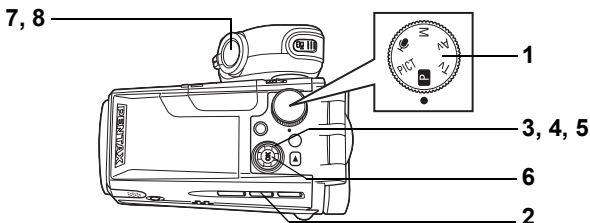

P Tv Av M

Varying the Settings Automatically (Auto Bracketing)

4 Auto bracketing can be used to automatically vary settings such as the exposure and white balance over a series of three shots when the shutter release button is pressed. This simple operation ensures that you are able to get the best shots.

Auto Bracket Settings

	Exposure	Pictures are taken in the following sequence: normal, underexposed (dark), overexposed (bright). Choose the bracketing steps from 0.25, 0.5, 0.75, 1.0, 1.25, 1.50, 1.75, 2.00.	p.83
	White Balance	Pictures are taken in the following sequence: normal, red tinge (low color temperature), blue tinge (high color temperature). Choose the bracketing steps from 1, 2, 3, 4, 5.	p.74
	Saturation	Pictures are taken in the following sequence: normal, low (-), high (+).	p.81
	Sharpness	Pictures are taken in the following sequence: normal, soft (-), hard (+).	p.80
	Contrast	Pictures are taken in the following sequence: normal, low (-), high (+).	p.82

- 1** Set the mode dial to other than PICT and .
- 2** Press the button to display .
- 3** Press the four-way controller ().
The auto bracketing options screen appears.
- 4** Use the four-way controller () to choose a function.



5 If you selected exposure or white balance, use the four-way controller (◀▶) to choose the bracketing steps.

6 Press the OK button.

The camera is ready to take pictures.
The function chosen for auto bracketing appears on the LCD monitor.



7 Press the shutter release button halfway.

The focus frame turns green if the subject is in focus.

8 Press the shutter release button fully.



Three pictures are taken in succession when  is selected and the shutter release button is pressed down fully in Step 8. Only one picture is taken when any other auto bracketing option is selected and the shutter release button is pressed down fully in Step 8, and the camera creates the series of three shots internally.



With the exception of the set functions (exposure, white balance, saturation, sharpness and contrast), the second and third pictures are taken under the same conditions as the first picture.

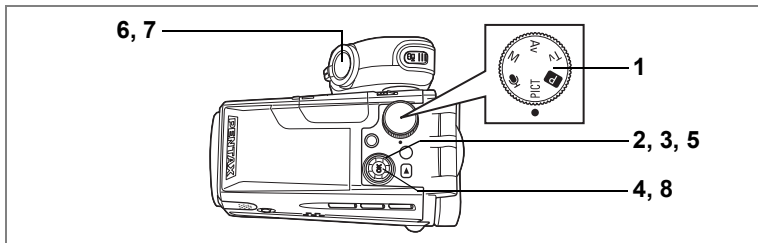

PICT

Taking Panorama Pictures (Panorama Assist)

You can take a number of images and join them together to form a panorama picture. The panorama software on the CD-ROM (S-SW23) supplied with the camera (ACDSee for PENTAX) and a computer are necessary for joining the images. The Panorama Assist enables you to overlap the edges of the images so that they are easier to join together into a panorama picture.

- 1 Set the mode dial to PICT.**
- 2 Press the four-way controller (▼).**
The Picture mode options screen appears.
- 3 Use the four-way controller (▲▼◀▶) to select  (Panorama Assist).**



- 4 Press the OK button.**
- 5 Use the four-way controller to choose the direction in which the images will be joined.**

- ◀ Joins the images at the left.
- ▶ Joins the images at the right.
- ▲ Joins the images at the top.
- ▼ Joins the images at the bottom.

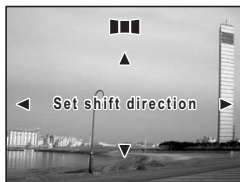

The example shows the images when ▶ is selected.

6 Take the first image.

Press the shutter release button to take the first image. The right edge of the image appears in semi-transparent form on the left of the LCD monitor.



7 Move the camera to the right and take the second image.

Move the camera until the semi-transparent image and the actual view overlap and press the shutter release button. Repeat Steps 6 and 7 to take the third and subsequent images.



8 Press the OK button.

The screen returns to Step 5.



To cancel Panorama Assist, change to another mode.



- The camera cannot join the images. Use the panorama software supplied with the camera (ACDSee for PENTAX, ACD photostitcher). Refer to the “PC Connection Manual – Enjoying Your Digital Camera Images On Your PC” for instructions on creating panorama pictures.
- Continuous shooting is not possible in Panorama Assist.

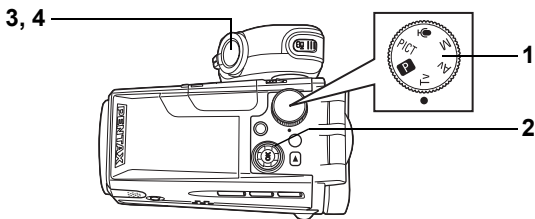

Tv

Shutter Priority Shooting

In this mode, you can set the shutter speed manually. The camera automatically sets the aperture to obtain the optimal exposure at the shutter speed you have chosen. Use this mode when you want to emphasize movement by setting a slow shutter speed to take a moving subject, etc.

- 1 Set the mode dial to Tv.**
- 2 Use the four-way controller (▲▼) to change the shutter speed.**
Pressing ▲ increases the speed and pressing ▼ reduces the speed.
- 3 Press the shutter release button halfway.**



The camera adjusts the aperture value accordingly. If the appropriate exposure cannot be obtained, the aperture value displayed on the LCD monitor turns orange. The focus frame turns green if the subject is in focus.

- 4 Press the shutter release button fully.**

The picture is taken.



Total recording time will be longer when the picture is taken at a slower shutter speed, because the noise reduction function activates to reduce noise.

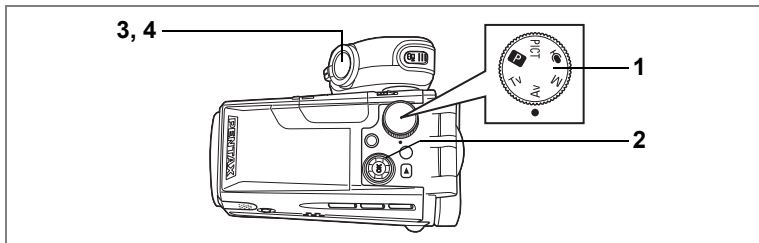

Av

Aperture Priority Shooting

In this mode, you can set the aperture manually. The camera automatically sets the shutter speed to obtain the optimal exposure at the aperture value you have chosen. Decreasing the aperture value will produce a picture with a blurred background. Increasing the value will produce a picture in which both the foreground and the background are in focus. Use this function when you want to intentionally change the focusing range (depth of field).

- 1 Set the mode dial to Av.**
- 2 Use the four-way controller (▲▼) to change the aperture value.**

Pressing ▲ increases the aperture and pressing ▼ reduces the aperture.

- 3 Press the shutter release button halfway.**

The camera adjusts the shutter speed accordingly.

If the appropriate exposure cannot be obtained, the shutter speed displayed on the LCD monitor turns orange.

The focus frame turns green if the subject is in focus.

- 4 Press the shutter release button fully.**

The picture is taken.



Total recording time will be longer when the picture is taken at a slower shutter speed, because the noise reduction function activates to reduce noise.

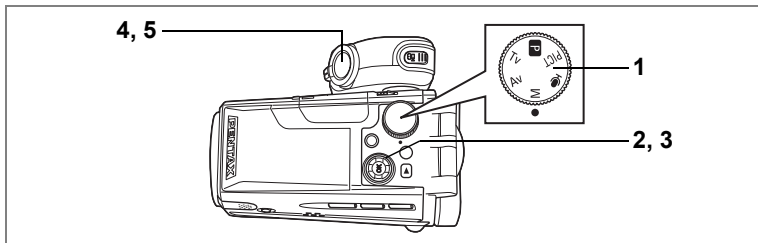

M

Manual Shooting

In this mode, you can set the shutter speed and aperture manually. This mode allows you to produce different creative effects in your pictures.

- 1 Set the mode dial to M.**
- 2 Use the four-way controller (▲▼) to change the aperture value.**
- 3 Use the four-way controller (◀▶) to change the shutter speed.**

Pressing ▲ increases the aperture and pressing ▼ reduces the aperture.

Pressing ▶ increases the speed and pressing ◀ reduces the speed. If the exposure you have set is unsuitable within the range of $\pm 2EV$, or and the range appears in the center at the bottom of the LCD monitor.

If the exposure you have set is unsuitable by more than $\pm 2EV$, or blinks.

- 4 Press the shutter release button halfway.**

The focus frame turns green if the subject is in focus.

- 5 Press the shutter release button fully.**

The picture is taken.



Total recording time will be longer when the picture is taken at a slower shutter speed, because the noise reduction function activates to reduce noise.

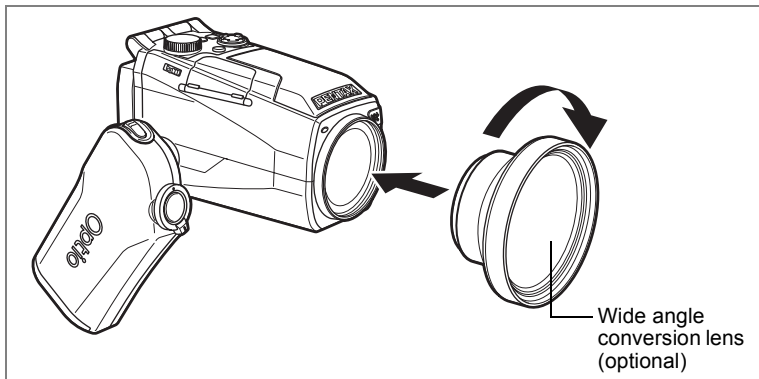

Using a Wide Angle Conversion Lens (Optional)

The L-WC17 wide angle conversion lens is available as an optional accessory. (p.135)

Simply screwing this useful accessory onto the front of the camera provides a wide angle equivalent to 27.75 mm (1.1 in) on a 35 mm (1.4 in) camera.



- The L-WC17 wide angle conversion lens is designed for use with the camera zoom at the maximum wide position (▲▲▲). Using the lens with the zoom in the ▲ position will result in poor quality images and is not recommended.
- Do not use a filter with the wide angle conversion lens as this may cause vignetting in the corners of the picture.
- Vignetting may occur at the bottom of the picture if the camera is too close to the subject when using the built-in flash.



The L-WC17 wide angle conversion lens can be used in Movie mode. In that case, use it with the camera zoom at the maximum wide position (▲▲▲) as in Still Picture mode.

Displaying Shooting Information in Capture Mode

The LCD monitor display changes each time you press the OK button. If [FILT.] has been registered on the OK button, change the setting to [DISPLAY] on the [FILT.] Set-up] menu. (p.126)

Norm. (Normal display)

Shooting information appears when the camera is turned on.

- | | |
|----------------------------|------------------|
| 1 Flash mode | 2 Drive mode |
| 3 Focus mode | 4 Capture mode |
| 5 Digital filter | 6 Digital zoom |
| 7 Remaining image count | 8 Remaining time |
| 9 Card status | 10 Date and time |
| 11 EV compensation | 12 Focus frame |
| 13 Battery level indicator | 14 Shutter speed |
| 15 Aperture | |

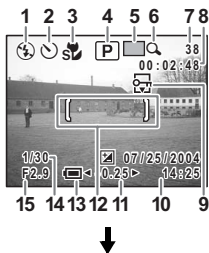

H+inf (Histogram and information)

The brightness distribution of the image is displayed. The horizontal axis of the histogram shows the brightness (darkest at the left end and brightest at the right end) and the vertical axis shows the number of pixels.

- | | |
|-----------------|-------------------|
| 1 White balance | 2 Recorded pixels |
| 3 Quality level | 4 Sensitivity |
| 5 Histogram | 6 AE metering |

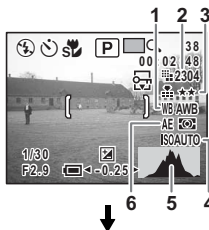

Grid (Grid display or Normal display in Playback mode)

A grid appears to help you compose your pictures.

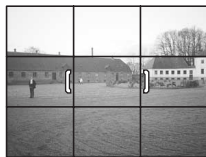

Frame (Frame only and no information)

No shooting information is displayed.

- The focus frame appears in Autofocus mode.
- If any of the modes are changed, such as the flash mode, the new setting appears on the LCD monitor for a few seconds.



Norm. (Normal display)

Saving the Display Mode p.84

Setting the Still Picture Shooting Functions

Shooting and Playback

Capture mode is for taking and recording images. The shutter release button is for taking still pictures in Capture mode and the  button is for taking movies.

Playback mode is for viewing captured pictures. The displayed picture can be edited in Playback mode.

Follow the procedure below to switch between Still Picture mode and Movie mode and between Capture mode and Playback mode.

To Change from Capture Mode to Playback Mode

- 1 Press the  button in Capture mode.**

The camera switches to Playback mode.

To Change from Playback Mode to Capture Mode

- 1 Press the  button or the  button.**

or

- 1 Press the shutter release button halfway.**

The camera switches to Capture mode.

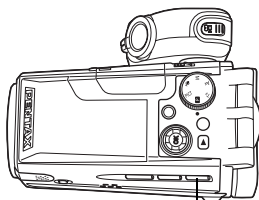

1

PICT Tv Av M

Selecting the Focus Mode

Focus Modes

(No icon)	Autofocus mode	The camera focuses on the object in the focusing area when the shutter release button is pressed halfway. Use this mode when the distance to the subject is more than 40 cm (16 in) when zoomed out and more than 120 cm (47 in) when zoomed in.
	Macro mode	This mode is used when the distance to the subject is approx. 10 cm – 50 cm (4 in – 20 in) when zoomed out and approx. 60 cm – 150 cm (24 in – 59 in) when zoomed in. The camera focuses on the object in the autofocus area when the shutter release button is pressed halfway.
	Super Macro mode	This mode is used when the distance to the subject is approx. 0 cm – 15 cm (0 in – 6 in). The camera focuses on the object in the focusing area when the shutter release button is pressed halfway.
	Infinity-Landscape mode	This mode is used for taking distant objects. The flash is automatically set to (flash off).
MF	Manual Focus mode	This mode lets you adjust the focus manually with the four-way controller.

1 Press the MF button in Capture mode.

The focus mode changes each time the button is pressed and the icon appears on the LCD monitor.

The camera is ready to take pictures in the selected focus mode.



Make sure that the surface of the lens is clean as any dirt on the lens in mode may cause the camera to focus on the dirt rather than on the subject.



- The default setting is Autofocus mode.
- Only the digital zoom can be used in mode.



Manual Focus

The procedure for setting the focus manually is described below.

1 Press the MF button in Capture mode to display MF.

The central portion of the screen is magnified twice as large when focusing.

2 Press the four-way controller (.

The indicator appears on the LCD monitor. Using the indicator as a guide, adjust the focus with the four-way controller ( .







For distant focus





For closer focus



Indicator

After the focus is set, press any button except the four-way controller ( ) or take your finger off the four-way controller ( ). The screen returns to the normal display about two seconds later.



- When focusing, hold down the four-way controller ( ) to focus quickly.
- You cannot adjust the shutter speed or aperture when **M**, **Tv** or **Av** is selected in **MF** mode.

Saving the Focus Mode  p.84

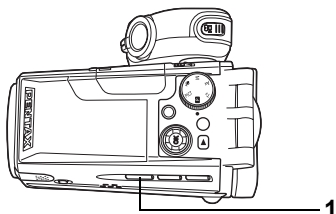

PICT Tv Av M

Selecting the Flash Mode

Flash Modes

(No icon)	Auto	The flash discharges automatically depending on the light conditions.
	Flash Off	The flash will not discharge, regardless of the light conditions. Use this mode to take pictures at dusk or in museums etc. where flash photography is prohibited.
	Flash On	The flash discharges regardless of the brightness.
	Auto + Red-eye reduction	This mode reduces the phenomenon of red eyes caused by the light from the flash being reflected in the subject's eyes. The flash discharges automatically.
	Flash On + Red-eye reduction	This mode reduces the phenomenon of red eyes caused by the light from the flash being reflected in the subject's eyes. The flash will discharge regardless of the light conditions.



- To use the flash, press the button to make the flash pop up. When the flash is closed, it will not discharge (Flash Off).
- The flash will not discharge (Flash Off) when the drive mode is set to or or the focus mode is set to or .
- The flash discharges twice, first a pre-flash and then a second time to take the picture. In the red-eye reduction modes, the interval between the pre-flash and the main flash is longer.
- You cannot select Auto or Auto + Red-eye Reduction in **M**, **Tv** or **Av** mode.
- Use the flash to prevent camera shake if blinks when the shutter release button is pressed halfway.

1 Press the button in Capture mode.

The flash mode changes each time the button is pressed and the icon appears on the LCD monitor.

The camera is ready to take pictures in the selected flash mode.

Saving the Flash Mode p.84

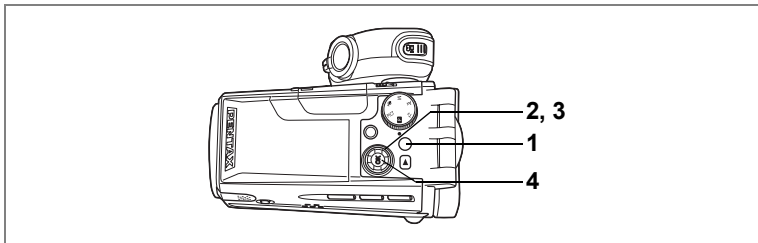

PICT Tv Av M

Adjusting the Flash Intensity

You can adjust the amount of light emitted by the flash.

1 Press the MENU button in Capture mode.

The [Rec. Mode] menu appears.

2 Use the four-way controller (▲▼) to select [Flash Exp. Comp.].

3 Use the four-way controller (◀▶) to change the light emission.

To increase the light emission, set a positive (+) value. To decrease the light emission, set a negative (-) value.

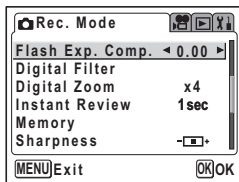

When a positive value has been set, the flash icon appears as +, and when a negative value has been set, the flash icon appears as -.

4 Press the OK button.

The camera is ready to take pictures.

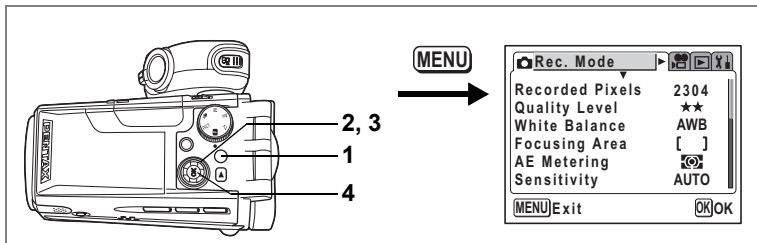

PICT Tv Av M

Selecting the Recorded Pixels

You can choose the number of recorded pixels of still pictures from [2304×1728], [1600×1200], [1024×768] and [640×480].

The more pixels, the bigger the picture and the larger the filesize. The quality level setting also affects the filesize of your pictures (see p.73).

Recorded Pixels

2304 (2304×1728)	Suitable for printing on A4 paper
1600 (1600×1200)	Suitable for printing on paper slightly larger than a postcard
1024 (1024×768)	Suitable for printing on postcards
640 (640×480)	Suitable for attaching to e-mails or creating websites

1 Press the MENU button in Capture mode.

The [Rec. Mode] menu appears.

2 Use the four-way controller (▲▼) to select [Recorded Pixels].

3 Use the four-way controller (◀▶) to change the recorded pixels.

4 Press the OK button.

The camera is ready to take pictures.

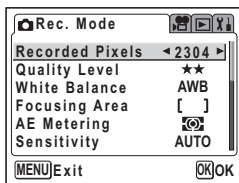

- The larger your recorded pixels, the finer the details will appear when you print your picture.
- The Recorded Pixels setting is saved when the camera is turned off.

Recorded Pixels and Quality of Still Pictures see p.20

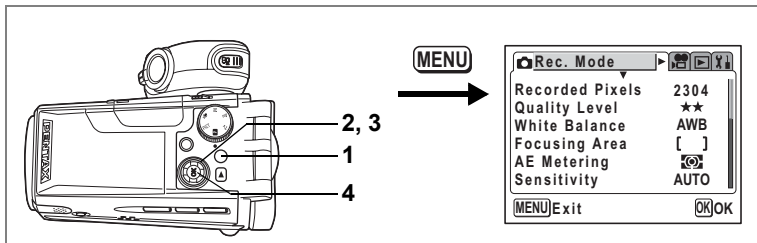

PICT **P** Tv Av M

Selecting the Quality Level

Image quality refers to the compression rate of still pictures. The more stars, the higher the quality and the larger the filesize. The recorded pixels setting also affects the filesize of your pictures (p.72).

Quality Levels

★★★ (Best)	Lowest compression rate. Suitable for photo prints.
★★ (Better)	Standard compression rate. Suitable for viewing the image on a computer screen.
★ (Good)	Highest compression rate. Suitable for attaching to e-mails or creating websites.

1 Press the MENU button in Capture mode.

The [Rec. Mode] menu appears.

2 Use the four-way controller (▲▼) to select [Quality Level].

3 Use the four-way controller (◀▶) to change the quality level.

4 Press the OK button.

The camera is ready to take pictures.

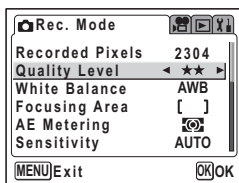

The Quality Level setting is saved when the camera is turned off.

Recorded Pixels and Quality of Still Pictures p.20

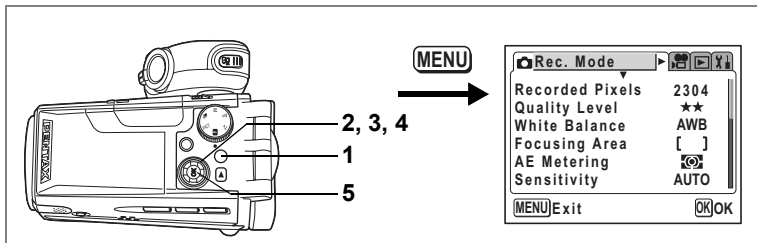

P Tv Av M

Adjusting the White Balance

You can take pictures in natural colors by adjusting the white balance according to the light conditions at the time of shooting.

White Balance Settings

AWB (Auto)	The camera adjusts the white balance automatically.
(Daylight)	Use this mode when taking pictures outside in sunlight.
(Shade)	Use this mode when taking pictures outside in the shade.
(Tungsten Light)	Use this mode when taking pictures under electric or other tungsten light.
(Fluorescent Light)	Use this mode when taking pictures under fluorescent light.
(Manual)	Use this mode when adjusting the white balance manually.

- 1 Press the MENU button in Capture mode.**
The [📷 Rec. Mode] menu appears.
- 2 Use the four-way controller (▲▼) to select [White Balance].**
- 3 Press the four-way controller (▶).**
The White Balance screen appears.
- 4 Use the four-way controller (▲▼) to change the setting.**
- 5 Press the OK button twice.**
The camera is ready to take pictures.

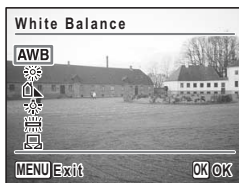



Saving the White Balance p.84

Auto Bracketing p.58

Manual Setting

Have a blank sheet of white paper ready.

- 1 Select  (manual) on the White Balance screen.**
- 2 Point the camera at the blank sheet of paper so that it fills the screen of the LCD monitor.**
- 3 Press the  button.**

The shutter is released and the white balance is automatically adjusted.

[Complete] appears on the LCD monitor when adjustment is finished and the display returns to the [ Rec. Mode] menu.

- 4 Press the OK button.**

The camera is ready to take pictures.

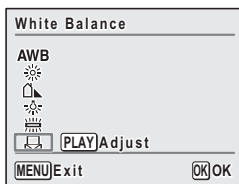

Any changes made to the White Balance setting are invalid in PICT mode.

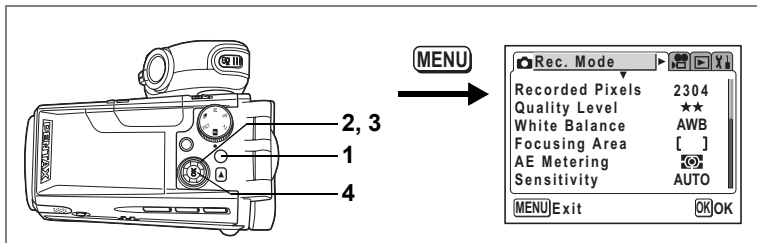

PICT **P** Tv Av M

Changing the Focusing Area

You can change the autofocus area (Focusing Area).

4

Focusing Area

[] (Multiple)	Normal range
[] (Spot)	The autofocus range becomes smaller.

1 Press the MENU button in Capture mode.

The [Rec. Mode] menu appears.

2 Use the four-way controller (▲▼) to select [Focusing Area].

3 Use the four-way controller (◀▶) to change the setting.

4 Press the OK button.

The camera is ready to take pictures.

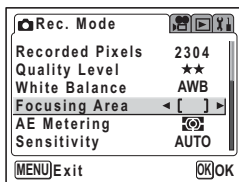

Saving the Focusing Area Setting p.84

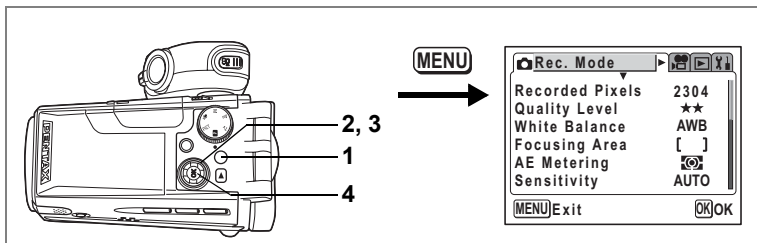

PICT Tv Av M

Setting the Light Metering Range to Determine the Exposure (AE Metering)

You can choose which part of the screen to use to measure the brightness and determine the exposure.

AE Metering Modes

	(Multi-segment)	The exposure is determined by the entire screen.
	(Center-weighted)	The exposure is determined mainly by the center of the screen.
	(Spot)	The exposure is determined by the small area in the center of the screen only.

1 Press the MENU button in Capture mode.

The [Rec. Mode] menu appears.

2 Use the four-way controller () to select [AE Metering].

3 Use the four-way controller () to change the AE Metering mode.

4 Press the OK button.

The camera is ready to take pictures.

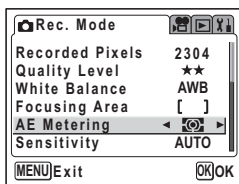

Saving the AE Metering Mode p.84

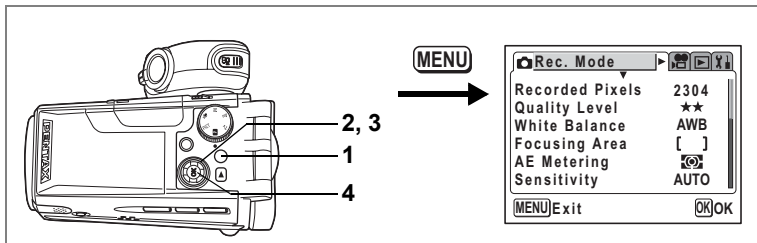

PICT Tv Av M

Setting the Sensitivity

You can select the sensitivity to suit the brightness of the surroundings.

4

Sensitivity Settings

AUTO	The camera sets the sensitivity automatically.
100	• The lower the sensitivity, the sharper the image and the less noise. The shutter speed will be slower in low light conditions.
200	• The higher the sensitivity, the faster the shutter speed in low light conditions to reduce camera shake, but the image may be affected by noise.
400	

1 Press the MENU button in Capture mode.

The [Rec. Mode] menu appears.

2 Use the four-way controller () to select [Sensitivity].

3 Use the four-way controller () to change the sensitivity.

4 Press the OK button.

The camera is ready to take pictures.

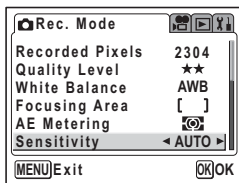

Saving the Sensitivity p.84

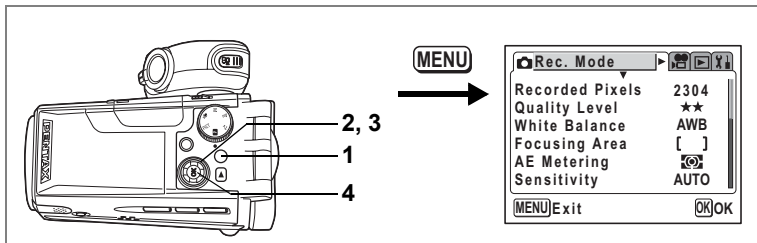

PICT **P** Tv Av M

Setting the Instant Review Time (Instant Review)

You can choose the Instant Review time from 1 sec, 2 sec, 3 sec, 5 sec and Off (no display).

1 Press the MENU button in Capture mode.

The [📷 Rec. Mode] menu appears.

2 Use the four-way controller (▲▼) to select [Instant Review].

3 Use the four-way controller (◀▶) to change the display time.

4 Press the OK button.

The camera is ready to take pictures.

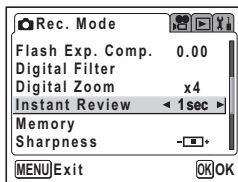

The Instant Review setting is saved when the camera is turned off.

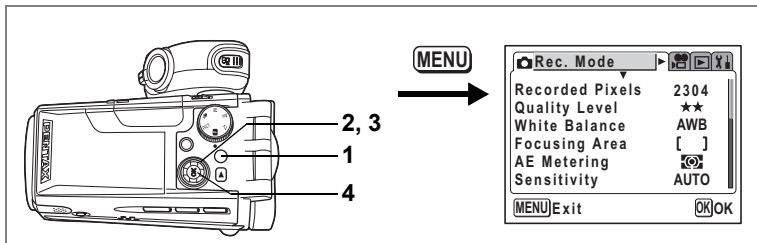

P Tv Av M

Setting the Image Sharpness (Sharpness)

You can choose whether you want the image to have sharp or soft outlines.

1 Press the MENU button in Capture mode.

The [Rec. Mode] menu appears.

2 Use the four-way controller (▲▼) to select [Sharpness].

3 Use the four-way controller (◀▶) to change the setting from [Normal] to [Hard (+)] or [Soft (-)].

To soften the contours, choose (-) and to sharpen the contours, choose (+).

4 Press the OK button.

The camera is ready to take pictures.

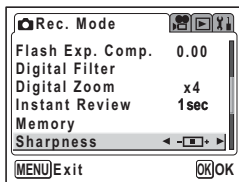

- Any changes made to the Sharpness setting are invalid in PICT mode.
- The Sharpness setting is saved when the camera is turned off.

Auto Bracketing p.58

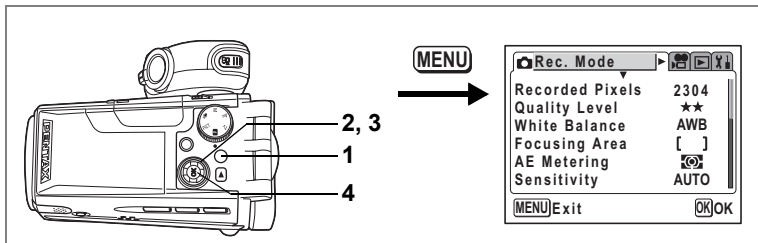

Tv Av M

Setting the Color Saturation (Saturation)

You can set the color saturation.

1 Press the MENU button in Capture mode.

The [Rec. Mode] menu appears.

2 Use the four-way controller () to select [Saturation].

3 Use the four-way controller () to change the setting from

[Normal] to [High (+)] or [Low (-)].

To reduce the saturation, choose (-) and to increase the saturation, choose (+).

4 Press the OK button.

The camera is ready to take pictures.

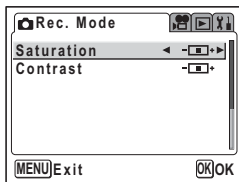

- Any changes made to the Saturation setting are invalid in PICT mode.
- The Saturation setting is saved when the camera is turned off.

Auto Bracketing p.58

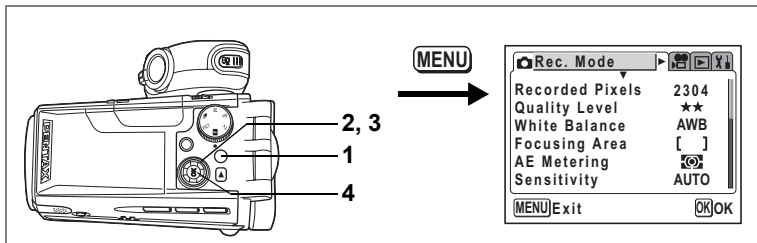

P Tv Av M

Setting the Image Contrast (Contrast)

You can set the image contrast.

1 Press the MENU button in Capture mode.

The [Rec. Mode] menu appears.

2 Use the four-way controller (▲▼) to select [Contrast].

3 Use the four-way controller (◀▶) to change the setting from [Normal] to [High (+)] or [Low (-)].

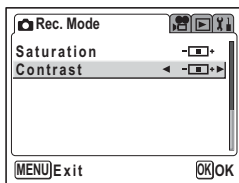

To reduce the contrast, choose (-) and to increase the contrast, choose (+).

4 Press the OK button.

The camera is ready to take pictures.



- Any changes made to the Contrast setting are invalid in PICT mode.
- The Contrast setting is saved when the camera is turned off.

Auto Bracketing p.58

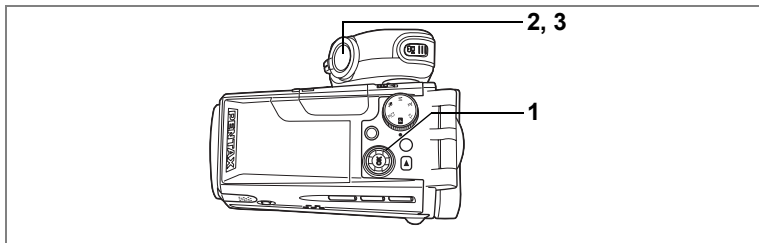

PICT Tv Av

Setting the Exposure (EV Compensation)

You can adjust the overall brightness of the picture. Use this function to take pictures that are intentionally overexposed or underexposed.

1 Press the four-way controller (◀▶) in Capture mode.

You can change the EV setting. To brighten, set a positive (+) value. To darken, set a negative (-) value. You can choose the EV setting in the range of -2.0 EV to +2.0 EV in 0.25 EV steps.



2 Press the shutter release button halfway.

The focus frame turns green if the subject is in focus.

3 Press the shutter release button fully.

The picture is taken.

Saving the EV Compensation Value p.84

Auto Bracketing p.58

Saving the Settings (Memory)

You can choose whether you want the set values to be saved when the camera is turned off or returned to the defaults. The items that can be saved or reset are listed below. If you select (On), the settings will be saved in the status they were in immediately before the camera was turned off. If you select (Off), the settings will be reset to the defaults when the camera is turned off. Items not listed here will also be saved in the selected settings when the camera is turned off.

Item	Description	Default Setting
Flash Mode	The flash mode set with the button (p.70)	<input checked="" type="checkbox"/>
Drive Mode	The drive mode set with the button (p.54, 55, 58)	<input type="checkbox"/>
Focus Mode	The focus mode set with the MF button (p.68)	<input type="checkbox"/>
Zoom Position	The optical zoom position set with the Zoom lever (p.52)	<input type="checkbox"/>
MF	The manual focus position set with the MF button (p.69)	<input type="checkbox"/>
White Balance	The [White Balance] setting on the [Rec. Mode] menu (p.74)	<input type="checkbox"/>
Focusing Area	The [Focusing Area] setting on the [Rec. Mode] menu (p.76)	<input type="checkbox"/>
AE Metering	The [AE Metering] setting on the [Rec. Mode] menu (p.77)	<input type="checkbox"/>
Sensitivity	The [Sensitivity] setting on the [Rec. Mode] menu (p.78)	<input type="checkbox"/>
EV Compensation	The EV compensation value set with the four-way controller () (p.83)	<input type="checkbox"/>
Flash Exp. Comp.	The [Flash Exp. Comp.] setting on the [Rec. Mode] menu (p.71)	<input type="checkbox"/>
Digital Zoom	The [Digital Zoom] setting on the [Rec. Mode] menu (p.53)	<input checked="" type="checkbox"/>
DISPLAY	The LCD monitor display mode (p.66, 101)	<input type="checkbox"/>
File #	The file number is saved. If a new SD Memory Card is inserted when On has been selected, file numbers are assigned sequentially.	<input checked="" type="checkbox"/>



The zoom position setting in the digital zoom range will not be saved even if [Zoom Position] is set to On in [Memory].

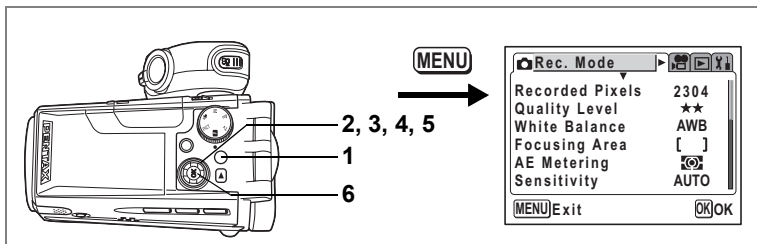

1 Press the MENU button in Capture mode.

The [📷 Rec. Mode] menu appears.

2 Use the four-way controller (▲▼) to select [Memory].

3 Press the four-way controller (▶).

The Memory screen appears.

4 Use the four-way controller (▲▼) to choose an item.

5 Use the four-way controller (◀▶) to select (On) or (Off).

6 Press the OK button twice.

The camera is ready to take pictures.

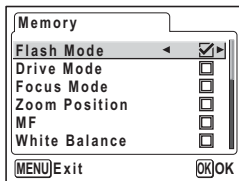
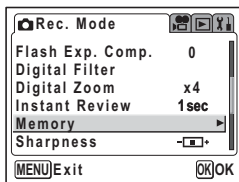

Recording Movies

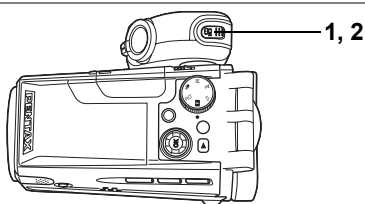

Recording Movies

This mode lets you take movies. Sound is recorded at the same time.

1 Press the button in Capture mode.

Recording starts.

The following information appears on the LCD monitor.

1 Movie mode icon

2 Recording indicator (blinks during recording)

3 Remaining recording time

You can change the captured area by pressing the Zoom/ lever to the right or left.

 : enlarges the subject.

 : enlarges the area captured by the camera.



- The zoom bar does not appear on the LCD monitor by pressing the zoom lever while recording movies.
- When the shutter release button is pressed during movie recording, the focus is locked for as long as the button is held down.



2 Press the button.

Recording stops.



- You cannot change from Voice Recording mode to Movie mode.
- The flash will not discharge in Movie mode.
- The maximum movie recording time is 120 minutes.
- The self-timer lamp lights while recording movies.
- When recording movies, sound is recorded at the same time. Be careful not to cover the microphone or the holes at the side of the microphone with your finger.

Keeping the Button Pressed

Recording starts when you keep the  button pressed for more than one second. Recording will continue for as long as you keep the button pressed. Recording stops when you take your finger off the  button.

Using the Zoom When Taking Movies

If you use the zoom when taking movies, hold the camera steady and zoom in and out slowly using the low-speed zoom. Operating the zoom too quickly or failing to hold the camera steady will affect the quality of your movies.



You are recommended to use a tripod to prevent camera shake when taking pictures at a high magnification rate.

Focusing Range When Taking Movies

Focus mode	Wide	Tele
Autofocus (Normal) Macro Super Macro	0.1m – ∞	1.2m – ∞
Landscape	∞	∞
Manual Focus	0cm – ∞	60cm – ∞

Using the Zoom  p.52

Holding the Camera  p.25

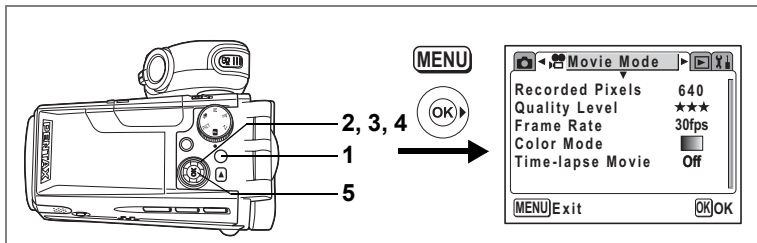

Adding a Color Effect to Movies (Color Mode)

You can add a color effect to movies by using color filters. As well as recording in normal colors, you can choose a B&W filter or a Sepia filter.

1 Press the MENU button in Capture mode.

The [📷 Rec. Mode] menu appears.

2 Use the four-way controller (◀▶) to select the [🎥 Movie Mode] menu.

3 Use the four-way controller (▲▼) to select [Color Mode].

4 Use the four-way controller (◀▶) to choose a color.

5 Press the OK button.

The selected color mode is enabled.

The camera is ready to record.

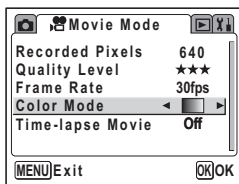

Digital filters are available for use with still pictures. (📄 p.56)

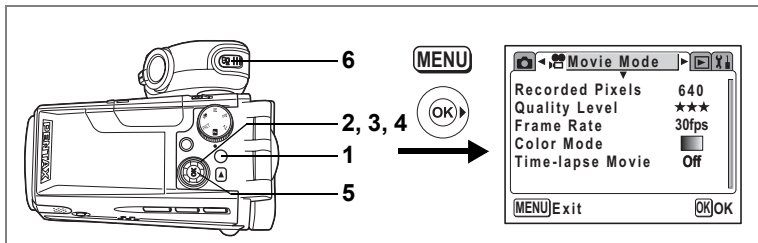

Taking Time-lapse Movies

This mode lets you take movies at a delayed frame rate so that when you play the movie back at the normal frame rate, the action appears speeded up. For example, if you choose the $\times 2$ setting, half the normal number of frames will be taken, so that when you play the movie back at the normal frame rate, the subject will move at twice the normal speed.

1 Press the MENU button in Capture mode.

The [Rec. Mode] menu appears.

2 Use the four-way controller (◀▶) to select the [Movie Mode] menu.

3 Use the four-way controller (▲▼) to select [Time-lapse Movie].

4 Use the four-way controller (◀▶) to change the time-lapse setting.

5 Press the OK button.

The camera switches to Capture mode.

6 Press the button.

Recording starts.



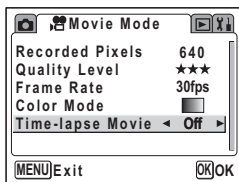



The selected time-lapse setting appears on the LCD monitor.



- When the frame rate is set to [30fps], you can choose from [$\times 2$], [$\times 5$], [$\times 10$] and [$\times 20$].
- When the frame rate is set to [15fps], you can choose from [$\times 2$], [$\times 5$] and [$\times 10$].
- It may take some time to exit Time-lapse Movie mode depending on when you stop recording.

Setting the Movie Shooting Functions

There are a number of functions that you can set for recording movies. However, the following functions use the settings for taking still pictures. Refer to the relevant reference pages listed below.

Adjusting the White Balance	 p.74
Setting the Light Metering Mode to Determine the Exposure	 p.77
Setting the Sensitivity	 p.78
Setting the Image Sharpness	 p.80
Setting the Color Saturation	 p.81
Setting the Image Contrast	 p.82
Setting the Exposure	 p.83

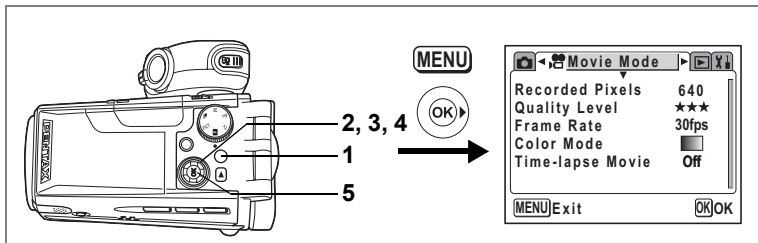

Selecting the Recorded Pixels for Movies

You can choose the number of recorded pixels for movies from [640×480], [320×240] and [160×120].

The more pixels, the bigger the picture and the larger the filesize. The quality level setting also affects the filesize of your pictures (see p.92).

Recorded Pixels for Movies

640 (640×480)	VGA size. Produces high quality images for viewing on a TV. Large filesize.
320 (320×240)	Suitable for viewing on a PC.
160 (160×120)	Small filesize. Suitable for attaching to e-mails or displaying on websites.

1 Press the MENU button in Capture mode.

The [Rec. Mode] menu appears.

2 Use the four-way controller (◀▶) to select the [Movie Mode] menu.

3 Use the four-way controller (▲▼) to select [Recorded Pixels].

4 Use the four-way controller (◀▶) to change the number of recorded pixels.

5 Press the OK button.

The camera is ready to record.

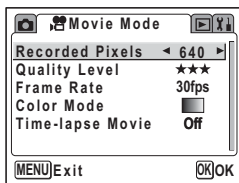

The Recorded Pixels setting is saved when the camera is turned off.

Recorded Pixels and Quality of Movies see p.21

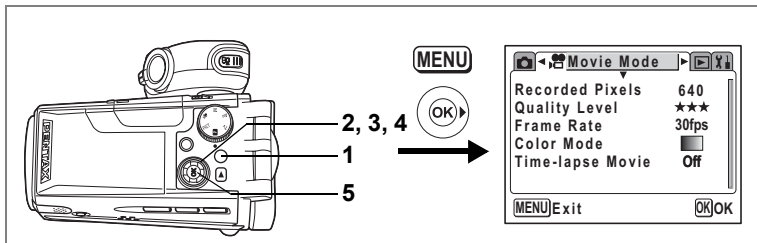

Selecting the Quality Level of Movies

The more stars, the higher the quality and the larger the filesize. The recorded pixels setting also affects the filesize of your pictures (see p.91).

Quality Levels of Movies

★★★ (Best)	Produces high quality movies for viewing on a TV.
★★ (Better)	Suitable for sending by high-speed Internet circuit.
★ (Good)	Suitable for attaching to e-mails.

1 Press the MENU button in Capture mode.

The [📷 Rec. Mode] menu appears.

2 Use the four-way controller (◀▶) to select the [🎥 Movie Mode] menu.

3 Use the four-way controller (▲▼) to select [Quality Level].

4 Use the four-way controller (◀▶) to change the quality level.

5 Press the OK button.

The camera is ready to record.

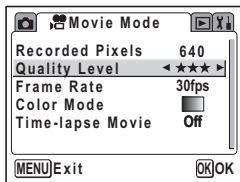

The Quality Level setting is saved when the camera is turned off.

Recorded Pixels and Quality of Movies see p.21

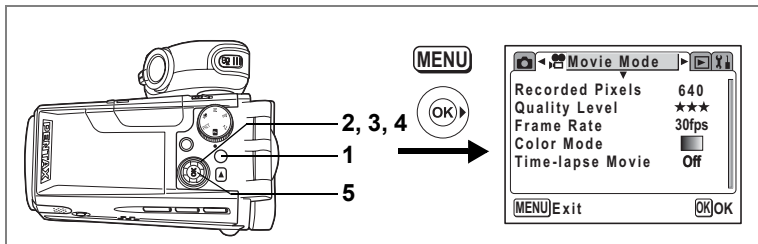

Selecting the Frame Rate

The frame rate refers to the number of frames taken per second. The higher the frame rate, the better the quality and the larger the filesize. There are two frame rates to choose from: 30fps and 15fps.

- 1 Press the MENU button in Capture mode.**
The [📷 Rec. Mode] menu appears.
- 2 Use the four-way controller (◀▶) to select the [🎥 Movie Mode] menu.**
- 3 Use the four-way controller (▲▼) to select [Frame Rate].**
- 4 Use the four-way controller (◀▶) to select [30fps] or [15fps].**
- 5 Press the OK button.**
The camera is ready to record.



The Frame Rate setting is saved when the camera is turned off.

Recorded Pixels and Quality of Movies ☞ p.21

Recording Sound (Voice Recording Mode)

You can record sound with the camera.

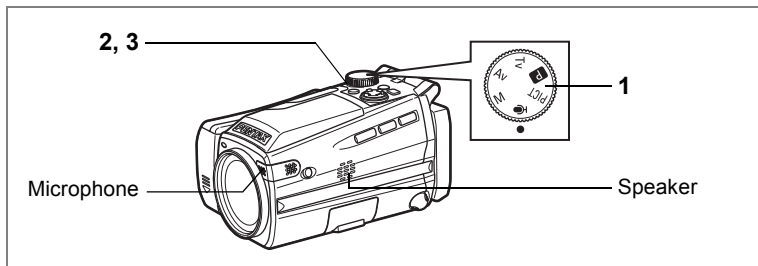

1 Set the mode dial to and press the power switch.

The remaining recording time and the recording time of the current file appear on the LCD monitor.

- 1 Current recording time
- 2 Remaining recording time

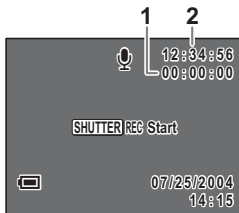

2 Press the shutter release button.

Recording starts. The self-timer lamp lights during recording.

When the shutter release button is pressed for more than one second, recording continues for as long as the button is held down and stops when the button is released. When the  button is pressed during recording, an index can be added to the current sound file.



3 Press the shutter release button.

Recording stops.





- Sound is saved in WAVE monaural files.
- The microphone is located at the side of the lens. Aim the camera to obtain the best sound.
- Pressing the OK button turns the LCD monitor off and pressing the OK button again turns the monitor back on.

Playing Back Sound

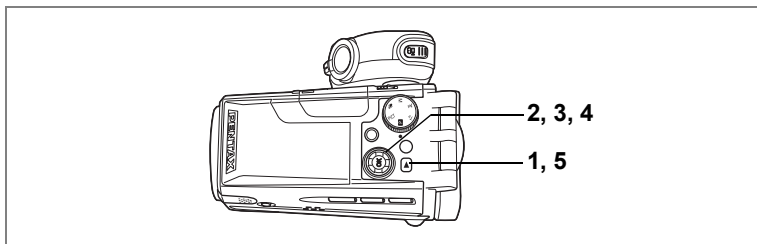
You can play back the sound files you made in Voice Recording mode.



- 1 Press the  button.**
- 2 Use the four-way controller ( ) to choose a sound file to play back.**

- 3 Press the four-way controller () .**

Playback starts.

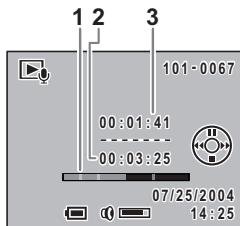

- 1** Index position
- 2** Total file recording time
- 3** Playback time





The following operations can be performed during playback.





Four-way controller () Pauses playback
Press again to resume playback

If there are no recorded indexes:

- Four-way controller () Rewinds approx. 5 seconds
- Four-way controller () Advances approx. 5 seconds

If there are recorded indexes:

- Four-way controller () Plays back from the previous index
- Four-way controller () Plays back from the next index

- Zoom//Q lever () Increases the volume
- Zoom//Q lever () Reduces the volume

- 4 Press the four-way controller () .**

Playback stops.

- 5 Press the  button.**

The camera switches to Voice Recording mode.

Adding a Voice Memo to Images

You can add a voice memo to your still pictures.

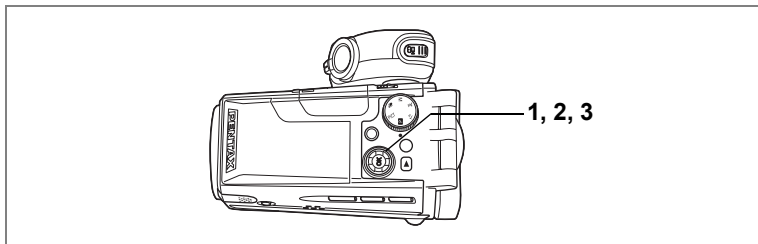

Recording a Voice Memo

- 1 Enter the Playback mode and use the four-way controller (◀▶) to choose the still picture to which you want to add a voice memo.**

🎤 appears on the four-way controller operation guide on the LCD monitor if there is no voice memo attached to the displayed image.

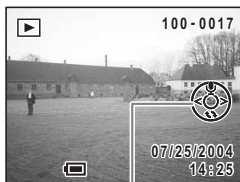

Four-way controller operation guide

- 2 Press the four-way controller (▲).**
Recording starts. You can record for up to 30 seconds.
- 3 Press the four-way controller (▲).**
Recording stops.

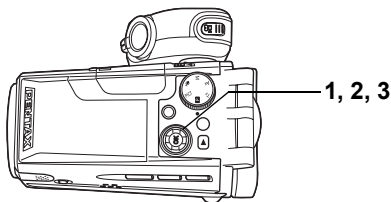

Playing Back a Voice Memo

- 1 Enter the Playback mode and use the four-way controller (◀▶) to choose the still picture with the voice memo that you want to play back.**

If [] appears on the displayed image, a voice memo has been recorded.



- 2 Press the four-way controller (▲).**

Playback starts.

The following operations can be performed during playback.

- Zoom/ [] / Q lever (▲) Increases the volume
- Zoom/ [] / Q lever (▼) Reduces the volume

- 3 Press the four-way controller (▲).**

Playback stops.

Deleting a Voice Memo p.106



A voice memo cannot be added to a still picture which already has a voice memo. Delete the old voice memo and record a new one. (p.106)



A voice memo cannot be added to protected () images. (p.108)

Playing Back Still Pictures

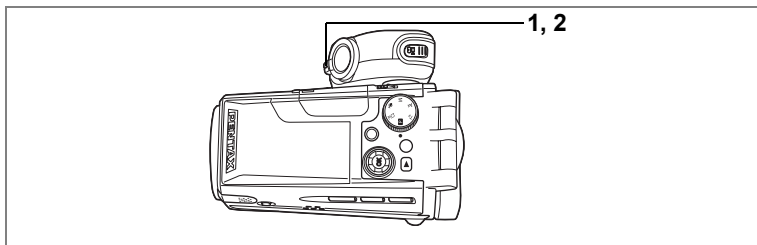

Playing Back Still Pictures

Press the button.

Refer to “Playing Back Images” (p.34) for instructions.

Nine Image Display

You can display nine images at the same time.

1 Press the Zoom//Q lever toward in Playback mode.

Nine images appear with the selected image at the bottom center.

Use the four-way controller (, , ,) to choose one of the images. If you choose image ① and press the four-way controller () when ten or more images have been recorded, the previous nine images appear. Similarly, if you choose image ② and press the four-way controller (), the next nine images appear.

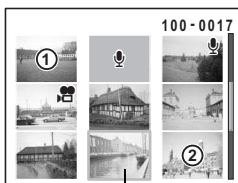

Selected image

The icons that appear on the images indicate the following:

- No icon : Still picture without voice memo
- (with image) : Still picture with voice memo
- : Movie (first frame appears)
- (without image) : Sound file only

2 Press the Zoom//Q lever toward .

The screen returns to full screen display of the selected image.

Pressing the OK button also returns the screen to full screen display of the selected image.

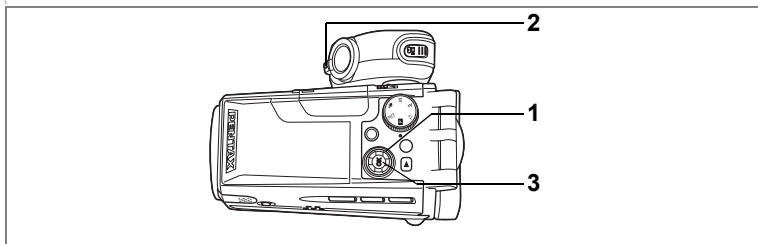

Zoom Display

You can display images magnified up to 12 times. A guide to operation appears on the LCD monitor during magnification.

1 Enter the Playback mode and use the four-way controller (◀▶) to choose an image to magnify.

2 Press the Zoom/⏏/Q lever toward Q.

The image is magnified (×1.2 to ×12). Holding down the button changes the magnification continuously.

The following operations can be performed while the magnified image is displayed.

Four-way controller (▲▼◀▶) Changes the magnified portion of the image

Zoom/⏏/Q lever (♣) Makes the image bigger

Zoom/⏏/Q lever (♠♠♠) Makes the image smaller



3 Press the OK button.

Zoom playback ends.



Movies cannot be magnified.

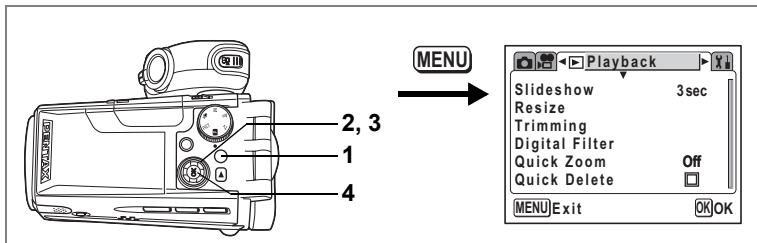

Setting the Quick Zoom Function

You can display the image at set magnification simply by pressing the Zoom//Q lever toward Q once during zoom playback.

1 Press the MENU button in Playback mode.

The [Playback] menu appears.

2 Use the four-way controller () to select [Quick Zoom].

3 Use the four-way controller () to change the magnification.

×2.0 to ×12.0 : Pressing the Zoom//Q lever once toward Q takes the image straight to the selected magnification and after that magnifies the image in steps.

Off : Pressing the Zoom//Q lever toward Q once magnifies the image in steps in the range of ×1.2 to ×12.0.

4 Press the OK button.

The camera is ready to take or play back images.

Displaying Shooting Information in Playback Mode

Pressing the OK button in Playback mode changes the display format (Display mode) of the image's shooting information.

Norm. (Normal display)

Shooting information is displayed.

- | | |
|---------------------------------------|------------------|
| 1 Voice memo icon | 2 Protect icon |
| 3 Card status | 4 Folder name |
| 5 File name | |
| 6 Four-way controller operation guide | |
| 7 Shooting date and time | |
| 8 Battery level indicator | |
| 9 Aperture | 10 Shutter speed |

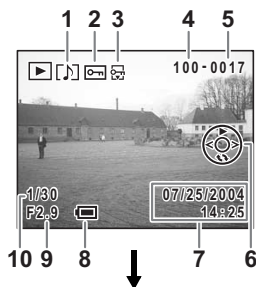

H+inf (Histogram and information)

The brightness distribution of the image is displayed. The horizontal axis of the histogram shows the brightness (darkest at the left end and brightest at the right end) and the vertical axis shows the number of pixels.

- | | |
|-------------------|-----------------|
| 1 Recorded pixels | 2 Quality level |
| 3 White balance | 4 AE metering |
| 5 Sensitivity | 6 Histogram |

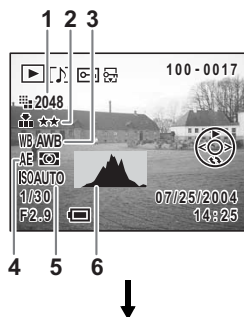

Frame (Frame only and no information)

No shooting information is displayed.



Saving the Display Mode p.84

Norm. (Normal display)

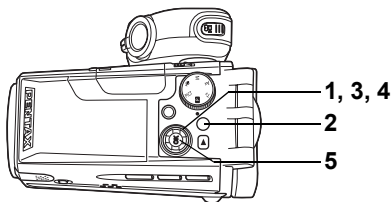

Slideshow

You can play back all the images on the SD Memory Card one after another.

- 1 Enter the Playback mode and use the four-way controller (◀▶) to choose the image with which to start the slideshow.**
- 2 Press the MENU button.**
The [▶ Playback] menu appears.
- 3 Use the four-way controller (▲▼) to select [Slideshow].**
- 4 Use the four-way controller (◀▶) to change the playback interval.**

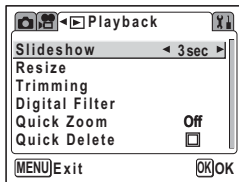

Choose from the following: 3 sec, 5 sec, 10 sec, 15 sec, 20 sec, 30 sec.

- 5 Press the OK button.**

[Start] appears on the LCD monitor and playback starts at the set interval.

Press any button, such as the OK button or MENU button, to stop the slideshow. [Stop] appears on the LCD monitor.



- The slideshow will continue until you press any button.
- Movies and pictures with a voice memo will be played through to the end before the next picture is played back, regardless of the set playback interval.
- Pressing the four-way controller (▶) while playing back a movie or a picture with a voice memo displays the next image.
- Sound files made in Voice Recording mode are not played back.

Playing Back Movies

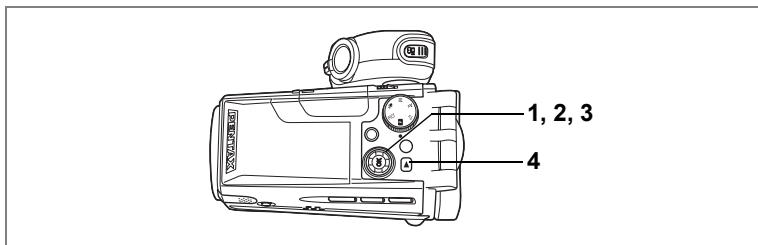

Playing Back Movies

You can play back the movies you have taken. A guide to operation appears on the LCD monitor during playback. Sound is played back at the same time.

- 1 Enter the Playback mode and use the four-way controller (◀▶) to choose a movie to play back.**
- 2 Press the four-way controller (▲).**

Playback starts.

The following operations can be performed during playback.

- | | |
|-------------------------|---|
| Four-way controller (◀) | Reverse playback (fast reverse in every five seconds) |
| Four-way controller (▶) | Forward playback (fast forward in every five seconds) |
| Four-way controller (▲) | Pause |
| Zoom/☒/Q lever (↑) | Increases the volume |
| Zoom/☒/Q lever (↓↓) | Reduces the volume |

The following operations can be performed while Pause is engaged.

- | | |
|-------------------------|--|
| Four-way controller (◀) | Frame reverse (fast reverse 15 frames at a time) |
| Four-way controller (▶) | Frame forward |
| Four-way controller (▲) | Releases the Pause function |

- 3 Press the four-way controller (▼).**
Playback stops and the screen returns to the start screen.
- 4 Press the ▶ button.**
The camera switches to Capture mode.



Viewing Still Pictures and Movies on a TV

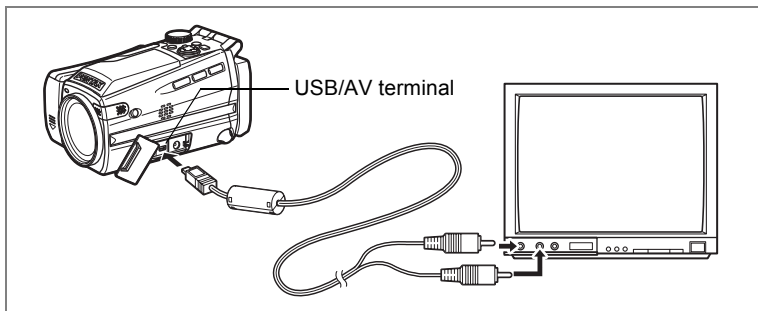

By using the AV cable, you can capture and play back images on a TV or other equipment with a video IN jack. Make sure that both the TV and the camera are turned off before connecting the cable.

1 Open the terminal cover and connect the AV cable to the USB/AV terminal.

2 Connect the other end of the AV cable to the image input terminal and sound input terminal on the TV.

When using stereo sound equipment, insert the sound terminal into the L (white) terminal.

3 Turn the TV and camera on.



- If you intend to use the camera for a long time, use of the AC adapter D-AC7 (optional) is recommended.
- The video output format varies depending on the country or region. If you have any problems displaying the images, check the video output format. Refer to the operating manual for the TV or equipment to which the camera is connected.

Changing the Video Output Format p.129

Deleting

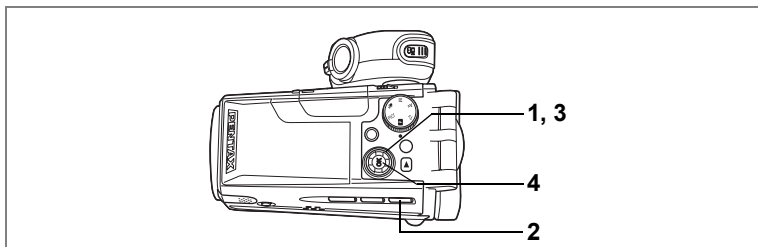

Deleting Single Images and Sound Files

You can delete single images and sound files one at a time.



- Once deleted, images cannot be restored.
- You cannot delete protected images. (p.108)

- 1 Enter the Playback mode and use the four-way controller (◀▶) to choose an image or sound file to delete.**
- 2 Press the button.**
The Delete screen appears.
- 3 Use the four-way controller (▲) to select [Delete].**
- 4 Press the OK button.**
The image or sound file is deleted.

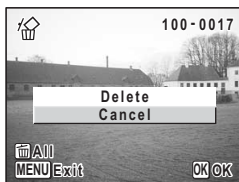

If [Quick Delete] is set to (On) in the [▶] Playback menu, Step 3 can be omitted. (p.106)

Deleting Voice Memos Only

If an image has a voice memo, you can delete the voice memo without deleting the image.

- 1 Enter the Playback mode and use the four-way controller (◀▶) to choose an image with a voice memo to delete.**
- 2 Press the  button.**
The Delete screen appears.
- 3 Use the four-way controller (▲▼) to select [Sound Delete].**
- 4 Press the OK button.**
The voice memo is deleted.



Select [Delete] in Step 3 above to delete both the image and the voice memo.

Setting the Quick Delete Function

When the Quick Delete function is set to (On), the Delete screen appears with [Delete] already highlighted.

- 1 Press the MENU button in Playback mode.**
The [▶ Playback] menu appears.
- 2 Use the four-way controller (▲▼) to select [Quick Delete].**
- 3 Use the four-way controller (◀▶) to select (On) or (Off).**
- 4 Press the OK button.**
The camera is ready to take or play back images.

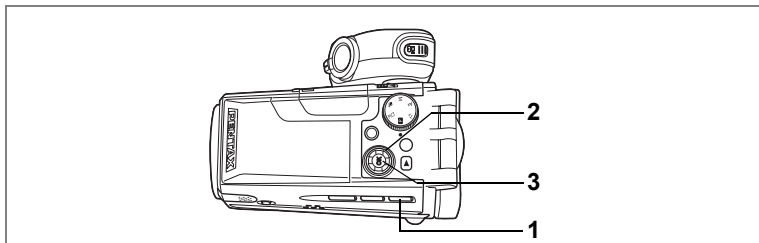



Deleting All Images

You can delete all the images and sound files at once.



- Once deleted, images cannot be restored.
- Protected images and sound files cannot be deleted.

- 1 Press the  button twice in Playback mode.**
The Delete All screen appears.
- 2 Use the four-way controller () to select [Delete All].**
- 3 Press the OK button.**
All the images and sound files are deleted.



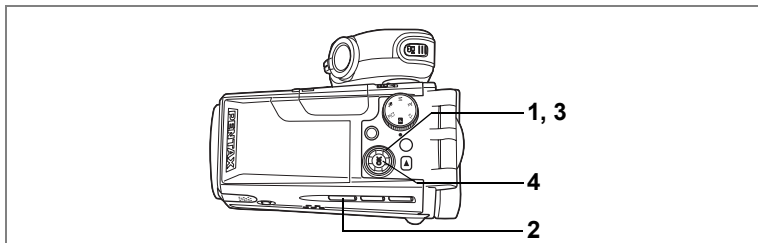

Protecting Images and Sound Files from Deletion (Protect)

You can protect images and sound files from being accidentally deleted.

1 Enter the Playback mode and use the four-way controller (◀▶) to choose an image or sound file to protect.

2 Press the  button.
The Protect screen appears.

3 Use the four-way controller (▲) to select [Protect].

4 Press the OK button.
The selected images are protected.

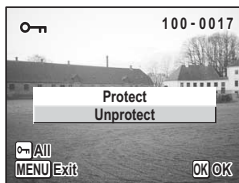

- To cancel the Protect setting, select [Unprotect] in Step 3.
-  appears on protected images or sound files during playback.

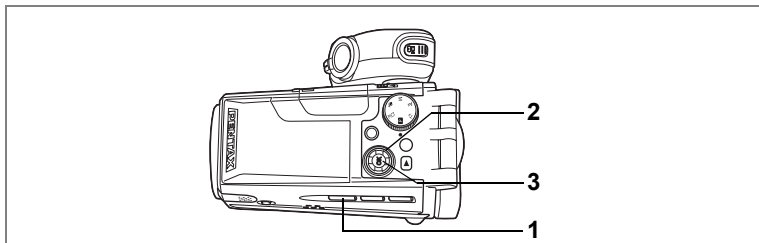

Protecting All Images and Sound Files

You can protect all your images and sound files.

- 1 Press the  button twice in Playback mode.**

The Protect All screen appears.

- 2 Use the four-way controller () to select [Protect all].**

- 3 Press the OK button.**

All the images and sound files are protected.



To cancel the Protect setting on all your images and sound files, select [Unprotect] in Step 2.



Protected images and sound files will be deleted when the SD Memory Card is formatted.

Editing Still Pictures

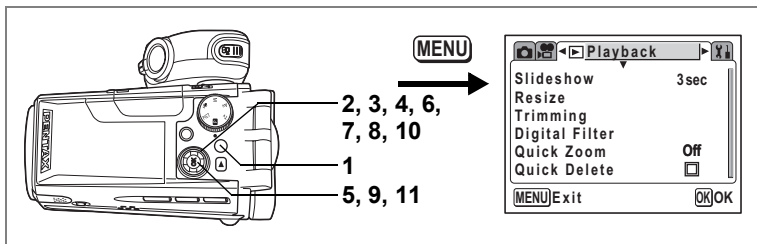

Changing the Image Size and Quality (Resize)

By changing the size and quality of a selected image, you can make the file smaller than the original. You can use this function to continue taking pictures when the SD Memory Card is full, by making the images smaller and overwriting the original images to make more space available in the memory.

- 1 Press the MENU button in Playback mode.**
The [▶ Playback] menu appears.
- 2 Use the four-way controller (▲▼) to select [Resize].**
- 3 Press the four-way controller (▶).**
The Resize screen appears.

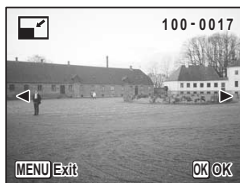

- 4 Use the four-way controller (◀▶) to choose an image to resize.**
- 5 Press the OK button.**
The screen for selecting the resolution and quality appears.

- 6 Use the four-way controller (◀▶) to change the number of recorded pixels.
- 7 Press the four-way controller (▼). The frame moves to [Quality Level].
- 8 Use the four-way controller (◀▶) to change the quality.
- 9 Press the OK button.
- 10 Use the four-way controller (▲▼) to select [Overwrite] or [Save as].
- 11 Press the OK button. The resized image is saved.



- Movies cannot be resized.
- You cannot select a larger size than that of the original image.

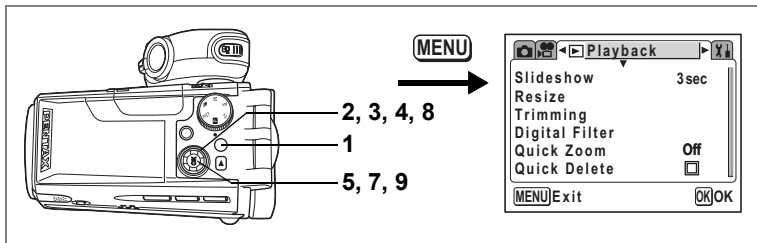

Trimming Images

You can trim part of a picture and save it as a separate image.

- 1 Press the MENU button in Playback mode.**
The [▶ Playback] menu appears.
- 2 Use the four-way controller (▲▼) to select [Trimming].**
- 3 Press the four-way controller (▶).**
Images that can be trimmed appear.
- 4 Use the four-way controller (◀▶) to choose an image.**
- 5 Press the OK button.**
The Trimming screen appears.
- 6 Choose the trimming conditions.**
Operations that can be performed on the Trimming screen

Zoom/☒/Q lever	Changes the size of the trimmed section
Four-way controller (▲▼◀▶)	Moves the trimming position up, down, left and right
MENU button	Returns to the image selection screen
- 7 Press the OK button.**
- 8 Use the four-way controller (▲▼) to select [Overwrite] or [Save as].**
- 9 Press the OK button.**
The trimmed image is saved.

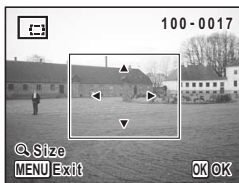

- Movies cannot be trimmed.
- The image is saved according to the trimming size.

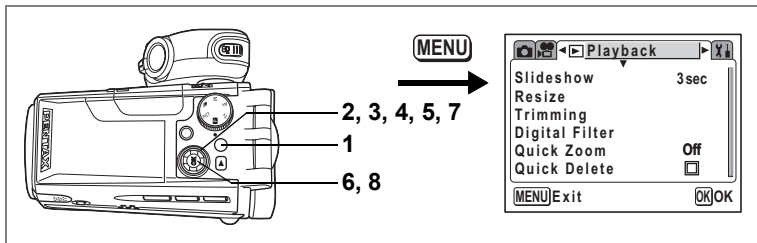

Editing Pictures with Digital Filters

The digital filters consist of eight color filters: B&W, Sepia, Red, Pink, Purple, Blue, Green and Yellow. The Digital Filter mode enables you to edit pictures using these filters. When the special filter effect has been created, the image appears on the LCD monitor and is saved.

1 Press the MENU button in Playback mode.

The [▶ Playback] menu appears.

2 Use the four-way controller (▲▼) to select [Digital Filter].

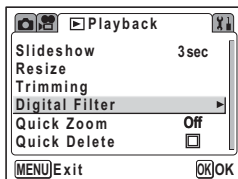

3 Press the four-way controller (▶).

Images that can be edited with the digital filters appear.

4 Use the four-way controller (◀▶) to choose an image.

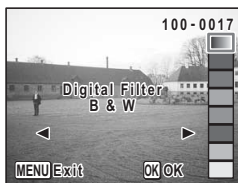

5 Use the four-way controller (▲▼) to choose a digital filter.

6 Press the OK button.

7 Use the four-way controller (▲▼) to select [Overwrite] or [Save as].

8 Press the OK button.

The image is saved with the digital filter effect.



Setting the Printing Service (DPOF)

You can print the images on the SD Memory Card using a DPOF (Digital Print Order Format) compatible printer or photo processing lab.

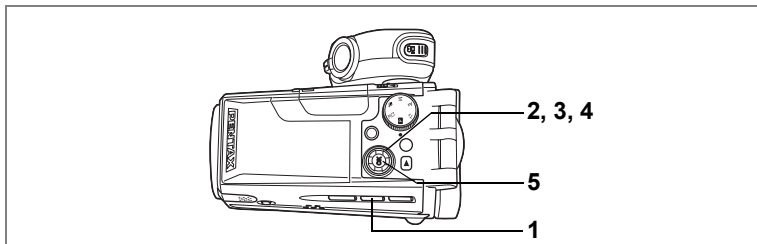

Printing Single Images

Set the following items for each image.

Copies : Choose the number of copies up to 99.

Date : Specify whether you want the date inserted on the print or not.

1 Press the DPOF button in Playback mode.

2 Use the four-way controller (◀▶) to choose an image to print and press the four-way controller (▼).

The frame moves to [Copies].

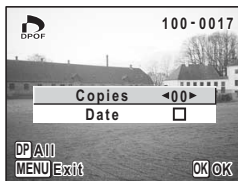

3 Use the four-way controller (◀▶) to choose the number of copies and press the four-way controller (▼).

The frame moves to [Date].



4 Use the four-way controller (◀▶) to choose whether to insert the date or not.

- (On) : The date will be imprinted.
- (Off) : The date will not be imprinted.

5 Press the OK button.

The print settings are made accordingly.



- If DPOF settings have already been made for an image, the previous number of copies and date setting will be displayed.
- To cancel DPOF settings, set the number of copies to [0] and press the OK button.



- You cannot set the printing service for movies or sound-only files.
- Depending on the printer or printing equipment at the photo processing lab, the date may not be imprinted on the pictures even if the DPOF setting was made.

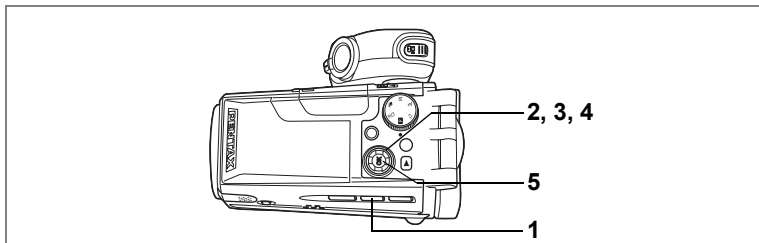

Printing All Images

1 Press the DPOF button twice in Playback mode.

2 Use the four-way controller (◀▶) to choose the number of copies.

You can print up to 99 copies.

3 Press the four-way controller (▼).

The frame moves to [Date].

4 Use the four-way controller (◀▶) to choose whether to insert the date or not.

(On) : The date will be imprinted.

(Off) : The date will not be imprinted.

5 Press the OK button.

The print settings are made accordingly.



The number of copies specified in the DPOF settings applies to all the images. Before printing, check that the number is correct.



- Settings for single images are cancelled when settings are made for all images.
- DPOF settings are not possible for movies or sound only files.

Direct Printing Using PictBridge

By connecting the camera to a PictBridge-compatible printer using the USB cable (I-USB17) supplied with the camera, you can print images directly from the camera without using a PC. Connect the camera to the printer and select the images you want to print and the number of copies.

Caution:

- You are recommended to use the AC adapter D-AC7 (optional) while the camera is connected to the printer. The printer may not work properly or the image data may be damaged if the battery runs out of power while the camera is connected to the printer.
- Do not disconnect the USB cable during data transfer.
- Depending on the type of printer, not all the settings made on the camera (such as image quality and DPOF settings) may be valid.
- Pictures may not be printed correctly when the camera is connected directly to a PictBridge-compatible printer if the number of copies exceeds 500.
- You cannot choose the print size with the camera. Use the printer to choose the size. For more information, refer to the operating manual for your printer.

Connecting the Camera to the Printer

1 Select [PictBridge] for [USB Connection] on the [⌘ Set-up] menu.

Refer to “Changing the USB Connection Mode” (p.130).

2 Connect the camera to the printer using the USB cable supplied with the camera.

The PictBridge menu appears.



Caution:

Do not connect the camera to your PC while [PictBridge] is selected for the USB Connection mode.

Printing Single Images

- 1 Use the four-way controller (▲▼) to select [Print One] on the PictBridge menu.**



- 2 Press the OK button.**

The Print One screen appears.

- 3 Use the four-way controller (◀▶) to choose an image to print.**

- 4 Use the four-way controller (▲▼) to choose the number of copies.**

You can print up to 99 copies.



- 5 Use the  button to choose whether to insert the date or not.**

(On) : The date will be imprinted.

(Off) : The date will not be imprinted.

- 6 Press the OK button.**

The image is printed according to the settings.

To cancel printing operation, press the MENU button.

Printing All Images

- 1 Use the four-way controller (▲▼) to select [Print All] on the PictBridge menu.**
- 2 Press the OK button.**

The Print All screen appears.
- 3 Use the four-way controller (▲▼) to choose the number of copies.**

The number of copies you choose applies to all the images.
- 4 Use the  button to choose whether to insert the date or not.**
 - (On) : The date will be imprinted.
 - (Off) : The date will not be imprinted.
- 5 Press the OK button.**

All the images are printed according to the settings.
To cancel printing operation, press the MENU button.



Printing Images Using the DPOF Settings

- 1 Use the four-way controller (▲▼) to select [DPOF AUTOPRINT] on the PictBridge menu.**
- 2 Press the OK button.**

The Print w/DPOF Settings screen appears.
Use the four-way controller (◀▶) to check the images and print settings.
- 3 Press the OK button.**

The selected images are printed according to the DPOF settings.
To cancel printing operation, press the MENU button.

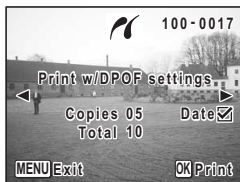

The self-timer lamp lights during printing to show that the image data is being transferred to the printer.

Disconnecting the Camera from the Printer

Disconnect the camera from the printer when you have finished printing.

- 1 Disconnect the USB cable from the camera.**
- 2 Disconnect the USB cable from the printer.**



The camera automatically turns off when the USB cable is disconnected.

Camera Settings

How to recall the [Y/↓ Set-up] menu

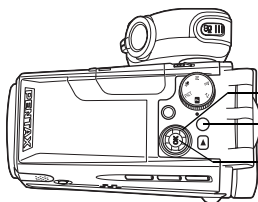

Four-way controller
MENU button
OK button

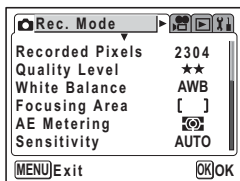

Formatting an SD Memory Card

Formatting will delete all the data on the SD Memory Card.



- Do not remove the SD Memory Card while the card is being formatted as this may damage the card and render it unusable.
- SD Memory Cards formatted on a PC or device other than the camera cannot be used. Be sure to format the card with the camera.
- Formatting will delete protected data too.

1 Select [Format] on the [Y/↓ Set-up] menu.

2 Press the four-way controller (▶).

The Format screen appears.

3 Use the four-way controller (▲▼) to select [Format].

4 Press the OK button.

Formatting starts. When formatting is completed, the camera is ready to take pictures.

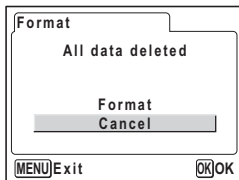

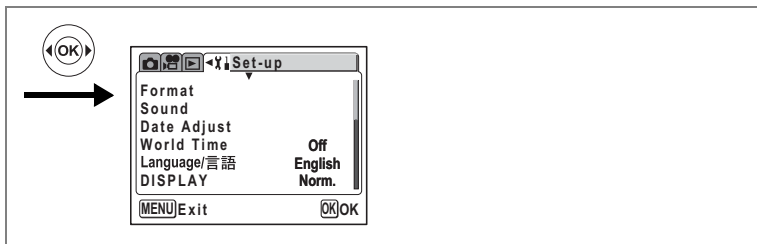

Changing the Sound Settings

You can adjust the playback volume and the volume of operation sounds, such as the start-up sound, shutter sound and key operation sound. You can also change the type of sound.

Changing the Playback Volume and Operation Volume

- 1 Select [Sound] on the [Set-up] menu.**
- 2 Press the four-way controller (▶).**
The Sound screen appears.
- 3 Use the four-way controller (▲▼) to select [Playback Volume] or [Operation Vol.].**
- 4 Use the four-way controller (◀▶) to adjust the volume.**
- 5 Press the OK button twice.**
The camera is ready to take or play back images.

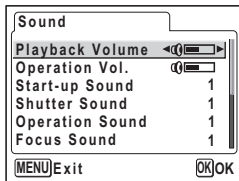

Changing the Sound Type

- 3 Use the four-way controller (▲▼) to select [Start-up Sound].**
- 4 Use the four-way controller (◀▶) to select [Off], [1], [2] or [3].**
Set the [Shutter Sound], [Operation Sound], [Focus Sound] and [Self-timer Sound] in the same way.
- 5 Press the OK button twice.**
The camera is ready to take or play back images.



The Sound settings are saved when the camera is turned off.

How to recall the [M] Set-up] menu

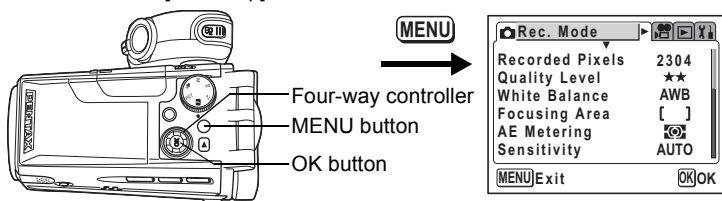

Changing the Date and Time

You can change the initial date and time settings. You can also set the style in which the date appears on the camera. Choose [mm/dd/yy], [dd/mm/yy] or [yy/mm/dd].

1 Select [Date Adjust] on the [M] Set-up] menu.

2 Press the four-way controller (▶).

The Date Adjust screen appears.

Refer to “Setting the Date and Time” (p.30) for the setting procedure.

Setting the World Time

The date and time selected in “Setting the Date and Time” (p.30) serve as the Home Time setting.

You can display the time in a city other than the Home Time city (World Time). This is useful when taking pictures abroad.

1 Select [World Time] on the [M] Set-up] menu.

2 Press the four-way controller (▶).

The World Time screen appears.

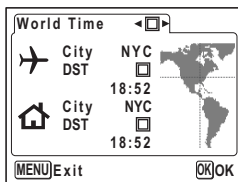

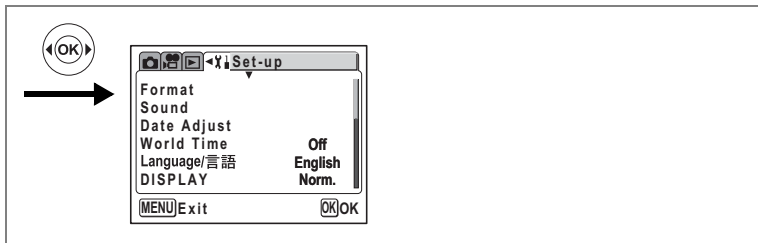

- 3 Use the four-way controller (◀▶) to select (On) or (Off).**

 - : The time in the city selected in World Time is displayed.
 - : The time in the city selected in Home Time is displayed.
- 4 Press the four-way controller (▼).**

If New York is selected as the World Time city, the location of New York is marked on the world map and ↗ indicates the current time in New York (NYC).
- 5 Use the four-way controller (◀▶) to select the ↗ (World Time) city and press the four-way controller (▼).**
- 6 Use the four-way controller (◀▶) to turn [DST] (On) or (Off) and press the four-way controller (▼).**

The frame moves to ↗ (Home Time) city.
 The default setting for the ↗ (Home Time) city is [NYC (New York)].
 Use the four-way controller (◀▶) to change the ↗ (Home Time) city and choose the DST setting.
- 7 Press the OK button twice.**

The camera is ready to take or play back images with the time in the selected city.



Refer to p.134 for the list of cities and code names.

How to recall the [Set-up] menu

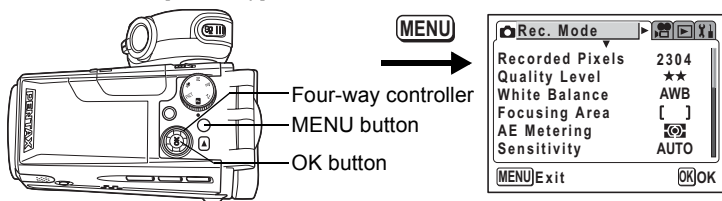

Changing the Display Language

You can change the language in which the menus, error messages, etc. are displayed.

You can choose from English, French, German, Spanish, Italian, Russian, Korean, Chinese (traditional and simplified) and Japanese.

1 Select [Language/言語] on the [Set-up] menu.

2 Press the four-way controller (▶).
The Language/言語 screen appears.

3 Use the four-way controller (▲▼) to choose a language.

4 Press the OK button twice.
The camera is ready to take or play back images.



Changing the Display Mode

You can change the information displayed on the LCD monitor during shooting or playback.

1 Select [DISPLAY] on the [Set-up] menu.

2 Use the four-way controller (▲▼) to select [Norm.], [H+inf], [Grid] or [Frame].

Refer to p.66 and p.101 for details of each display mode.

Norm. : Normal display

H+inf : Histogram and information

Grid : Grid display or Normal display in Playback mode

Frame : Frame only and no information

3 Press the OK button.

The camera is ready to take or play back images.



You cannot change the information displayed on the LCD monitor while playing back a movie.

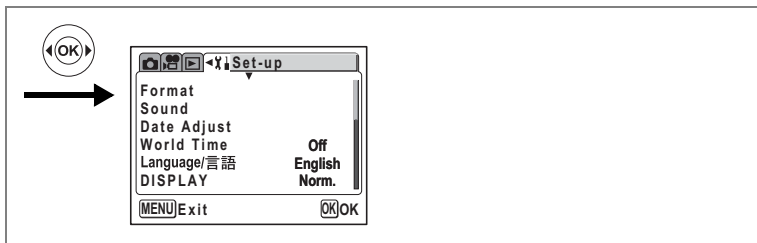

Changing the Background Color and Screen Effects

- 1 Select [Screen Setting] on the [Set-up] menu.**
- 2 Press the four-way controller (▶).**
The Screen Setting screen appears.

Using Screen Effects

Selecting (On) lets you display various animated effects when you change the image displayed on the LCD monitor.

- 3 Use the four-way controller (▲▼) to select [Screen effect].**
- 4 Use the four-way controller (◀▶) to select (On) or (Off).**
- 5 Press the OK button twice.**
The camera is ready to take or play back images.

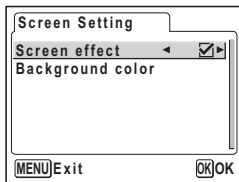

Changing the Background Color

You can choose the background color of the menus displayed on the LCD monitor.

- 3 Use the four-way controller (▲▼) to select [Background color].**
- 4 Use the four-way controller (▶) to open the sub menu and choose a background color with the four-way controller (▲▼◀▶).**
- 5 Press the OK button twice.**
The camera is ready to take or play back images.

How to recall the [Set-up] menu

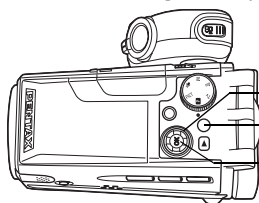

MENU

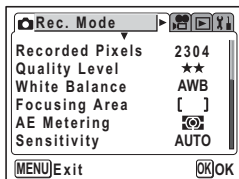

Adjusting the Brightness of the LCD Monitor

You can adjust the brightness of the LCD monitor.

1 Select [Brightness Level] on the [Set-up] menu.

2 Press the four-way controller (▶).

The Brightness Level screen appears.

3 Use the four-way controller (◀▶) to adjust the brightness.

The monitor gets darker as the bar slider moves to the left and brighter as it moves to the right.

4 Press the OK button twice.

The camera is ready to take or play back images.

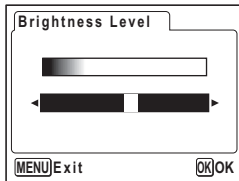

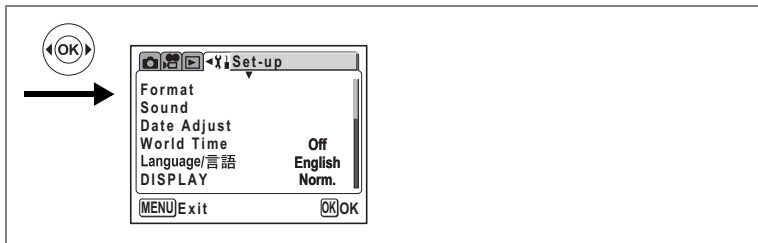

Changing the Video Output Format

You can choose the output format (NTSC or PAL) for taking or playing back images on a TV.

- 1 Select [Video Out] on the [X] Set-up] menu.**
- 2 Use the four-way controller (◀▶) to select [NTSC] or [PAL].**

Choose the video output format to match the output format of the TV.

- 3 Press the OK button.**

The camera is ready to take or play back images.

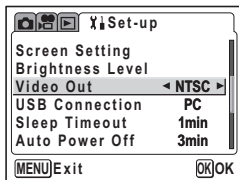

NTSC is the video output format used in North America.

Viewing Still Pictures and Movies on a TV p.104

How to recall the [Y/Menu] Set-up] menu

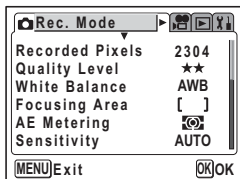
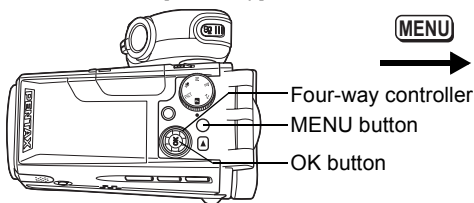

Changing the USB Connection Mode

Choose the appropriate USB connection mode depending on whether you are going to connect the USB cable to a printer or a computer.

- 1 Select [USB Connection] on the [Y/Menu] Set-up] menu.
- 2 Use the four-way controller (◀▶) to select [PC], [PictBridge] or [PC-F].

[PictBridge]: Select this option when connecting the camera directly to a PictBridge-compatible printer.

[PC] : Select this option when connecting the camera to a computer.

[PC-F] : Select this option if data transfer does not work properly when [PC] has been selected.

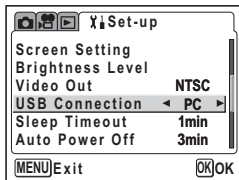

- 3 Press the OK button.

The camera is ready to be connected to the computer or printer.



- Do not connect the camera to your PC while [PictBridge] is selected for the USB Connection mode.
- Do not connect the camera to the printer while [PC] or [PC-F] is selected for the USB Connection mode.



- Refer to the “PC Connection Manual - Enjoying Your Digital Camera Images On Your PC” for instructions on connecting the camera to a computer.
- Depending on the connecting condition of PC and the camera, images or other data may not be transferred properly. If this happens, select [PC-F]. (Data transfer is fixed at USB full speed when [PC-F] has been selected.)

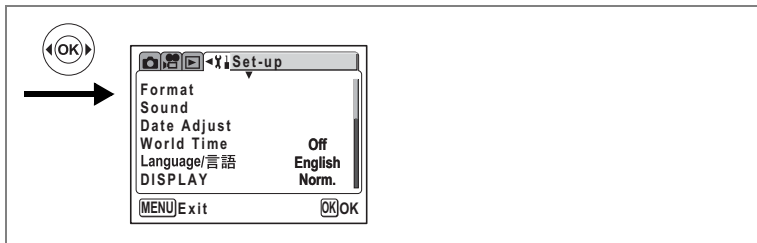

Setting Sleep Timeout

You can set the LCD monitor to turn off automatically when no operation is performed for a fixed time. Pressing any button other than the power switch during Sleep Timeout will turn the LCD monitor back on.

- 1 Select [Sleep Timeout] on the [] Set-up] menu.
- 2 Use the four-way controller (◀▶) to select [30sec], [1min], [2min] or [Off].
- 3 Press the OK button.

The camera is ready to take or play back images.



The Sleep Timeout function will not work during a slideshow or movie playback.

Setting Auto Power Off

You can set the camera to turn off automatically when no operation is performed for a fixed time.

- 1 Select [Auto Power Off] on the [] Set-up] menu.
- 2 Use the four-way controller (◀▶) to select [3min], [5min] or [Off].
- 3 Press the OK button.

The camera is ready to take or play back images.



The Auto Power Off function will not work during a slideshow or movie playback.

How to recall the [M] Set-up] menu

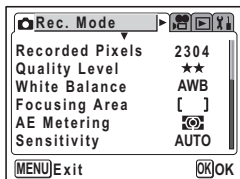
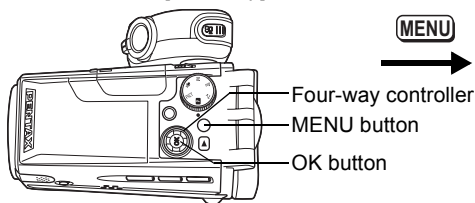

Registering a Function on the OK Button

You can register the display mode or digital filters for still pictures on the OK button. The default setting is the display mode.

- 1 Select [OK Button] on the [M] Set-up] menu.**
- 2 Use the four-way controller (◀▶) to select [DISP.], [FILT.] or [NON].**
- 3 Press the OK button.**

The camera is ready to take or play back images.

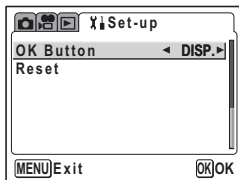

Displaying Shooting Information in Capture Mode
p.66

Displaying Shooting Information in Playback Mode
p.101

Taking Pictures with Color Filters p.56

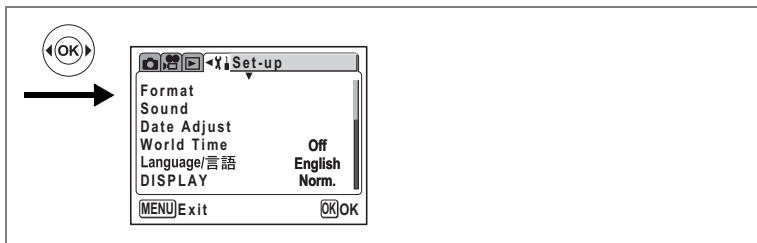

Resetting to Default Settings (Reset)

You can reset all the settings other than the Date Adjust, Language/言語 and World Time.

- 1 Select [Reset] on the [Y] Set-up menu.**
- 2 Press the four-way controller (▶).**
The Reset screen appears.
- 3 Use the four-way controller (▲) to select [Reset].**
- 4 Press the OK button.**
The camera is ready to take or play back images.

List of City Codes

Refer to the following list of city codes when setting the World Time.

TYO	Tokyo	JNB	Johannesburg
GUM	Guam	IST	Istanbul
SYD	Sydney	CAI	Cairo
NOU	Noumea	JRS	Jerusalem
WLG	Wellington	MOW	Moscow
AKL	Auckland	JED	Jeddah
PPG	Pago Pago	THR	Tehran
HNL	Honolulu	DXB	Dubai
ANC	Anchorage	KHI	Karachi
YVR	Vancouver	KBL	Kabul
SFO	San Francisco	MLE	Male
LAX	Los Angeles	DEL	Delhi
YYC	Calgary	CMB	Colombo
DEN	Denver	KTM	Kathmandu
MEX	Mexico City	DAC	Dacca
CHI	Chicago	RGN	Rangoon
MIA	Miami	BKK	Bangkok
YTO	Toronto	KUL	Kuala Lumpur
NYC	New York	VTE	Vientiane
SCL	Santiago	SIN	Singapore
CCS	Caracas	PNH	Phnom Penh
YHZ	Halifax	SGN	Ho Chi Minh
BUE	Buenos Aires	JKT	Jakarta
SAO	Sao Paulo	HKG	Hong Kong
RIO	Rio de Janeiro	PER	Perth
MAD	Madrid	BJS	Beijing
LON	London	SHA	Shanghai
PAR	Paris	MNL	Manila
MIL	Milan	TPE	Taipei
ROM	Rome	SEL	Seoul
BER	Berlin	ADL	Adelaide

Optional Accessories

A number of dedicated accessories are available for this camera.

Wide angle conversion lens L-WC17 (p.65)

AC adapter D-AC7

Rechargeable lithium-ion battery D-LI7 (*)

Battery charger D-BC7 (*)

AC plug cord D-CO2 (*)

D-CO2A Australia

D-CO2B United Kingdom

D-CO2E Europe

D-CO2H Hong Kong

D-CO2J Japan

D-CO2K Korea

D-CO2U North America, Canada

USB cable I-USB17 (*)

AV cable I-AVC7 (*)

Strap O-ST17 (*)

Camera case O-CC17

Products marked with an asterisk (*) are the same as those supplied with the camera.

Messages

Messages such as the following may appear on the LCD monitor during camera operation.













No image & sound	There are no image/sound files on the SD Memory Card.
Memory card full	The SD Memory Card is full and no more images can be saved. Insert a new SD Memory Card or delete unwanted images. (p.18, 105) Change the quality/size and try again. (p.110)
Memory card error	Shooting and playback are impossible due to a problem with the SD Memory Card. It may work on your PC.
Card not formatted	The SD Memory Card you have inserted is unformatted or has been formatted on a PC or other device and is not compatible with this camera. (p.122)
Card locked	The SD Memory Card is write-protected. (p.19)
Data being recorded	The image is being recorded on the SD Memory Card. The protect setting or DPOF setting is being changed. The movie is being recorded.
Camera cannot replay this image/sound	You are trying to play back an image or sound file in a format not supported by this camera. You may be able to play it back on another brand of camera or PC.
Deleting	The image is being deleted.
Battery depleted Can not save image	The battery is exhausted. Replace with a new battery. If using a rechargeable battery, charge the battery. (p.15)
Formatting...	The SD Memory Card is being formatted.
Image folder could not be created	The largest file number has been assigned to an image in the largest folder number and no more images can be saved. Insert a new SD Memory Card or format the SD Memory Card. (p.122)
Image & sound protected	The image or sound file you are trying to delete is protected.

Messages such as the following may appear on the LCD monitor when using the PictBridge function.

No paper	There is no paper in the printer.
No ink	There is no ink in the printer.
Printer error	An error message has been sent from the printer.
Data error	A data error message has been sent from the printer.
Paper stuck	The paper in the printer has stuck.

Troubleshooting

Problem	Cause	Remedy
Camera will not turn on	Battery is not installed	Check battery is installed. If not, install battery.
	Battery is installed incorrectly	Check orientation of battery. Reinsert battery according to the ⊕ ⊖ symbols on the battery compartment. (p.15)
	Battery power is low	Insert a new or charged battery or use the AC adapter.
	AA batteries have been inserted	AA batteries cannot be used in this camera. Use a D-LI7 battery.
No image on the LCD monitor	Camera is connected to a PC by the USB cable	LCD monitor is off when camera is connected to a PC.
	Camera is connected to a TV	LCD monitor is off when camera is connected to a TV.
	Image is displayed but is hard to see	Image on LCD monitor may be hard to see when taking pictures outside in sunlight.
Shutter will not release	Flash is charging	Pictures cannot be taken while the flash is charging. Wait until charging is finished.
	No available space on SD Memory Card	Insert SD Memory Card with available space or delete unwanted images. (p.18, 105)
	Recording	Wait until recording is finished.
Picture is dark	Subject is too far away in a dark environment, such as a night scene	Picture becomes dark if subject is too far away. Take picture within range of flash.
	Background is dark	When taking a picture of a person against a dark background, such as a night scene, the person may appear dark if the flash does not reach the background even with the correct exposure. Set to  in Picture mode to ensure both person and background are clear. (p.50)

Problem	Cause	Remedy
Subject is not in focus	Subject difficult to focus on	Subjects difficult to focus on using autofocus: objects with little contrast (blue sky, white walls, etc.), dark objects, finely patterned objects, fast-moving objects, scenery through window or net, etc. Lock focus on another object located at same distance (press shutter release button halfway), then aim at target and press shutter release button fully, or use Manual Focus mode.
	Subject is not in focusing area	Position subject in focus frame (focusing area) in middle of LCD monitor. If the subject is outside the focusing area, aim the camera at the subject and lock the focus (press shutter release button halfway), then compose picture and press the shutter release button fully.
	Subject is too close	Set focus mode on  (Macro) or  (Super Macro). (p.68)
	Focus mode is set on  or 	Normal pictures will be out of focus if taken with focus mode set on  (Macro) or  (Super Macro).
Flash does not discharge	Flash is not open	Press  OPEN to make flash pop up.
	Flash mode is set to Off	Set to Auto or  . (p.70)
	<ul style="list-style-type: none"> • Capture mode is set to Movie mode • Drive mode is set to  or  • Focus mode is set to  or  	Flash will not discharge in these modes.
Zoom will not work	Focus mode is set to 	Zoom does not function in Super Macro mode.
USB connection with computer does not work properly	USB Connection mode is set to PictBridge	Set USB Connection mode on camera to [PC]. (p.130)
	USB data transfer has failed	Set USB Connection mode on camera to [PC-F]. (p.130)

Main Specifications

Type	Fully automatic compact digital still camera with built-in zoom lens		
Effective Pixels	4.0 megapixels		
Sensor	4.23 megapixels (total pixels) 1/2.7 inch interline transfer CCD with primary color filter		
Recorded Pixels	Still Picture	2304×1728 pixels, 1600×1200 pixels, 1024×768 pixels, 640×480 pixels	
	Movie	640×480 pixels, 320×240 pixels, 160×120 pixels	
Sensitivity	Auto, manual (100/200/400: Standard Output Sensitivity)		
File Format	Still Picture	JPEG (Exif2.2), DCF, DPOF, PictBridge, PRINT Image Matching III	
	Movie	MOV (MPEG4), streaming video, approx. 30fps, approx. 15fps, with sound (PCM system, monaural)	
	Sound	Voice memo, voice recording: WAVADPCM system, monaural	
Quality Level	Still Picture	★★★ "Best", ★★ "Better", ★ "Good"	
	Movie	★★★ "Best", ★★ "Better", ★ "Good"	
Storage Medium	SD Memory Card		

Image Storage Capacity and Recording Time (when using a 64MB SD Memory Card)

Still Picture (approximate number of images)

Recorded Pixels	Quality Level		
	★★★ Best	★★ Better	★ Good
2304 (2304×1728)	24	47	69
1600 (1600×1200)	51	89	123
1024 (1024×768)	112	202	257
640 (640×480)	241	386	483

Movie (approximate recording time)

Recorded Pixels	Quality Level		
	★★★ Best	★★ Better	★ Good
640 (640×480)	2.5 min. (5 min.)	4 min. (7 min.)	5 min. (9 min.)
320 (320×240)	6 min. (11 min.)	9 min. (16 min.)	16 min. (25 min.)
160 (160×120)	16 min. (25 min.)	20 min. (31 min.)	31 min. (42 min.)

Frame rate: 30fps (15fps)

Sound

Approx. 4 hr. 22 min.

White Balance	Auto, Daylight, Shade, Tungsten Light, Fluorescent Light, Manual		
Lens	Focal Length	5.8 mm – 58 mm (equivalent to 37 mm – 370 mm in 35 mm format)	
	Maximum Aperture	f2.9 – f3.5	
	Lens Composition	12 elements in 8 groups (1 double-sided aspheric lens, 1 single-sided aspheric lens)	
	Zoom Type	Electrically driven	
	Picture Range	21.2 mm×15.5 mm (screen is filled) (Super Macro mode) With filter screw (37 mm) and lens cap	
Digital Zoom	Capture Mode	Max. 10× (combines with 10× optical zoom to give zoom magnification equivalent to 100×)	
LCD Monitor	1.8 inch CG silicon TFT color LCD monitor (microreflective), with brightness adjustment, approx. 134 kilopixels (with backlight), with swivel mechanism (210° vertically and 180° horizontally)		

Playback Functions	Single-frame, 9-frame index, enlargement (max. 12×, scroll), slideshow, resizing, trimming, movie playback, histogram display, rotating, digital filter					
Autofocus	Type	TTL contrast detection system by sensor 5-point autofocus (multi/spot changeable)				
	Focusing Range (from lens front)	When Taking Still Pictures		When Taking Movies		
			Wide	Tele	Wide	Tele
		Autofocus (Normal)	0.4m – ∞	1.2m – ∞	0.1m – ∞	1.2m – ∞
		Macro	0.1m – 0.5m	0.6m – 1.5m	0.1m – ∞	1.2m – ∞
Super Macro		0cm – 15cm	–	0.1m – ∞	1.2m – ∞	
	Landscape	∞	∞	∞	∞	
	Focus Lock	By half-pressing shutter release button				
Manual Focus	0 cm – ∞ (Wide), 60 cm – ∞ (Tele)					
Exposure Mechanism	AE Metering	TTL metering by sensor (multi-segment, center-weighted, spot)				
	EV Compensation	±2 EV (can be set in 1/4 EV steps)				
	Capture Modes	Picture Mode, Program, Shutter-Priority, Aperture-Priority, Manual				
Picture Mode	Landscape, Flower, Portrait, Sport, Surf&Snow, Sunset, Night Scene, Soft, Illustration, Panorama					
Digital Filters	B&W, Sepia, Red, Pink, Purple, Blue, Green, Yellow					
Autobricket	Exposure, White Balance, Saturation, Sharpness, Contrast					
Movie	Continuous recording time	Approx. 120 min. max. (depending on SD Memory Card capacity)				
Shutter	Type	Electronic/mechanical shutter				
	Speed	Approx. 1/2000 sec. – 4 sec. (Manual Exposure, Shutter Priority: Approx. 1/1000 sec. – 4 sec.)				
Flash	Type	Retractable flash with red-eye reduction function				
	Flash Modes	Auto (at low illumination), Flash Off, Flash On, Auto + Red-eye Reduction, Flash On + Red-eye Reduction				
	Working Range	Wide : approx. 0.1 m – 5.1 m (equivalent to ISO 200) Tele : approx. 0.6 m – 3.8 m (equivalent to ISO 200)				
Drive Modes	Single-frame, Continuous, High-Speed Continuous, 10-sec. Self-timer, 2-sec. Self-timer, Autobricket (Exposure, White Balance, Saturation, Sharpness, Contrast)					
Self-Timer	Electronic control type, control time: approx. 10 sec., 2 sec.					
Time Function	World Time setting for 62 cities (28 time zones)					
Power Supply	D-Li7 lithium-ion battery, AC adapter (optional)					
Battery Life (Image storage capacity)	Approx. 180 pictures	(at 23°C, flash fired for 50% of shots with fully charged D-Li7 lithium-ion battery, in accordance with CIPA measuring conditions)				
In/Out Port	USB/AV terminal (PC communication type USB 2.0), external power supply terminal					
Video Output Format	NTSC/PAL (monaural)					
PictBridge	Printer	PictBridge-compatible printer				
	Print Modes	Print One, Print All, DPOF AUTOPRINT				
Size	73 (W)×59 (H)×103.5 (D) mm (excluding operating members)					
Weight	330 g (excluding battery and SD Memory Card)					
Weight When Shooting	375 g (including D-Li7 battery and SD Memory Card)					
Accessories	Rechargeable lithium-ion battery, battery charger, AC plug cord, SD Memory Card, USB cable, AV cable, software (CD-ROM), strap, lens cap, operating manual					

WARRANTY POLICY

All PENTAX cameras purchased through authorized bona fide photographic distribution channels are guaranteed against defects of material or workmanship for a period of twelve months from date of purchase. Service will be rendered, and defective parts will be replaced without cost to you within that period, provided the equipment does not show evidence of impact, sand or liquid damage, mishandling, tampering, battery or chemical corrosion, operation contrary to operating instructions, or modification by an unauthorized repair shop. The manufacturer or its authorized representatives shall not be liable for any repair or alterations except those made with its written consent and shall not be liable for damages from delay or loss of use or from other indirect or consequential damages of any kind, whether caused by defective material or workmanship or otherwise; and it is expressly agreed that the liability of the manufacturer or its representatives under all guarantees or warranties, whether expressed or implied, is strictly limited to the replacement of parts as hereinbefore provided. No refunds will be made on repairs by non-authorized PENTAX service facilities.

Procedure During 12-month Warranty Period

Any PENTAX which proves defective during the 12-month warranty period should be returned to the dealer from whom you purchased the equipment or to the manufacturer. If there is no representative of the manufacturer in your country, send the equipment to the manufacturer, with postage prepaid. In this case, it will take a considerable length of time before the equipment can be returned to you owing to the complicated customs procedures required. If the equipment is covered by warranty, repairs will be made and parts replaced free of charge, and the equipment will be returned to you upon completion of servicing. If the equipment is not covered by warranty, regular charges of the manufacturer or of its representatives will apply. Shipping charges are to be borne by the owner. If your PENTAX was purchased outside of the country where you wish to have it serviced during the warranty period, regular handling and servicing fees may be charged by the manufacturer's representatives in that country. Notwithstanding this, your PENTAX returned to the manufacturer will be serviced free of charge according to this procedure and warranty policy. In any case, however, shipping charges and customs clearance fees to be borne by the sender. To prove the date of your purchase when required, please keep the receipt or bills covering the purchase of your equipment for at least a year. Before sending your equipment for servicing, please make sure that you are sending it to the manufacturer's authorized representatives or their approved repair shops, unless you are sending it directly to the manufacturer. Always obtain a quotation for the service charge, and only after you accept the quoted service charge, instruct the service station to proceed with the servicing.

- This warranty policy does not affect the customer's statutory rights.
- The local warranty policies available from PENTAX distributors in some countries can supersede this warranty policy. Therefore, we recommend that you review the warranty card supplied with your product at the time of purchase, or contact the PENTAX distributor in your country for more information and to receive a copy of the warranty policy.



The CE Mark is a Directive conformity mark of the European Community.

For customers in USA

STATEMENT OF FCC COMPLIANCE

This device complies with Part 15 of the FCC Rules. Operation is subject to the following two conditions: (1) This device may not cause harmful interference, and (2) this device must accept any interference received, including interference that may cause undesired operation.

Changes or modifications not approved by the party responsible for compliance could void the user's authority to operate the equipment.

This equipment has been tested and found to comply with the limits for a Class B digital device, pursuant to part 15 of the FCC Rules.

These limits are designed to provide reasonable protection against harmful interference in a residential installation. This equipment generates, uses and can radiate frequency energy and, if not installed and used in accordance with the instructions, may cause harmful interference to radio communications. However, there is no guarantee that interference will not occur in a particular installation.

If this equipment does cause harmful interference to radio or television reception, which can be determined by turning the equipment off and on, the user is encouraged to try to correct the interference by one or more of the following measures:

- Reorient or relocate the receiving antenna.
 - Increase the separation between the equipment and receiver.
 - Connect the equipment into an outlet on a circuit different from that to which the receiver is connected.
- * Consult the dealer or an experienced radio/TV technician for help.

For customers in Canada

This Class B digital apparatus meets all requirements of the Canadian Interference - Causing Equipment Regulations.

Pour les utilisateurs au Canada

Cet appareil numérique de la classe B respecte toutes les exigences du Règlement sur le matériel brouilleur du Canada.

Declaration of Conformity
According to 47CFR, Parts 2 and 15 for
Class B Personal Computers and Peripherals

We: PENTAX Imaging Company
A Division of PENTAX of America, Inc.

Located at: 600 12th Street, Suite 300
Golden, Colorado 80401 U.S.A.
Phone: 303-799-8000 FAX: 303-790-1131

Declare under sole responsibility that the product identified herein complies with 47CFR Parts 2 and 15 of the FCC rules as a Class B digital device. Each product marketed is identical to the representative unit tested and found to be compliant with the standards. Records maintained continue to reflect the equipment being produced can be expected to be within the variation accepted, due to quantity production and testing on the statistical basis as required by 47CFR §2.909. Operation is subject to the following two conditions: (1) This device may not cause harmful interference, and (2) This device must accept any interference received, including interference that may cause undesired operation. The above named party is responsible for ensuring that the equipment complies with the standards of 47CFR §15.101 to §15.109.

Product Name: PENTAX Digital Still Camera

Model Number: Optio MX4

Contact person: Customer Service Manager

Date and Place: August, 2004, Colorado

PENTAX Corporation	2-36-9, Maeno-cho, Itabashi-ku, Tokyo 174-8639, JAPAN (http://www.pentax.co.jp/)
PENTAX Europe GmbH (European Headquarters)	Julius-Vosseler-Strasse, 104, 22527 Hamburg, GERMANY (HQ - http://www.pentaxeuropa.com) (Germany - http://www.pentax.de)
PENTAX U.K. Limited	PENTAX House, Heron Drive, Langley, Slough, Berks SL3 8PN, U.K. (http://www.pentax.co.uk)
PENTAX France S.A.S.	12/14, rue Jean Poulmarch, 95106 Argenteuil Cedex, FRANCE
PENTAX Benelux B.V.	(for Netherlands) Spinveld 25, 4815 HR Breda, NETHERLANDS (http://www.pentax.nl) (for Belgium & Luxembourg) Weiveldlaan 3-5, 1930 Zaventem, BELGIUM (http://www.pentax.be)
PENTAX (Schweiz) AG	Widenholzstrasse 1 Postfach 367 8305 Dietlikon, SWITZERLAND (http://www.pentax.ch)
PENTAX Scandinavia AB	P.O. Box 650, 75127 Uppsala, SWEDEN (http://www.pentax.se)
PENTAX Imaging Company A Division of PENTAX of America, Inc.	(Headquarters) 600 12th Street, Suite 300 Golden, Colorado 80401, U.S.A. (Distribution & Service Center) 16163 West 45th Drive, Unit H Golden, Colorado 80403, U.S.A. (http://www.pentaximaging.com)
PENTAX Canada Inc.	1770 Argentia Road Mississauga, Ontario L5N 3S7, CANADA (http://www.pentaxcanada.ca)



for your
precious moments

<http://www.digital.pentax.co.jp>

- Specifications and external dimensions are subject to change without notice.