

PENTAX™

Digital Camera

Optio 30

Operating Manual

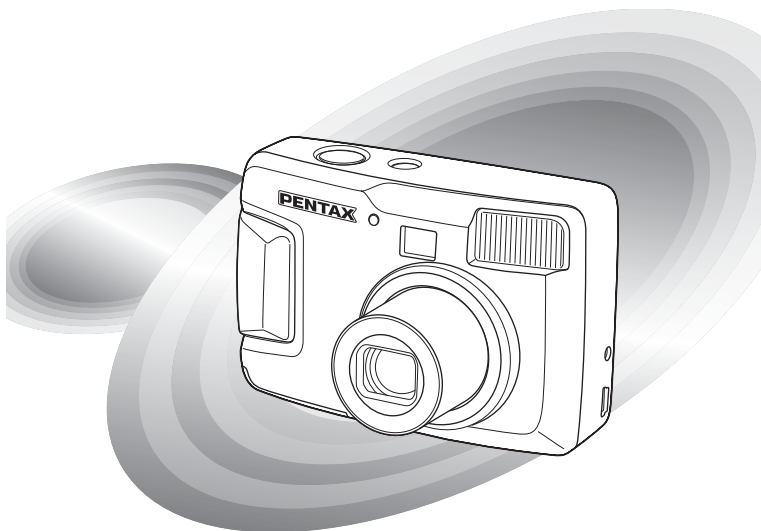

To ensure the best performance from your camera, please read the Operating Manual before using the camera.

Thank you for purchasing the PENTAX Optio 30 Digital Camera. Please read this manual before using the camera in order to get the most out of all the features and functions. Keep this manual safe, as it can be a valuable tool in helping you to understand all the camera's capabilities.

Regarding copyrights

Images taken using the Optio 30 that are for anything other than personal enjoyment cannot be used without permission according to the rights as specified in the Copyright Act. Please take care, as there are even cases where limitations are placed on taking pictures even for personal enjoyment during demonstrations, industrial enterprise or as items for display. Images taken with the purpose of obtaining copyrights also cannot be used outside the scope of use of the copyright as laid out in the Copyright Act, and care should be taken here also.

Regarding trademarks

- The SD logo  is a trademark.
- PENTAX is a trademark of PENTAX Corporation.
- Optio is a trademark of PENTAX Corporation.
- All other brands or product names are trademarks or registered trademarks of their respective companies.
- This product supports PRINT Image Matching II.

When used in combination, PRINT Image Matching II enabled digital still cameras, printers and software help photographers to produce images more faithful to their intentions.

Copyright© 2001 Seiko Epson Corporation. All Rights Reserved.

PRINT Image Matching is a trademark of Seiko Epson Corporation.

- "PictBridge" allows the user to connect the printer and digital camera directly, using the unified standard for the direct printout of images. You can print images directly from the camera through a few simple operations.

To users of this camera

- There is a possibility that recorded data may be deleted or that the camera may not function correctly when used in surroundings such as installations generating strong electromagnetic radiation or magnetic fields.
- The liquid crystal panel used in the LCD display is manufactured using extremely high precision technology. Although the level of functioning pixels is 99.99% or better, you should be aware that 0.01% or fewer of the pixels may not illuminate or may illuminate when they should not. However, this has no effect on the recorded image.
- There is a possibility that the illustrations and the display screen of the LCD monitor in this manual are different from the actual product.

FOR SAFE USE OF YOUR CAMERA

Sufficient attention has been paid to the safety of this product but please pay particular attention to the warnings indicated by the following symbols during use.



Warning

These symbols indicate that it is possible that the user may experience serious difficulties if the warnings are not heeded.



Caution

These symbols indicate that it is possible that the user may experience minor or middling difficulties or physical difficulties if the warnings are not heeded.



Warning

- Do not attempt to take the camera apart or remodel the camera. High voltages are present within the camera, and there is therefore a danger of electric shocks.
- If the inside of the camera should become exposed as a result of, for example, the camera being dropped, please do not under any circumstances touch such exposed portions, as there is a danger of receiving an electric shock.
- Wrapping the strap of the camera around your neck is also dangerous. Please take care that small children do not hang the strap around their necks.
- To avoid the risk of it being swallowed by mistake, keep the SD Memory Card out of the reach of small children. Seek medical attention immediately if accidentally swallowed.
- Use an AC adapter of the power and voltage specified for exclusive use with this product. The use of an AC adapter other than that specified exclusively for use with this product may cause fire or electric shocks.
- If the camera emits smoke or a strange smell, or in the event of any other irregularity, stop using the camera immediately, remove the battery or disconnect the AC adapter and contact your nearest PENTAX service center. Continued use of the camera may result in fire or electric shock.
- Discontinue use of the AC adapter during thunderstorms. This can cause a fire or electrical shock.

Caution

- Never try to disassemble or short the battery. Also, do not dispose of the battery in fire, as it may explode.
- Do not charge any batteries other than rechargeable Ni-MH batteries. The battery could explode or catch fire. Of the batteries that can be used in this camera, only the Ni-MH battery can be recharged.
- If any of the battery leakage should come in contact with your eyes, do not rub them. Flush your eyes with clean water and get medical attention immediately.
- If any of the battery leakage should come in contact with skin or clothes, wash the affected areas thoroughly with water.
- Remove the battery from the camera immediately if it becomes hot or begins to smoke. Be careful not to burn yourself during removal.
- Some portions of the camera heat up during use, so please take care, as there is a risk of low temperature burns if such portions are held for long periods of time.
- Do not place your finger on the flash when it is discharging as there is a risk of burns.
- Do not discharge the flash while it is touching your clothing as there is a risk of discoloring.
- Should the LCD be damaged, be careful of glass fragments. Also, be careful not to allow the liquid crystal to get on your skin or eyes or in your mouth.

Care to be Taken During Handling

- Take the international warranty card with you when you travel abroad. Also take the Worldwide Service Network that is included in the package. This will be useful if you experience problems abroad.
- When the camera has not been used for a long time, confirm that it is still working properly, particularly prior to taking important pictures (such as at a wedding or during travelling). PENTAX is not responsible for consequential damages (costs incurred as a result of taking pictures, loss of benefits that were to be obtained through taking pictures) arising from failure of this product.
- The lens on this camera is not exchangeable. The lens is not removable.
- Do not clean the product with organic solvents such as thinner or alcohol benzene.

- Places of high temperature and humidity should be avoided. Particular care should be taken regarding vehicles, which can become very hot inside.
- Storing the camera where pesticides and chemicals are handled should be avoided. Remove from case and store in a well-ventilated place to prevent the camera from becoming moldy during storage.
- Do not use the camera where it may come in contact with rain, water or any other liquid, because the camera is not weather, water, or liquid resistant. Should the camera get wet from rain, splashing water, or any other liquid, wipe it off immediately with a dry soft cloth.
- Ensure that the camera is not subjected to substantial vibrations, shocks or pressure. Place the camera on a cushion for protection when the camera is subjected to the vibrations of a motorbike, car, or ship, etc.
- The temperature range in which the camera can be used is 0°C to 40°C (32°F to 104°F).
- The liquid crystal display will become black at temperatures of approximately 60°C (140°F) but will return to normal when normal temperatures are returned to.
- The response speed of the liquid crystal display becomes slow at low temperatures. This is due to the properties of the liquid crystal and is not a fault.
- Periodic checks are recommended every 1 to 2 years in order to maintain high-performance.
- If the camera is subjected to rapid temperature changes, condensation may form on the inside and outside of the camera. Therefore put the camera in a bag or plastic bag, and take the camera out when the difference in temperature has subsided.
- Avoid contact with garbage, dirt, sand, dust, water, toxic gases, salt, etc. as this may cause damage to the camera. If rain or drops of water get onto the camera, please wipe dry.
- Refer to “Precautions when using an SD Memory Card” (p.16) regarding the SD Memory Card.
- Please do not press forcefully on the LCD monitor. This could cause breakage or malfunction.
- Be careful not to sit down with the camera in your back pocket as this may damage the exterior of the camera or the LCD monitor.
- When using a tripod with the camera, be careful not to overtighten the screw in the tripod socket on the camera.

CONTENTS

FOR SAFE USE OF YOUR CAMERA	1
Care to be Taken During Handling	2
CONTENTS	4
Contents of the Operating Manual	7
Checking Package Contents	8
Names of Parts	9
Names of Operating Parts	10
Getting Started	11
Attaching the Strap	11
Powering the Camera	12
Installing the Batteries	12
Using the AC Adapter (optional)	14
Installing / Removing the SD Memory Card	15
Turning the Camera On and Off	17
Playback Only Mode	17
Initial Settings	18
Setting the Display Language	18
Setting the Date and Time	19
Setting the Recorded Pixels and the Quality Levels	20
Quick Start	22
Taking Still Pictures	22
Playing Back Still Pictures	24
Playing Back Images	24
Playing Back Previous or Next Images	24
Common Operations	26
Using the Button Functions	26
Capture Mode	26
Playback Mode	27
Setting the Menus	28
How to Display the Menus	28
Basic Operation of the SIMPLE Menu	29
SIMPLE Menu List	29
Basic Operation of the FULL Menu	31
FULL Menu List	33
Taking Pictures	35
Setting the Shooting Functions	35
Changing the Mode	35
Displaying Shooting Information in Capture Mode	37
Selecting the Focus Mode	38
Selecting the Flash Mode	40

Selecting the Recorded Pixels.....	41
Selecting the Quality Levels	42
Adjusting the Color Balance according to Lighting (White Balance)	44
Changing the AF Area (Focusing Area)	45
Setting the Light Metering Range to Determine the Exposure (AE Metering)	46
Setting the Sensitivity	47
Setting the Image Sharpness	48
Setting the Color Saturation	49
Setting the Image Contrast	50
Taking Pictures	51
Setting the Functions (Program Mode).....	51
Selecting the Picture Mode according to the Shooting Scene (Picture Mode)	52
Taking Panorama Pictures (Panorama Assist Mode).....	55
Using the Self-Timer	57
Continuous Shooting (Continuous Shooting / Multi Continuous Shooting).....	58
Using the Zoom	59
EV Compensation.....	61
Taking Movie Pictures (Movie Picture Mode)	62
Changing the Recorded Pixels Setting When Taking Movie Pictures.....	64
Changing the Color Mode Setting When Taking Movie Pictures...66	
Taking Time-lapse Movie Pictures (Fast Fwd Movie).....	68
Saving the Settings (Memory)	70
Saving the Menu Items (Memory)	70
Playback / Deleting	72
Playing Back Images	72
Playing Back Still Pictures	72
Zoom Display.....	72
Displaying Shooting Information in Playback Mode	73
Nine Image Display	74
Playing Back Movie Pictures	75
Copying Files	76
Deleting Images	78
Deleting a Single Image	78
Deleting All Images.....	79
Protecting Images from Deletion (Protect)	80
Setting the Printing Service (DPOF).....	81
Printing Single Image	81
Printing All Images.....	83
Printing Directly from the Camera Connected to a Printer (PictBridge).....	84
Connecting the Camera to the Printer	84
Printing Single Image	85

Printing All Images.....	86
Printing Using the Printing Service Settings (DPOF).....	86
Disconnecting the Camera from the Printer	87
Editing / Settings	88
<hr/>	
Editing Images	88
Changing the Image Size	88
Trimming Images.....	90
Editing Images with Digital Filters.....	92
Camera Settings	94
Formatting an SD Memory Card or the Built-in Memory	94
Changing the Date Style and Date / Time	95
Changing the Display Language	95
Changing the Start-up Screen / Background Color	96
Sleep Timeout	98
Setting Auto Power Off.....	98
Changing the USB Connection Mode.....	99
Resetting to Default Settings [Reset].....	99
Appendix	100
<hr/>	
Messages	100
Troubleshooting	102
Main Specifications	104
Optional Accessories	106
WARRANTY POLICY	108

Checking Package Contents

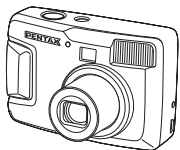

Camera
Optio 30

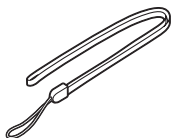

Strap
O-ST18 (*)

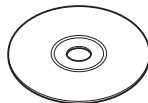

Software
(CD-ROM) S-SW18

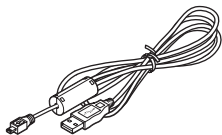

USB cable
I-USB6 (*)

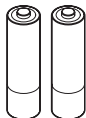

AA Alkaline batteries (2)

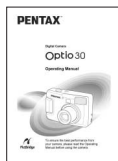

Operating Manual
(this manual)

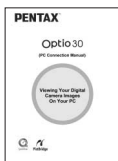

Operating Manual
(PC Connection Manual)

About items marked with (*)

* Items marked with (*) are also available as optional accessories. For other optional accessories, refer to the list on page 106.

*Type of AC plug cord

D-CO2A Australia / D-CO2B United Kingdom / D-CO2E Europe /
D-CO2H Hong Kong / D-CO2J Japan / D-CO2K Korea /
D-CO2U North America, Canada

Names of Parts

Front

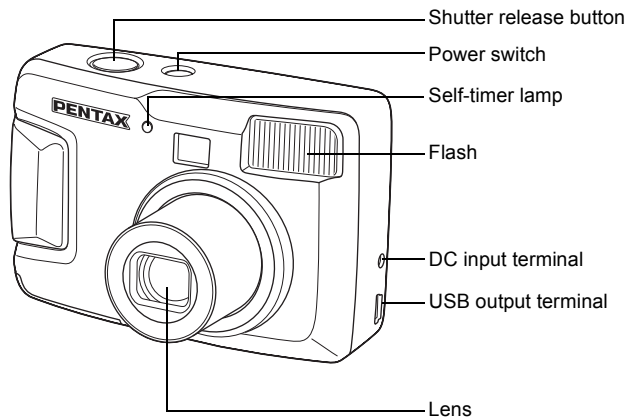

Back

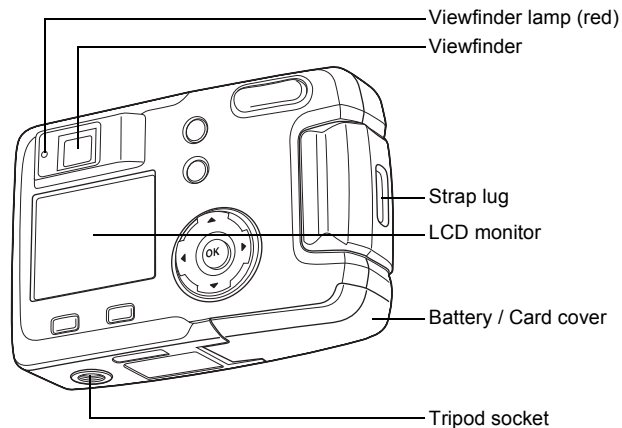

Names of Operating Parts

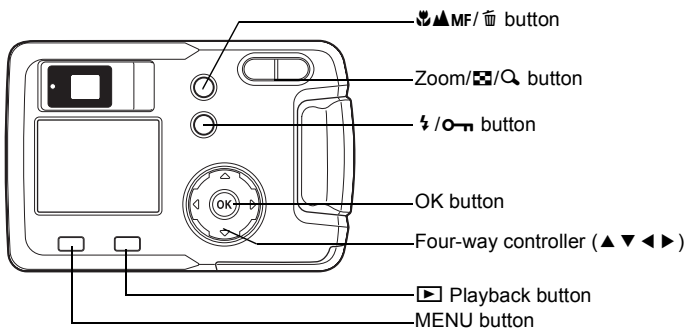

Guide indications

A guide to available button operation is displayed on the LCD monitor during operation. The buttons are indicated as shown below.

Four-way controller (▲)	▲	Zoom/ /Q button	
Four-way controller (▼)	▼	for digital zoom	Q
Four-way controller (◀)	◀	for trimming	Q
Four-way controller (▶)	▶	button	
MENU button	(MENU)	button	
▶ Playback button	▶	OK button	OK

Attaching the Strap

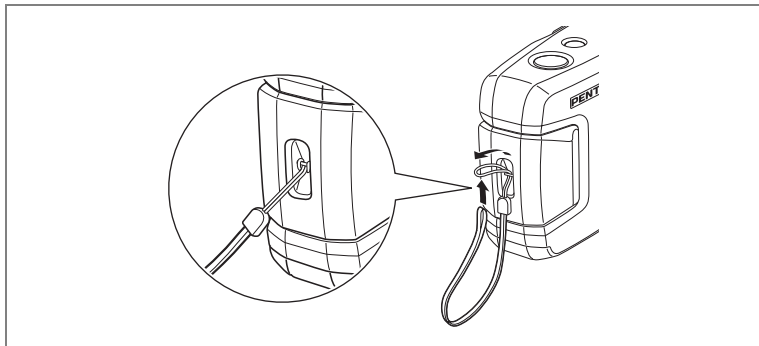

Pass the narrow end of the strap through the strap lug and pass the other end through the loop.

Powering the Camera

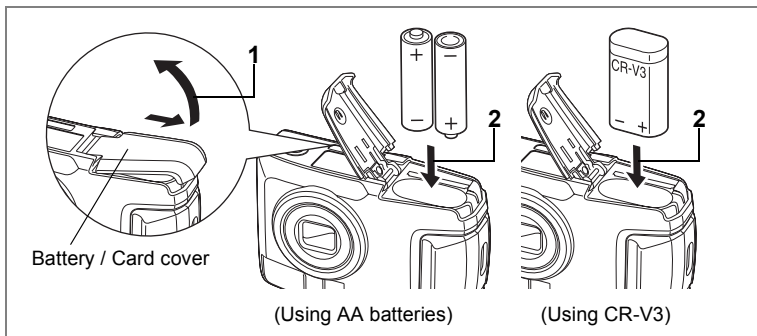

Installing the Batteries

Install batteries in the camera. Use one CR-V3, or use two AA lithium batteries, AA Ni-MH batteries, or AA alkaline batteries.

- 1 Slide the battery / card cover in the direction indicated by the arrow and flip the cover open.**
- 2 Insert the batteries according to the \oplus \ominus indicator in the battery chamber.**
- 3 Close the battery / card cover and push horizontally to lock.**



When using for a prolonged period, please use the AC adapter D-AC5 (optional) (p.14).



- CR-V3 battery, AA alkaline and AA lithium batteries are not rechargeable.
- Do not open the battery / card cover or remove the batteries when the power switch is on.
- If you do not intend to use the camera for a long time, remove the batteries. Otherwise, the batteries may leak.
- If the date and time settings have been reset when you insert new batteries after a long time, follow the procedure for “Setting the Date and Time” (p.19).
- Insert batteries correctly. Batteries inserted backwards may cause malfunction.

Number of Captures and Playback Time (At 25°C, with new batteries)

● Captures (Using flash 50% of the time)

	Image storage capacity
CR-V3	Approx. 600
Ni-MH batteries	Approx. 420
AA alkaline batteries	Approx. 140

● Playback

	Playback time
CR-V3	Approx. 520 min.
Ni-MH batteries	Approx. 340 min.
AA alkaline batteries	Approx. 240 min.

- These figures are based on PENTAX measuring conditions. Results may vary depending on the capture mode and shooting conditions.



- Generally, battery performance temporarily deteriorates as the temperature decreases. When the camera is used in a cold environment, keep this product warm by holding it in some protection against cold or inside the clothes. Battery performance once deteriorated due to low temperature will be recovered when the batteries are returned to room temperature.
- Due to the characteristics of AA alkaline batteries, camera performance may deteriorate at low temperatures. Use of other batteries (such as CR-V3) is recommended when using the camera at low temperatures.
- Be sure to take a spare battery with you when travelling abroad or to a cold region or if you intend to take a lot of pictures.
- You can maximize battery life by turning off the LCD monitor, and using the viewfinder to take pictures.

Battery Level Indicator

You can check the battery level by the  symbol displayed on the LCD monitor.

 (lit green) : Adequate power remains.



 (lit green) : Battery is running low.



 (lit yellow) : Battery is running very low.



 (lit red) : Battery is exhausted.



[Battery Depleted] : After the message is displayed, the camera will turn off.

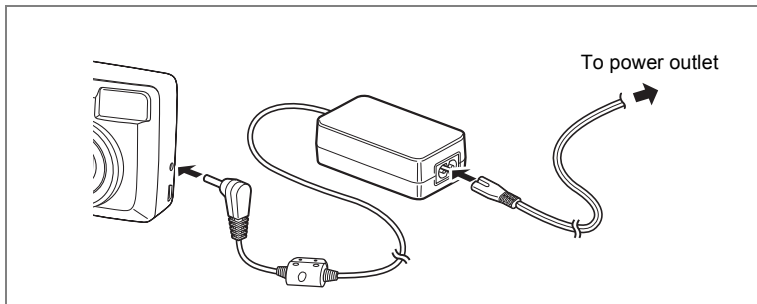

Using the AC Adapter (optional)

If you intend to use the LCD monitor for a long time or connect the camera to a PC, use of the AC adapter D-AC5 (optional) is recommended.

- 1 Connect the DC terminal on the AC adapter to the DC input terminal on the camera.**
- 2 Connect the AC plug cord to the AC adapter.**
- 3 Plug the AC plug cord into the power outlet.**



- Make sure that the camera is turned off when connecting or disconnecting the AC adapter.
- Make sure connections are secure between the camera, AC adapter, AC plug cord terminal and power outlet. If the cord becomes disconnected while the data is being recorded on the SD Memory Card, the data may be lost.
- When using the AC adapter, be sure to read the operating manual accompanying the AC adapter D-AC5.
- You cannot charge Ni-MH batteries in the camera by connecting the AC adapter. To charge Ni-MH batteries, use an Ni-MH battery charger.

Installing / Removing the SD Memory Card

1

Getting Started

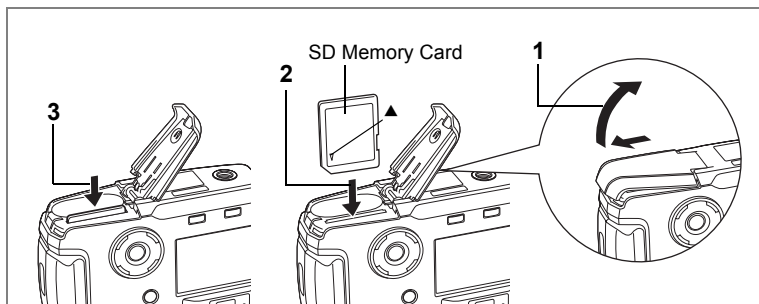

This camera uses an SD Memory Card. Captured images are recorded on the SD Memory Card if a card is inserted (☐ icon on the LCD monitor), or in the Built-in memory if no card is inserted (☑ icon on the LCD monitor). Make sure that the camera is turned off before inserting or removing the SD Memory Card.

- 1 Slide the battery / card cover in the direction indicated by the arrow and flip the cover open.**
- 2 Insert the SD Memory Card so the label (the side with the ▲ symbol) is facing toward the LCD monitor and push the card in until it clicks.**
- 3 Close the battery / card cover and push horizontally to lock.**

To remove the card, eject the card by pressing it in the direction indicated by the arrow and pull it out.

Data Backup

Very occasionally, data stored in the Built-in memory becomes unreadable. As a backup measure, we recommend that you download important data to a PC or store the data in a media other than the Built-in memory.

Precautions when using an SD Memory Card

- Make sure the camera is turned off before opening the battery / card cover.
- The SD Memory Card has a write-protect switch. Moving the switch to the [Lock] position prevents the recording and deleting of data and the formatting of the card and protects all saved data.
- When you purchase the SD Memory Cards, access the PENTAX website and confirm beforehand if they have compatibility with your camera. Inquiries on the card compatibility can also be answered by your nearest PENTAX service center.
- SD Memory Cards formatted on a PC or device other than the camera cannot be used. Be sure to format the card with the camera.
- The SD Memory Card may be hot when removed immediately after camera use. Be careful.
- Do not remove the card or turn off the camera when recording data or playing back images from the SD Memory Card, or when connected to a PC with the USB cable. This could cause data loss or card damage.
- Do not bend the SD Memory Card or subject it to violent impact. Do not get it wet or leave it in a high temperature location.
- New cards or cards used in another camera must be formatted before use. For more information about formatting the card, see "Formatting an SD Memory Card or the Built-in Memory" (p.94).
- Do not remove the SD Memory Card while the card is being formatted. The card may be damaged and become unusable.
- Data stored on an SD Memory Card may be deleted under the following conditions. PENTAX does not accept any liability regarding deleted data.
 - (1) When the user mishandles the SD Memory Card
 - (2) When the SD Memory Card is placed in a location with static electricity or electrical interference
 - (3) When the card is not used for a long time
 - (4) When the card, the AC adapter, or battery is removed while recording or reading data on the SD Memory Card
- The SD Memory Card has a finite operating life. The stored data may become unreadable after long periods of disuse. Please periodically backup important data onto your PC.
- Avoid using or storing your card where static electricity or electrical interference can occur.
- Do not use or store your card where it may be exposed to sudden temperature changes, condensation, or direct sunlight.

Write-protect switch

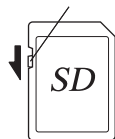

Turning the Camera On and Off

1

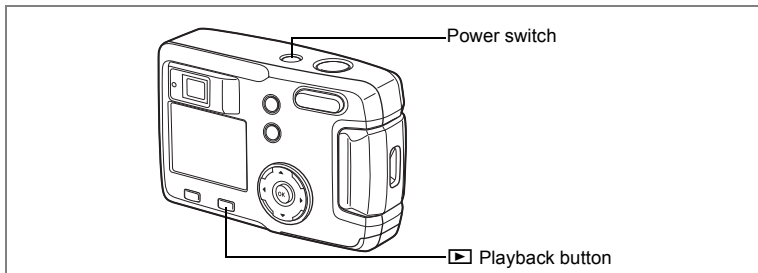

Getting Started



1 Press the power switch.

The camera will turn on. The lens cover opens and the lens extends. Press the power switch again to turn the camera off.

Card check feature

When the camera is turned on and the Built-in memory is being used,  appears on the LCD monitor. When the SD Memory Card is being used,  appears on the LCD monitor.

When the SD Memory Card write-protect switch is set to LOCK,  appears and images cannot be recorded.

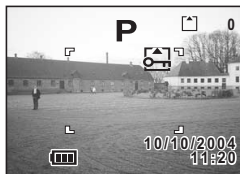

Playback Only Mode

Press the power switch while pressing the  Playback button to activate the Playback Only mode.

- When the camera is turned on in Playback Only mode, the lens does not extend.
- To switch from Playback Only mode to Capture mode, press the power switch twice to turn the camera off and then on again.

Playing Back Still Pictures  p.72

Initial Settings

1

Getting Started

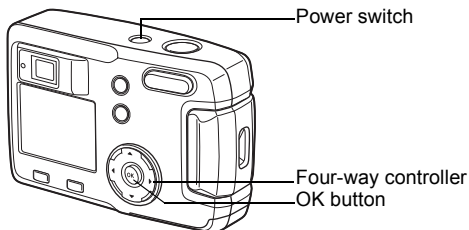

If the initial settings screen appears when you turn the camera on, follow the procedure below to set the display language and current date and time. If the date and time that appear at the bottom right of the LCD monitor are not the current date and time, follow the instructions for “Changing the Date Style and Date / Time” (p.95) to set the correct date and time.

The Initial Settings are not needed if the above screens do not appear.

Setting the Display Language

You can choose the language in which the menus, error messages, etc. are displayed from the following: English, French, German, Spanish, Italian, Russian, Chinese and Japanese.

- 1 Turn the camera on.**
- 2 Use the four-way controller (◀▶) to select the display language.**

The default setting is English.

- 3 Press the OK button.**



You can change the setting after it has been made. Refer to “Changing the Display Language” (p.95).

Setting the Date and Time

Set the current date and time, and the display style.

- 1 Use the four-way controller (▲ ▼) to select the date and time display style.**

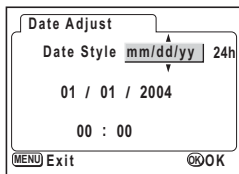

- 2 Press the four-way controller (▶).**
▲ and ▼ will be displayed above and below "24h".

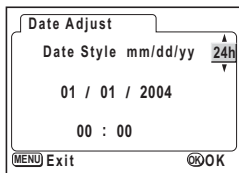

- 3 Use the four-way controller (▲ ▼) to select 24h (24-hour display) or 12h (12-hour display).**

- 4 Press the four-way controller (▶).**
▲ and ▼ will be displayed above and below the month.

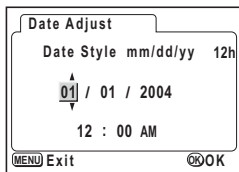

- 5 Use the four-way controller (▲ ▼) to change the month.**

- 6 Press the four-way controller (▶).**
▲ and ▼ will be displayed above and below the day.

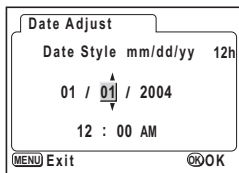

7 Use the four-way controller (▲▼) to change the day and press the four-way controller (▶) again.

▲ and ▼ will be displayed above and below the year.

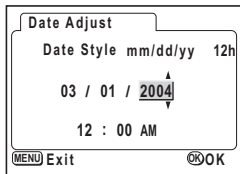

8 Repeat step 7 to change the [year], [hour], and [minutes].

9 Press the OK button.

The camera is ready to take a picture. When you set the date and time using the MENU button, you will return to the Menu screen. Press the OK button again.



- When you finish the settings and press the OK button to set the date and time, the camera clock is reset to 00 seconds.
- When the initial settings screen is displayed, you can cancel the settings operation and switch to Capture mode by pressing the MENU button. If this is done, the initial settings screen will be displayed next time you turn the camera on.
- You can change the settings after they have been made. Refer to “Changing the Date Style and Date / Time” (p.95).

Setting the Recorded Pixels and the Quality Levels

You can set the size and quality of the recorded pixels to correspond with the application of the image.

A much clearer image can be obtained and printed when both the recorded sizes and the pixel quality star levels are greater.

Use the [📷 Rec. Mode] menu for setting.

See “Basic Operation of the FULL Menu” (p.31) , “Selecting the Recorded Pixels” (p.41) and “Selecting the Quality Levels” (p.42) for the setting procedure.

● Selecting Recorded Pixels and Suitable Applications

2048×1536	Suitable for printing on A4 paper
1600×1200	Suitable for printing on A5 paper
1024×768	Suitable for printing on postcards
640×480	Suitable for attaching to e-mails or for creating websites

The default setting is [2048×1536].

● Selecting Quality Levels and Suitable Applications

★★★	Best	Lowest compression ratio. Suitable for photo prints.
★★	Better	Standard compression ratio. Suitable for viewing the image on a computer screen.
★	Good	Highest compression ratio. Suitable for attaching to e-mails or creating websites.

The default setting is [★★★].

● Approximate Number of Recordable Images, Recorded Pixels and Quality Levels

Quality Level Recorded Pixels	Best ★★★	Better ★★	Good ★	Movie pictures (320×240)	Movie pictures (160×120)
2048×1536	7	13	19	42 sec.	155 sec.
1600×1200	12	20	28		
1024×768	25	46	58		
640×480	54	84	103		

- The above table indicates the number of images when using the Built-in memory (16MB).
- The above table is based on standard shooting conditions specified by PENTAX and may vary depending on the subject, shooting conditions, capture mode, SD Memory Card, etc.

Settings in the SIMPLE Menu

This camera has two types of menus: SIMPLE menu, which can set commonly used functions, and FULL menu, which can set all functions. In the SIMPLE menu, the recorded pixels and quality level are set together with Image Quality.

Basic Operation of the SIMPLE Menu  p.29

Taking Still Pictures

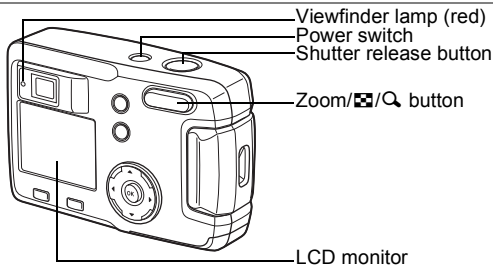

For the simplest procedure to take still pictures:
The flash fires automatically depending on the light conditions.

1 Press the power switch.

The camera will turn on.

2 Confirm the subject and shooting information on the LCD monitor.

The focus frame in the middle of the LCD monitor indicates the zone of automatic focusing. You can change the size of the subject by pressing the Zoom button.

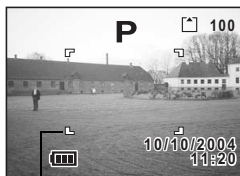

▲ : Makes the subject bigger

▲▲▲ : Makes the subject smaller

You can check the size of the subject by looking through the viewfinder.

3 Press the shutter release button halfway.

The focus frame on the LCD monitor will light green when the camera is in focus.

4 Press the shutter release button.

The image will be displayed on the LCD monitor for 1.5 seconds (Instant Review) and recorded on the SD Memory Card or in the Built-in memory. (The viewfinder lamp blinks slowly while the image is being recorded.)

Using the Shutter Release Button

The shutter release button works in a two-step action as follows.

• Press halfway

When the shutter release button is pressed lightly (halfway), the focus, exposure and white balance are locked. You can find the following information on the LCD monitor and the viewfinder lamp.

1. Autofocus frame

If the subject is in focus, the frame will light green. If the subject is out of focus, the frame will light red.

2. Viewfinder lamp

The viewfinder lamp (red) lights when the flash charge is completed.

The viewfinder lamp blinks when the flash is charging.

You cannot take a picture while the flash is charging or the camera is recording an image.

• Press down fully

The picture is taken.

[Poor focusing conditions]

The camera may not focus if the subject is in a condition shown below. Lock the focus on something that is the same distance away as the subject (press the shutter release button halfway), and press the shutter release button fully when you have composed your picture.

- Objects that lack contrast such as a blue sky or white walls
- Dark places or objects, and conditions that prevent light being reflected back
- Finely patterned objects
- Fast moving objects
- When an object in the foreground and one in the background are in the same picture
- Strongly reflected light or strong backlighting (bright background)

Instant Review

The Instant Review default setting is 1.5 seconds. During this time you can delete the image by pressing the  button (the [Delete] menu will be displayed), and selecting [Delete], and then pressing the OK button.

Playing Back Still Pictures

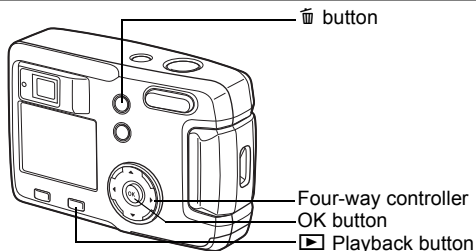

Playing Back Images

You can display the still picture.

- 1 Press the ▶ **Playback button** after taking a picture.

The image taken will be displayed on the LCD monitor.



Playing Back Previous or Next Images

Still pictures can be played back one at a time, proceeding either forward or backward.

- 1 Press the ▶ **Playback button** after taking a picture.
An image will be displayed on the LCD monitor.
- 2 Press the four-way controller (◀▶).





displays the previous image.





displays the next image.

Deleting a Displayed Image

During this time you can delete the image by pressing the  button (the Delete screen will be displayed), press the four-way controller () to select [Delete], and then pressing the OK button.

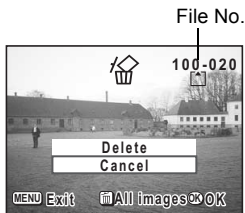
Press the shutter release button halfway or fully to return to capture mode.



- When the screen is changed to the playback screen, the image with the largest file number will be displayed first.
- You can enlarge the image displayed on the LCD monitor by pressing /Q on the Zoom//Q button.
- In the case of movie pictures, the first frame will be displayed.
- If there are no images stored, the [No image] message will be displayed.

Zoom Display  p.72

Using the Button Functions

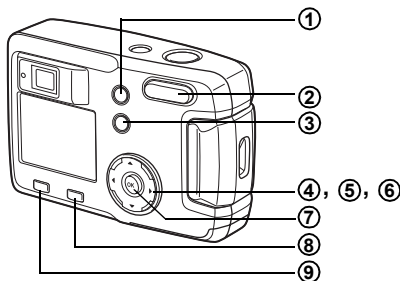

The buttons on your camera will function differently in different camera modes.

Capture Mode

- ① **MF button**
Changes the capture mode as follows.
Macro mode (☞p.38), Infinity-landscape mode (☞p.38),
Manual focus mode (☞p.38)
- ② **Zoom button**
Changes the size of the subject on the LCD monitor or viewfinder. (☞p.59)
- ③ **Flash button**
Changes the flash mode. (☞p.40)
- ④ **Four-way controller (◀▶)**
Changes the EV compensation. (☞p.61)
- ⑤ **Four-way controller (▲)**
Selects Self-timer mode or Continuous Shooting mode. (☞p.57, 58)
- ⑥ **Four-way controller (▼)**
Displays the virtual mode dial and changes the capture mode. (☞p.35)
- ⑦ **OK button**
Determines the menu item.
- ⑧ **Playback button**
Switches to Playback mode. (☞p.35)
- ⑨ **MENU button**
Displays SIMPLE menu or [📷 Rec.Mode] menu. (☞p.33)

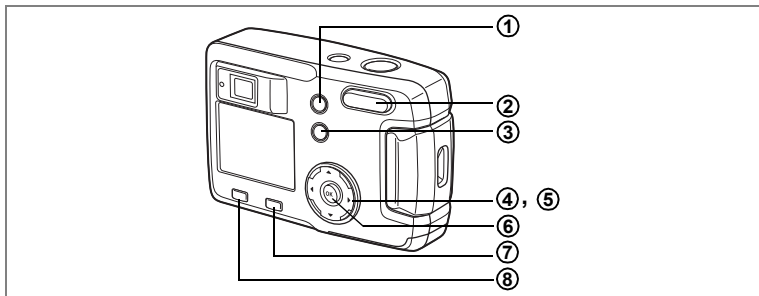

Playback Mode

- ① **🗑️ button**
Deletes the image. (☞p.78)
- ② **Zoom/📷/🔍 button**
Press 🔍 during normal playback to change the size of the Zoom Display image displayed on the LCD monitor. (☞p.72)
Press 📷 during normal playback to display nine images at once. (☞p.74)
- ③ **🔒 button**
Protects the image from deletion. (☞p.80)
- ④ **Four-way controller (◀▶)**
Plays back previous or next image. (☞p.24)
- ⑤ **Four-way controller (▲)**
Sets the DPOF settings. (☞p.81)
- ⑥ **OK button**
Saves the function selected by the menu item. (☞p.29, 31)
When pressed in [Zoom Display] or [Nine Image Display] mode, changes to normal playback mode. (☞p.72, 74)
- ⑦ **▶ Playback button**
Switches to Capture mode.
- ⑧ **MENU button**
Displays SIMPLE menu or [▶ Playback] menu. (☞p.29, 33)

Setting the Menus

When you press the MENU button, the menus are displayed on the LCD monitor. You can set functions, save the settings, and change the camera settings on these menus.

This camera has two types of menus: SIMPLE menu, which can set commonly used functions, and FULL menu, which can set all functions.

How to Display the Menus

1 Press the MENU button in Capture or Playback mode.

The SIMPLE menu screen is displayed by default.

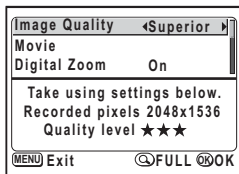

SIMPLE Menu

2 Press the Zoom/⏏/Q button.

The FULL menu screen is displayed. Press Zoom/⏏/Q again to display the SIMPLE menu screen.

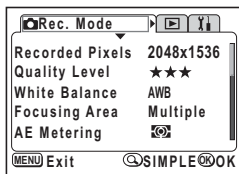

FULL Menu



The menu setting is saved even when the camera is turned off. If the camera is turned off with the FULL menu displayed, the FULL menu will be displayed the next time the camera is turned on.



When switching from the FULL menu to the SIMPLE menu, the settings not available in the SIMPLE menu will be reset to the initial settings.

Basic Operation of the SIMPLE Menu

The SIMPLE menu screen displays only commonly used menus. The same menu will be displayed in both Capture mode and Playback mode.

1 Use the four-way controller (▲▼) to select an item.

Use the four-way controller (▲▼) to move the frame up or down. A description of the item in the frame is displayed at the bottom of the screen.

2 Use the four-way controller (◀▶) to change the setting.

If there is a Select screen, use the four-way controller (▶) to move to the Select screen.

When you have finished making the settings, press the OK button to return to the menu.

3 Press the OK button.

The settings will be saved and the screen will return to capture or playback status.



- If you press any buttons, except the OK button, before pressing the OK button to leave the menu screen, any changes to the settings will not be saved.
- Even after you press the OK button and leave the menu screen, if you turn the camera off incorrectly (such as removing the battery when the camera is on), any changes to the settings will not be saved.

SIMPLE Menu List

Item	Description	Reference
Image Quality	For setting the recorded pixels and quality level of still pictures	p.43
Movie	For setting the recorded pixels of the movie picture, color mode and fps for Fast Fwd Movie	p.64 - 69
Digital Zoom	For setting the digital zoom	p.60
Digital Filter	For filtering the captured image	p.92
Format	For formatting the SD Memory Card or Built-in memory	p.94
Date Adjust	For adjusting the date and time	p.95
Language/言語	For changing the language in which menus and messages are displayed	p.95
Screen Setting	For setting the start-up screen and background screen	p.96
USB Connection	For changing the USB connection mode	p.99

Example of SIMPLE Menu Operation

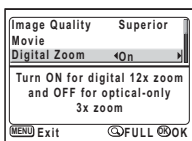
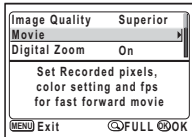
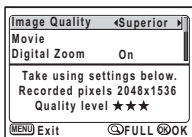

To the next screen

Select Screen

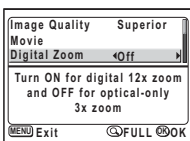
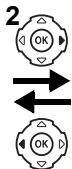
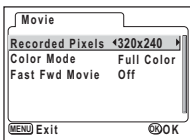
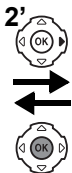

Basic Operation of the FULL Menu

The FULL menu screen displays all of the menus. The FULL menu screen displays the [📷 Rec.Mode], [▶ Playback] and [⚙️ Set-up] menus.

1 Use the four-way controller (◀▶) to select a menu.

When the frame is at the menu tab, use the four-way controller (◀▶) to change the menu.

2 Use the four-way controller (▲▼) to select an item.

Use the four-way controller (▲▼) to move the frame up or down.

3 Use the four-way controller (◀▶) to change the setting.

If there is a Select screen, use the four-way controller (▶) to move to the Select screen.

When you have finished making the settings, press the OK button to return to the menu.

4 Press the OK button.

The settings will be saved and the screen will return to capture or playback status.



- If you press any buttons, except the OK button, before pressing the OK button to leave the menu screen, any changes to the settings will not be saved.
- Even after you press the OK button and leave the menu screen, if you turn the camera off incorrectly (such as removing the battery when the camera is on), any changes to the settings will not be saved.

Example of FULL Menu Operation (When the MENU Button is Pressed in Capture Mode)

[Rec.Mode] Menu

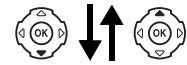
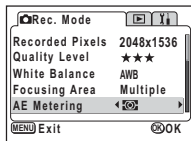
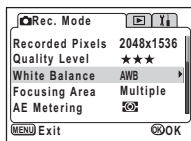
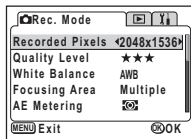
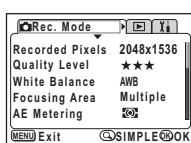

To the next screen

1 [Playback] Menu

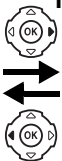

1 [Set-up] Menu

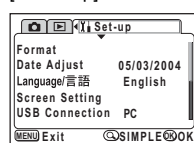

3' Select Screen

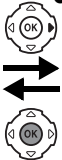

3

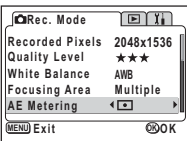
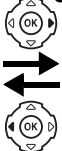

- If you press the shutter release button halfway, the camera switches to Capture mode and any changes to the settings will not be saved.
- When you display the menu from Capture mode, the [Rec.Mode] menu will be displayed, and when you display the menu from Playback mode, the [Playback] menu will be displayed.

[Set-up] Menu



Item	Description	Reference
Format	For formatting the SD Memory Card or the Built-in memory	p.94
Date Adjust	For changing the initial date and time settings	p.95
Language/言語	For changing the language in which menus and messages are displayed	p.95
Screen Setting	For setting the start-up screen and background screen	p.96
USB Connection	For changing the USB connection mode	p.99
Sleep Timeout	For setting the power saving function	p.98
Auto Power Off	For turning off the power automatically	p.98
Reset	For returning the camera settings to defaults	p.99

Setting the Shooting Functions

Changing the Mode











Capture mode is for taking pictures and Playback mode is for playing back or deleting images.

Switching Between Capture Mode and Playback Mode

- To change from Capture mode to Playback mode, press the  Playback button.
- To change from Playback mode to Capture mode, press the  Playback button or press the shutter release button halfway or fully.

Selecting the Capture Mode

Display the virtual mode dial to select Capture mode. There are 12 modes to choose from.

P	Program mode	The camera automatically sets the shutter speed and aperture for taking still pictures.	p.51
	Landscape mode	Lets you take landscape photos with bright colors.	p.52
	Night-Scene mode	Lets you take dark scenes such as night views.	
	Night-Scene Portrait	Lets you take portraits in dark conditions.	
	Portrait mode	Lets you take portraits with spatial effect, by emphasizing the person.	
	Surf & Snow mode	Lets you take clear photos at dazzling places like beaches and snow covered mountains.	
	Flower mode	Lets you take flower photos bright in color.	
	Party mode	Lets you take pictures of a party while capturing the background.	
	Food mode	Lets you take vivid pictures of prepared food that will whet your appetite.	
	Pet mode	Lets you take pictures of your pet that beautifully capture the color of your pet's coat.	
	Movie Picture mode	Lets you take movie pictures.	p.62
	Panorama Assist mode	Lets you take pictures to create panoramic images using the provided software.	p.55

1 Press the four-way controller (▼) in Capture mode.

The virtual mode dial appears.



2 Use the four-way controller (◀▶) to select a mode.

The icon will be surrounded by a square frame.

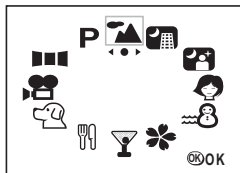

3 Press the OK button.

The icon of the selected Capture mode is displayed and the camera is ready to take pictures.

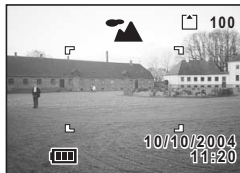

Displaying Shooting Information in Capture Mode

You can display information on the LCD monitor when shooting. Following display modes can be changed by pressing the OK button each time.

Normal Display

Shooting information is displayed when the power is turned on.

- | | |
|-------------------------------|--------------------------|
| 1 Flash mode | 2 Shooting mode |
| 3 Focus mode | 4 Capture mode |
| 5 AF frame | 6 Card / Built-in memory |
| 7 Number of recordable images | |
| 8 Battery indicator | 9 Date and time |

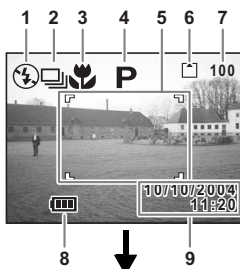

Histogram Display

The brightness distribution of the image is displayed.

The horizontal axis shows the brightness (darkest at the left end and brightest at the right end) and the vertical axis shows the number of pixels.

- | | |
|-----------------|------------|
| 1 Shutter speed | 2 F number |
| 3 Histogram | |

(No.1 and 2 appear when shutter release button is pressed halfway.)

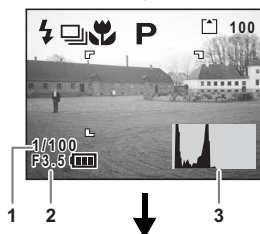

No Information Display

No shooting information is displayed.

- The AF frame is displayed in Autofocus mode.
- Settings are displayed for a few seconds when changed.

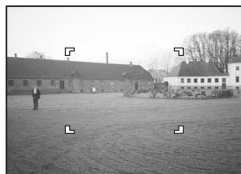



LCD Monitor Off

The LCD monitor is turned off.



Normal Display



The display cannot be turned off in  and  mode.

Saving the Display Mode  p.70

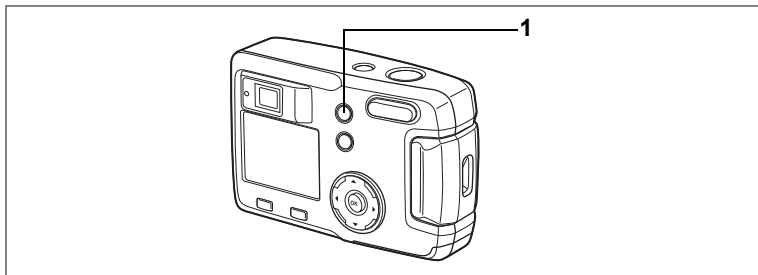

Selecting the Focus Mode

Focus Mode

(No icon)	Autofocus mode	The camera is focused on the subject in the autofocus area when the shutter release button is pressed halfway. Use this mode when the distance to the subject is more than 50 cm (20 inches).
📷	Macro mode	This mode is used when the distance to the subject is approx. 2 cm – 60 cm (0.8 inch – 24 inches). When the shutter release button is pressed halfway, the camera is focused on the object in the autofocus area.
▲	Infinity-landscape mode	This mode is used for taking distant objects.
MF	Manual focus mode	Adjust focus manually with the four-way controller (▲▼).

1 Press the 📷▲MF button in Capture mode.

The focus mode changes each time the button is pressed and the set mode is displayed on the LCD monitor.

The camera is ready to take a picture in the set focus mode.



- The default setting of the focus mode is [Autofocus mode].
- When the Movie Picture mode (p.62) is selected, only [Autofocus mode] is available.
- If you use the flash in [Macro mode], the image may be overexposed or vignetting may occur at the bottom right of the picture.
- The lens is fixed at the Wide position in Macro mode.



If you take a picture while looking through the viewfinder when the focus mode is set on [Macro mode], the range of the resulting picture will differ from what was seen in the viewfinder. Be sure to check the image on the LCD monitor.

Manual Focus

In MF mode, press the four-way controller (▲▼) to enlarge the central portion of the screen to full screen on the LCD monitor.
Use the four-way controller to adjust the focus while watching the image on the monitor. The current focus position is displayed on the left of the LCD monitor.



For distant focus



For closer focus

After the focus is set, press any buttons except the four-way controller (▲▼) or remove your finger from the four-way controller. The screen returns to the normal display about five seconds later.



When focusing, hold down the four-way controller (▲▼) to focus quickly.

Saving the Focus Mode  p.70

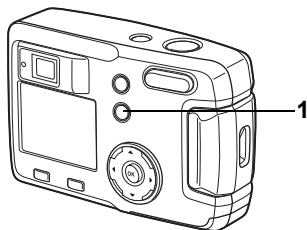

Selecting the Flash Mode

(No icon)	Auto flash	The flash discharges automatically depending on the light conditions.
	Flash Off	The flash will not discharge, regardless of the brightness.
	Flash On	The flash discharges regardless of the brightness.
	Auto flash + Red-eye reduction	This mode reduces the phenomenon of red eyes caused by the light from the flash being reflected in the subject's eyes. The flash discharges automatically.
	Flash On + Red-eye reduction	This mode reduces the phenomenon of red eyes caused by the light from the flash being reflected in the subject's eyes. The flash will discharge regardless of lighting conditions.



- The flash is off when the Capture mode is set to Movie Picture mode, Continuous Shooting or Multi Continuous Shooting, or when the focus mode is set to Infinity-Landscape.
- In Auto flash + Red-eye reduction or Flash On + Red-eye reduction, the flash discharges once before taking the picture to make the iris of the subject's eyes contract, shortly before firing again to take the picture.

1 Press the button in Capture mode.

The flash mode changes each time the button is pressed and the icon is displayed on the LCD monitor.

The camera is ready to take the picture in the set flash mode.

Saving the Flash Mode p.70

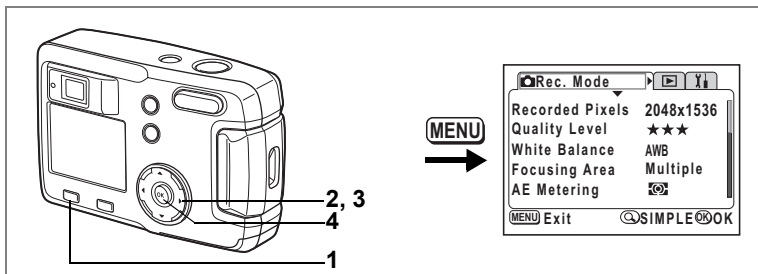

Selecting the Recorded Pixels

You can choose the number of recorded pixels from [2048×1536], [1600×1200], [1024×768] and [640×480].

The more pixels there are, the larger the image size and file size.

The image file size will also differ according to the quality level settings.

2048×1536	Suitable for printing on A4 paper
1600×1200	Suitable for printing on A5 paper
1024×768	Suitable for printing on postcards
640×480	Suitable for attaching to e-mails or for creating websites

1 Press the MENU button in Capture mode.

The [Rec. Mode] menu will be displayed.

Press the Zoom/[Z]/[Q] button if the SIMPLE menu is displayed. (p.28)

2 Use the four-way controller (▲▼) to select [Recorded Pixels].

3 Use the four-way controller (◀▶) to change the recorded pixels.

4 Press the OK button.

The camera is ready to take the picture.

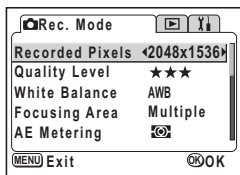

- In the Movie Picture mode, you can choose 320×240 pixels or 160×120 pixels. (p.64)
- If you select a large size, the picture may appear distinct when it is printed out.
- In the SIMPLE menu, the recorded pixels and quality level are set by the Image Quality. (p.43)

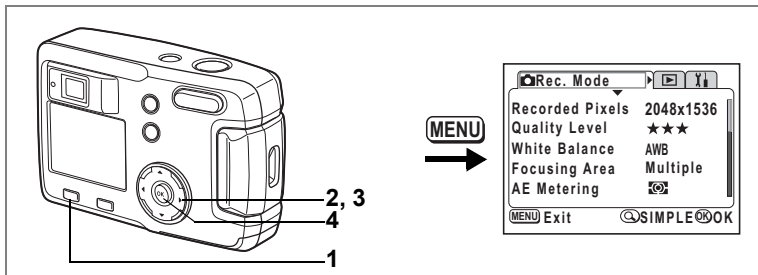

Selecting the Quality Levels

4

Taking Pictures

You can choose the image compression ratio.
The more stars, the clearer the quality and the larger the volume.
The recorded pixels setting also changes the picture volume.

★★★	Best	Lowest compression ratio. Suitable for photo prints.
★★	Better	Standard compression ratio. Suitable for viewing the image on a computer screen.
★	Good	Highest compression ratio. Suitable for attaching to e-mails or creating websites.

1 Press the MENU button in Capture mode.

The [Rec. Mode] menu will be displayed.

Press the Zoom/ button if the SIMPLE menu is displayed. (p.28)

2 Use the four-way controller (▲▼) to select [Quality Level].

3 Use the four-way controller (◀▶) to change the quality level.

4 Press the OK button.

The camera is ready to take the picture.

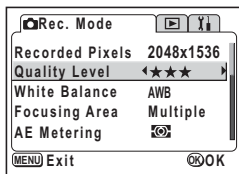

Settings in the SIMPLE Menu

In the SIMPLE menu, the recorded pixels and quality level are set by the Image Quality. You can choose from the following four qualities.

Image Quality	Recorded Pixels	Quality Level
Superior	2048×1536	★★★
Super	1600×1200	★★
Normal	1024×768	★★
Economy	640×480	★★

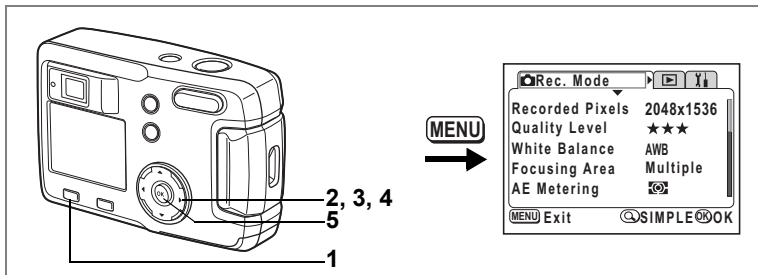

Adjusting the Color Balance according to Lighting (White Balance)

You can take pictures in natural colors by adjusting the white balance according to the light conditions at the time of shooting.

AWB	Auto	The camera adjusts the white balance automatically.
	Daylight	Use this mode when taking pictures outside in sunlight.
	Shade	Use this mode when taking pictures outside in the shade.
	Tungsten Light	Use this mode when taking pictures under electric or other tungsten light.
	Fluorescent Light	Use this mode when taking pictures under fluorescent light.

1 Press the MENU button in Capture mode.

The [Rec. Mode] menu will be displayed.

Press the Zoom//Q button if the SIMPLE menu is displayed. (p.28)

2 Use the four-way controller (▲▼) to select [White Balance].

3 Press the four-way controller (▶).

The White Balance screen will be displayed.

4 Use the four-way controller (▲▼) to change the setting.

5 Press the OK button twice.

The camera is ready to take the picture.

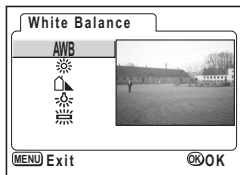

Saving the White Balance (p.70)

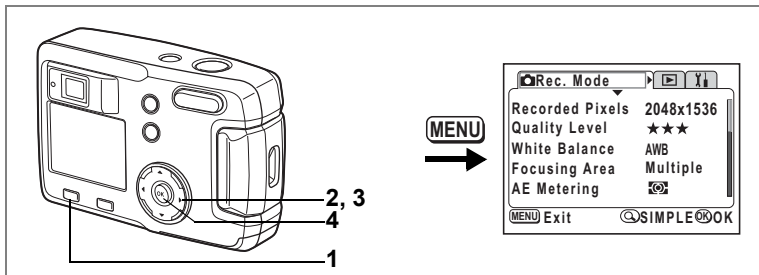

Changing the AF Area (Focusing Area)

You can change the autofocus area.

Multiple	Normal range
Spot	The autofocus range becomes smaller.

1 Press the MENU button in Capture mode.

The [Rec. Mode] menu will be displayed.

Press the Zoom/□/Q button if the SIMPLE menu is displayed. (p.28)

2 Use the four-way controller (▲▼) to select [Focusing Area].

3 Use the four-way controller (◀▶) to change the setting.

4 Press the OK button.

The camera is ready to take the picture.

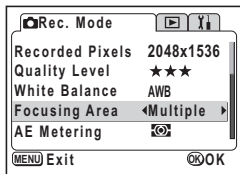

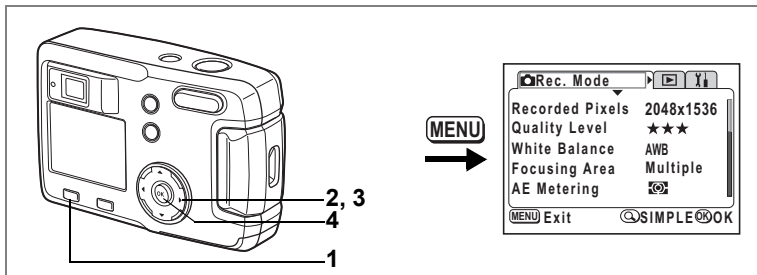

Setting the Light Metering Range to Determine the Exposure (AE Metering)

You can choose which part of the screen to use to measure the brightness and determine the exposure.

	Multi-segment	The exposure is determined by the entire screen.
	Center-weighted	The exposure is determined mainly by the center of the screen.
	Spot	The exposure is determined by the small area in the center of the screen only.

1 Press the MENU button in Capture mode.

The [📷 Rec. Mode] menu will be displayed.

Press the Zoom/📷/🔍 button if the SIMPLE menu is displayed. (📖p.28)

2 Use the four-way controller (▲▼) to select [AE Metering].

3 Use the four-way controller (◀▶) to change the metering mode.

4 Press the OK button.

The camera is ready to take the picture.

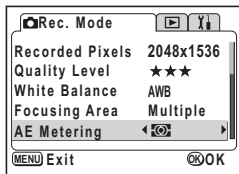

Saving the AE Metering 📖p.70

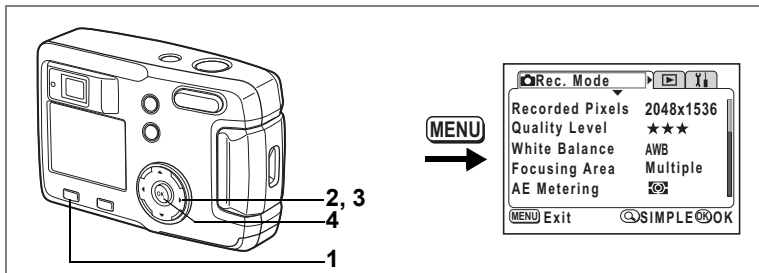

Setting the Sensitivity

You can select the sensitivity to suit the brightness of the surroundings.

Auto	The camera sets the sensitivity automatically.
50	<ul style="list-style-type: none"> The lower the sensitivity, the sharper the image and the less noise. The shutter speed will be slower in low light conditions. The higher the sensitivity, the faster the shutter speed in low light conditions to reduce camera shake, but the image may be affected by noise.
100	
200	
400	

1 Press the MENU button in Capture mode.

The [Rec. Mode] menu will be displayed.

Press the Zoom/Zoom In/Zoom Out button if the SIMPLE menu is displayed. (p.28)

2 Use the four-way controller (▲▼) to select [Sensitivity].

3 Use the four-way controller (◀▶) to select the sensitivity.

4 Press the OK button.

The camera is ready to take the picture.

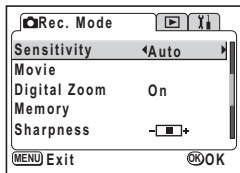

The only available AUTO settings are from 50 to 200.

Saving the Sensitivity p.70

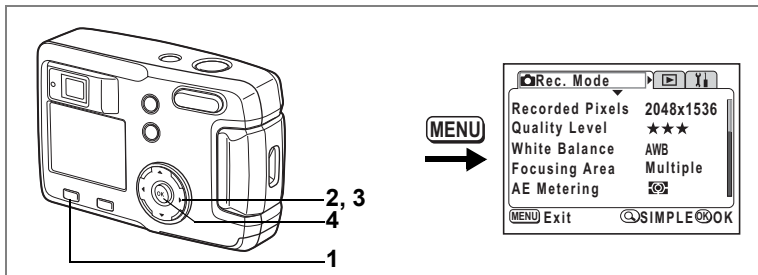

Setting the Image Sharpness

4

You can choose whether you want the image to have sharp or soft outlines.

1 Press the MENU button in Capture mode.

The [Rec. Mode] menu will be displayed.

Press the Zoom/ [] / [] button if the SIMPLE menu is displayed. (p.28)

2 Use the four-way controller (▲▼) to select [Sharpness].

3 Use the four-way controller (◀▶) to change the setting from [Normal] to [Hard] or [Soft].

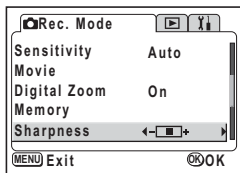

4 Press the OK button.

The camera is ready to take the picture.

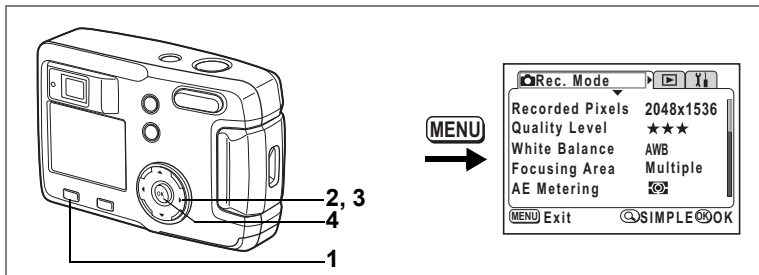

Setting the Color Saturation

You can set the color saturation.

1 Press the MENU button in Capture mode.

The [📷 Rec. Mode] menu will be displayed.

Press the Zoom/[📷]/[Q] button if the SIMPLE menu is displayed. (→p.28)

2 Use the four-way controller (▲▼) to select [Saturation].

3 Use the four-way controller (◀▶) to change the setting from [Normal] to [High] or [Low].

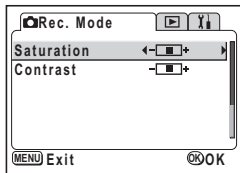

4 Press the OK button.

The camera is ready to take the picture.

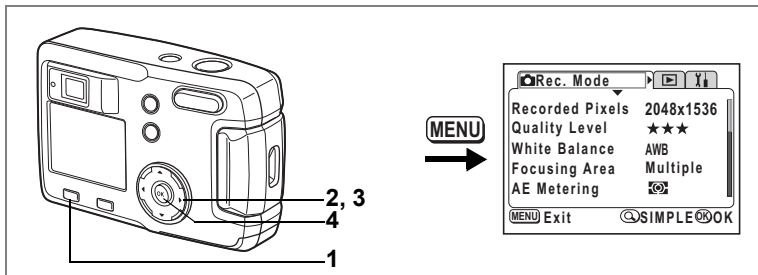

Setting the Image Contrast

4 You can set the image contrast.

1 Press the MENU button in Capture mode.

The [Rec. Mode] menu will be displayed.

Press the Zoom//Q button if the SIMPLE menu is displayed. (→p.28)

2 Use the four-way controller (▲▼) to select [Contrast].

3 Use the four-way controller (◀▶) to change the setting from (Normal) to (High) or (Low).

4 Press the OK button.

The camera is ready to take the picture.

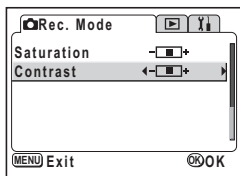

Taking Pictures

When an SD Memory Card has been inserted, all images are saved to the card. Images are saved to the Built-in memory when no card has been inserted.

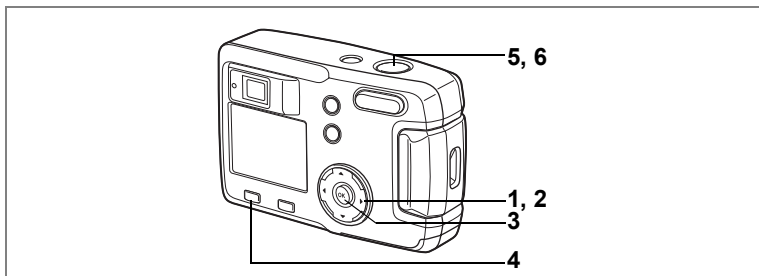

Setting the Functions (Program Mode)

In Program mode (**P**), the camera automatically sets the shutter speed and aperture for taking still pictures. However, you can change the function settings if necessary.

1 Press the four-way controller (▼) in Capture mode.

The virtual mode dial appears.

2 Use the four-way controller (◀▶) to select [P].

3 Press the OK button.

The camera is ready to take the picture.

4 Set the functions you want to use.

Refer to “Setting the Shooting Functions” (p.35 to p.50) for details of how to set the functions.

5 Press the shutter release button halfway.

The focus frame on the LCD monitor will light green when the camera is in focus.

6 Press the shutter release button.

The picture is taken.



Taking Still Pictures p.22

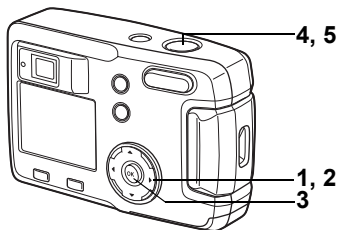

Selecting the Picture Mode according to the Shooting Scene (Picture Mode)

4

You can select the Picture mode according to the shooting scene.

Picture Mode

There are nine available modes in Picture mode.

	Landscape mode	Lets you take landscape photos with bright colors.
	Night-Scene mode	Lets you take dark scenes such as night views.
	Night-Scene Portrait mode	Lets you take portraits in dark conditions.
	Portrait mode	Lets you take portraits with spatial effect, by emphasizing the person.
	Surf & Snow mode	Lets you take clear photos at dazzling places like beaches and snow covered mountains.
	Flower mode	Lets you take flower photos bright in color.
	Party mode	Lets you take pictures of a party while capturing the background.
	Food mode	Lets you take vivid pictures of prepared food that will whet your appetite.
	Pet mode	Lets you take pictures of your pet that beautifully capture the color of your pet's coat.

1 Press the four-way controller (▼) in Capture mode.

The virtual mode dial appears.



2 Use the four-way controller (◀▶) to select the Picture mode.

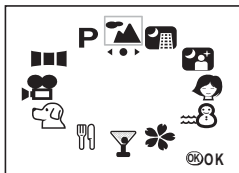

3 Press the OK button.

The Picture mode is selected.

The example shows the images when the  (Landscape mode) is selected.

4 Press the shutter release button halfway.

The focus frame on the LCD monitor will light green when the camera is in focus.

5 Press the shutter release button.

The picture is taken.

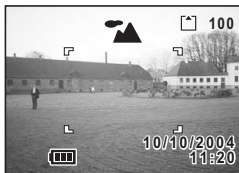

In Picture mode, the EV compensation, saturation, contrast, sharpness, and white balance are automatically set to the optimum values for each mode. You can change the settings.



To avoid camera movement in [Night-Scene] or [Night-Scene Portrait] mode, you are recommended to fix the camera on a tripod.

Taking Pictures in the Pet Mode

In the Pet mode, you can take pictures that enhance the color of your pet's coat.

Select the appropriate icon depending on whether your pet has a light-colored coat or a dark-colored coat.

1 Press the four-way controller (▼) in Capture mode.

The virtual mode dial appears.





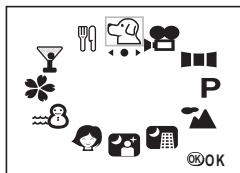

2 Use the four-way controller (◀▶) to select the Pet mode.



3 Use the four-way controller (▲▼) to select or .

There are two icons for the Pet mode, a dog and a cat.

Press the  button when the Pet mode is selected to switch between  and , and  and .

* It does not matter whether you choose the dog or the cat icon. The resulting picture is only affected by the choice of coat color.

4 Press the OK button.

The Pet mode is selected.

5 Press the shutter release button halfway.

The focus frame on the LCD monitor will light green when the camera is in focus.

6 Press the shutter release button.

The picture is taken in the selected Pet mode.

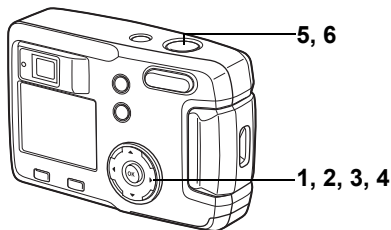

Taking Panorama Pictures (Panorama Assist Mode)

Using the provided software (ACDSee for PENTAX), you can join multiple images and easily create panoramic photos. Use Panorama Assist mode to combine images taken so that edges overlap to create a single panoramic photo.

- 1 Press the four-way controller (▼) in Capture mode.**

The virtual mode dial appears.



- 2 Use the four-way controller (◀▶) to select [P] Panorama Assist.**

- 3 Press the OK button.**



- 4 Use the four-way controller to choose the direction in which the images will be joined.**

- ◀ Joins the images at the left.
- ▶ Joins the images at the right.
- ▲ Joins the images at the top.
- ▼ Joins the images at the bottom.

The example shows the images when ▶ is selected.

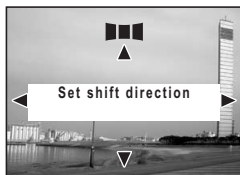

5 Take the first picture.

Press the shutter release button to take the first image. The right edge of the image is displayed in half-transparent form on the left of the LCD monitor.



6 Move the camera to the right and take the second picture.

Position the camera so that the fixed image display overlaps the left edge of the half-transparent display and then release the shutter. Repeat step 5 and 6 for taking the third and following pictures.



To change the direction in which the images will be joined, return to step 1 and choose again.



To cancel Panorama mode, change to another mode.



- You cannot use the camera itself to create panoramic images. Use the provided software (ACDSee for PENTAX) to join the pictures. For details on creating panorama images, see the separate booklet "PC Connection Manual".
- Continuous shooting and multi continuous shooting are not possible in Panorama Assist mode.

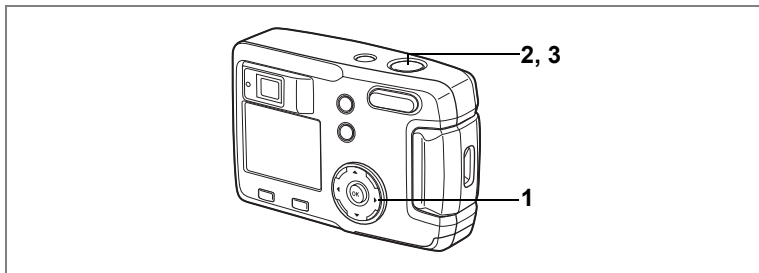

Using the Self-Timer



The picture will be taken ten seconds or two seconds after the shutter release button is pressed.

1 Press the four-way controller (▲) in Capture mode to display  or  on the LCD monitor.

2 Press the shutter release button halfway.

The focus frame on the LCD monitor will light green when the camera is in focus.

3 Press the shutter release button.

-  The self-timer is engaged and the self-timer lamp lights for about seven seconds. The picture is taken about three seconds after the self-timer lamp starts to blink.
-  The self-timer is engaged and the picture is taken about two seconds after the self-timer lamp starts to blink.



- The number of seconds until the picture is taken will be displayed on the LCD monitor.
- To cancel the self-timer, press the four-way controller or the MENU button while the second count is displayed.

Playing Back Still Pictures  p.24

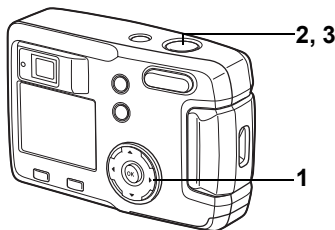

Continuous Shooting (Continuous Shooting / Multi Continuous Shooting)

Pictures are taken continuously while the shutter release button is pressed. There are two available modes: Continuous Shooting and Multi Continuous Shooting.

	Continuous Shooting	Images are captured, processed and saved one by one.
	Multi Continuous Shooting	Pictures are taken four frames at a time and saved as a single image.

1 Press the four-way controller (▲) to display or on the LCD monitor.

2 Press the shutter release button halfway.

The focus frame on the LCD monitor will light green when the camera is in focus.

3 Press the shutter release button.

- Pictures will be taken continuously while the shutter release button is pressed. Shooting stops when you remove your finger from the shutter release button.
- Pictures are taken four frames at a time and saved as a single image.

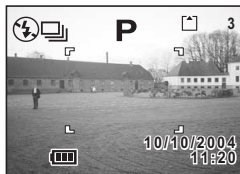

Playing Back Still Pictures p.24



- You can continue shooting until the SD Memory Card is full.
- The interval will vary according to the [Recorded Pixels] and [Quality Level] setting.
- The recorded pixels are fixed at 1280 × 960 in Multi Continuous Shooting mode.



- The flash will not discharge in Continuous Shooting or Multi Continuous Shooting mode.
- Continuous Shooting and Multi Continuous Shooting are not available for Movie Picture, Panorama Assist, Night-Scene or Night-Scene Portrait mode.

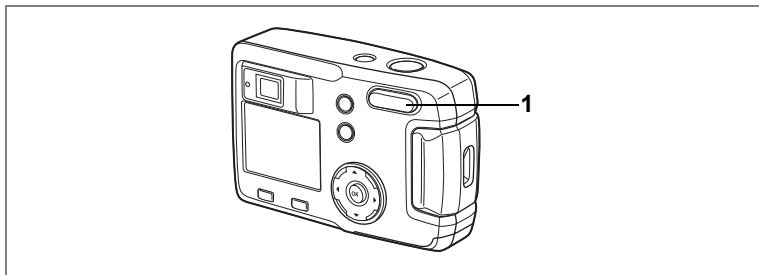

Using the Zoom

You can use the zoom to take pictures in Tele or Wide mode.

1 Press the Zoom button in Capture mode.

- ▲ : Makes the subject bigger
- ▼▼▼ : Makes the subject smaller

When the digital zoom function is disabled, you can take pictures at up to three times magnification using the optical zoom.

When the digital zoom is enabled, you can further enlarge the subject to a maximum magnification equivalent to four times.

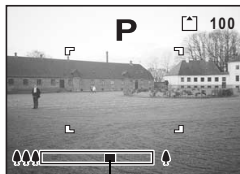

Zoom bar

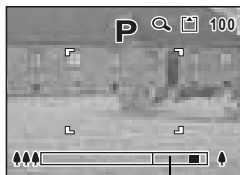

Digital zoom range

Saving the Zoom Position  p.70

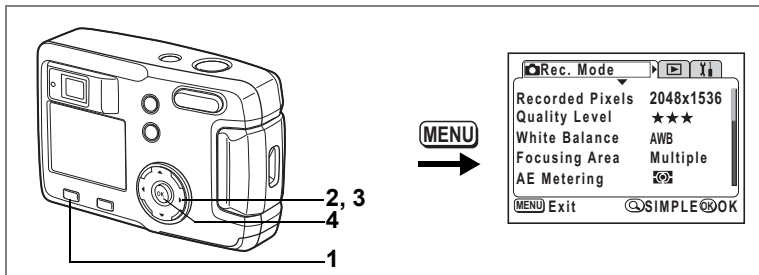

Enabling the Digital Zoom Function

4

Taking Pictures

1 Press the MENU button in Capture mode.

The SIMPLE menu or the [📷 Rec. Mode] menu will be displayed.

2 Use the four-way controller (▲▼) to select [Digital Zoom].

3 Press the four-way controller (▶) to select [On].

4 Press the OK button.

The camera is ready to take the picture.

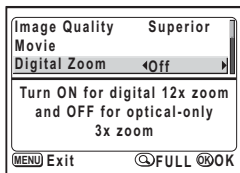

SIMPLE Menu

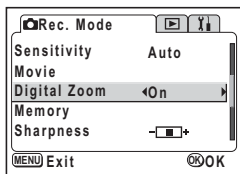

[📷 Rec. Mode] Menu

Saving the Digital Zoom Function Setting [p.70](#)

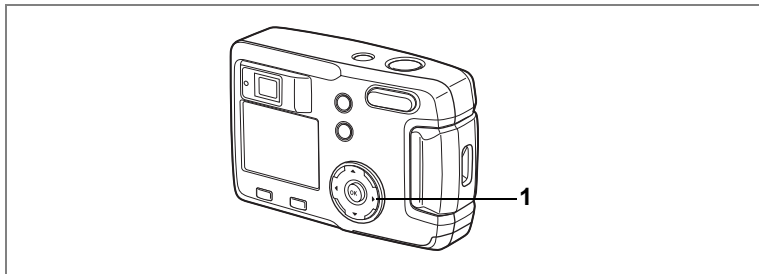

EV Compensation

You can take pictures that are intentionally overexposed or underexposed.

1 Press the four-way controller (◀▶) in Capture Mode.

To brighten, set positive +.

To darken, set negative -.

EV Compensation values can be selected in 1/3 EV steps in the range of -2.0 EV to +2.0 EV.

The EV Compensation setting is displayed on the LCD monitor.

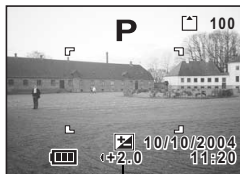

EV compensation value



When you press the four-way controller (◀▶) once, or when you set the setting to ± 0 , the display will disappear in two seconds.

Saving the EV Compensation Setting p.70

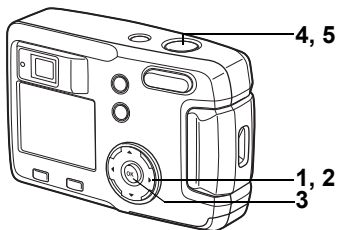

Taking Movie Pictures (Movie Picture Mode)

This mode enables you to take moving images. The recording time for a single movie is displayed at the top right of the LCD monitor. Sound cannot be recorded.

4

Taking Pictures

1 Press the four-way controller (▼) in Capture mode.

The virtual mode dial appears.



2 Use the four-way controller (◀▶) to select the Movie Picture mode (📹).

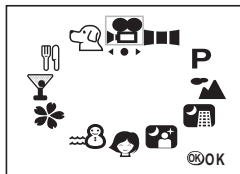

3 Press the OK button.

- 1 Flash off mark
- 2 Movie picture mode icon
- 3 Card / Built-in memory
- 4 Recordable time



4 Press the shutter release button.

Shooting will start. You can change the size of the image using the Zoom button.

▲ : Makes the subject bigger

◆◆ : Makes the subject smaller

5 Press the shutter release button.

Shooting will end. The remaining available recording time is displayed.

Keeping the shutter release button pressed

If you keep the shutter release button pressed for more than one second, pictures will be taken for as long as you keep the button pressed. Shooting stops when you remove your finger from the shutter release button.

Playing Back Movie Pictures  p.75



- The flash will not discharge in Movie Picture mode.
- Continuous Shooting and Multi Continuous Shooting are not possible in Movie Picture mode.
- Only [Autofocus mode] can be set in Movie Picture mode.

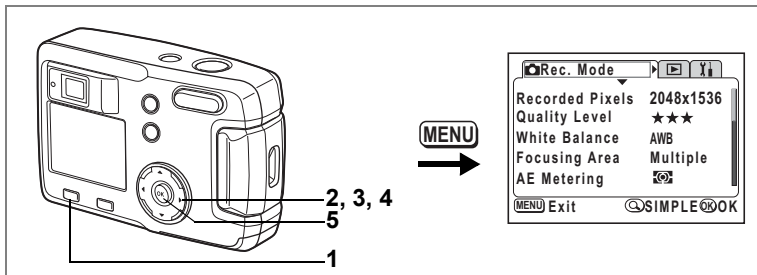

Changing the Recorded Pixels Setting When Taking Movie Pictures

4

Taking Pictures

In Movie Picture mode, you can choose the number of recorded pixels from [320×240] and [160×120].

The more pixels there are, the larger the image size but the shorter the recording time.

1 Press the MENU button in Capture mode.

The SIMPLE menu or the [📷 Rec. Mode] menu will be displayed.

2 Use the four-way controller (▲▼) to select [Movie].

3 Press the four-way controller (▶).

The Movie Setup screen will be displayed.

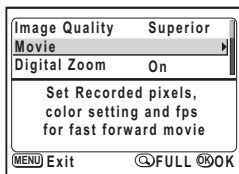

SIMPLE Menu

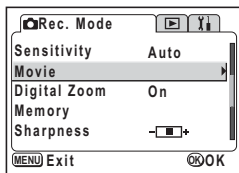

[📷 Rec. Mode] Menu

- 4** Use the four-way controller (◀▶) to change the recorded pixels.

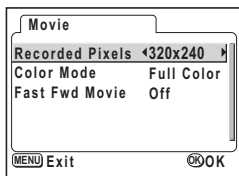

- 5** Press the OK button twice.

The camera is ready to take the movie picture.

Taking Movie Pictures p.62

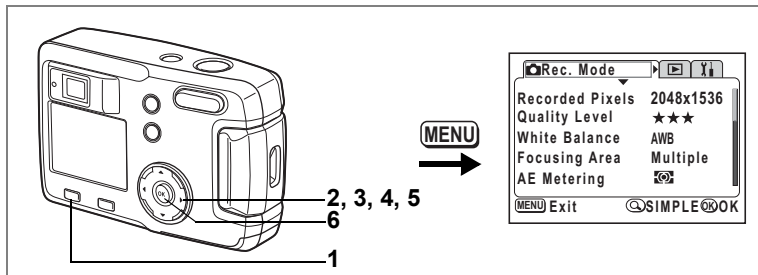

Changing the Color Mode Setting When Taking Movie Pictures

You can take a movie picture in one of three color mode settings: Full Color, B&W or Sepia.

1 Press the **MENU** button in Capture mode.

The SIMPLE menu or the [📷 Rec. Mode] menu will be displayed.

2 Use the four-way controller (▲▼) to select **[Movie]**.

3 Press the four-way controller (▶).

The Movie Setup screen will be displayed.

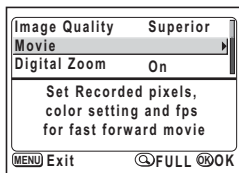

SIMPLE Menu

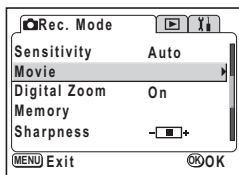

[📷 Rec. Mode] Menu

- 4** Use the four-way controller (▼) to select [Color Mode].

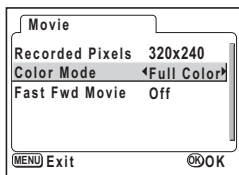

- 5** Use the four-way controller (◀▶) to change the [Color Mode].

- 6** Press the OK button twice.

The camera is ready to take the movie picture.

Taking Movie Pictures  p.62

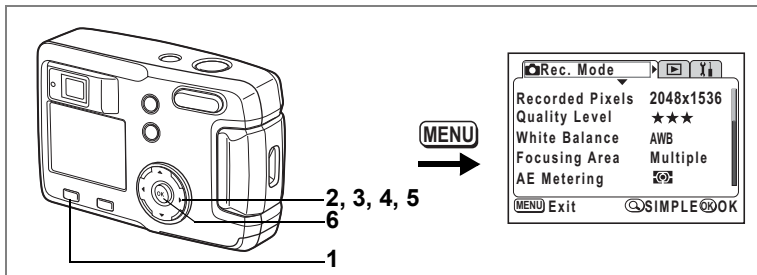

Taking Time-lapse Movie Pictures (Fast Fwd Movie)

4

This mode lets you take movie pictures at a delayed frame rate so that when you play the movie back, the action appears speeded up.

1 Press the MENU button in Capture mode.

The SIMPLE menu or the [Rec.Mode] menu will be displayed.

2 Use the four-way controller (▲▼) to select [Movie].

3 Press the four-way controller (▶).

The movie setup screen will be displayed.

4 Press the four-way controller (▼) to select [Fast Fwd Movie].

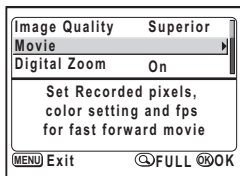

SIMPLE Menu

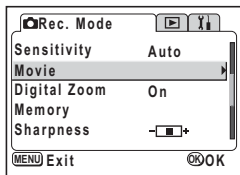

[Rec. Mode] Menu

5 Use the four-way controller (◀▶) to select [Off (×1)], [×2], [×5], [×10], [×20], [×50] or [×100].

6 Press the OK button twice.

The camera is ready to take the movie picture.

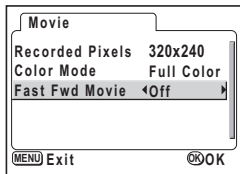





- Off (×1) is the normal setting for movie pictures (15 frames per second). Each time ×2 or ×5 is selected, the number of frames taken per second is reduced to 1/2 or 1/5.
- As movie pictures are normally played back at the rate of 15 frames per second, movies taken at ×2 appear to be played back twice as fast and movies taken at ×5 appear to be played back five times as fast.

Taking Movie Pictures p.62

Saving the Settings (Memory)

Saving the Menu Items (Memory)

You can choose whether you want the set values to be saved when the camera is turned off. If you select (On), the settings will be saved in the status they were in immediately before the camera was turned off. If you select (Off), the settings will be reset to the defaults when the camera is turned off.

Item	Description	Default Setting
Flash	The flash mode setting on the  button is saved.	<input checked="" type="checkbox"/>
White Balance	The [White Balance] setting on the [ Rec.Mode] menu is saved.	<input type="checkbox"/>
EV Compensation	The set EV compensation value is saved.	<input type="checkbox"/>
AE Metering	The [AE Metering] setting on the [ Rec.Mode] menu is saved.	<input type="checkbox"/>
Sensitivity	The [Sensitivity] setting on the [ Rec.Mode] menu is saved.	<input type="checkbox"/>
Digital Zoom	The [Digital Zoom] setting on the [ Rec.Mode] menu is saved.	<input checked="" type="checkbox"/>
Focus Mode	The focus mode setting is saved.	<input type="checkbox"/>
Zoom Position	The zoom position setting is saved.	<input type="checkbox"/>
Display	The LCD monitor display mode is saved.	<input type="checkbox"/>
File #	The file number is saved. If a new SD Memory Card is inserted, the sequential file number is assigned.	<input checked="" type="checkbox"/>



Menu items not included in [Memory] will also be saved in the settings selected on the menus for each function when the camera is turned off.

1 Press the MENU button in Capture mode.

The [📷 Rec. Mode] menu will be displayed.

Press the Zoom/📷/🔍 button if the SIMPLE menu is displayed. (p.28)

Full menu is displayed.

2 Use the four-way controller (▲▼) to select [Memory].

3 Press the four-way controller (▶).

The Memory menu will be displayed.

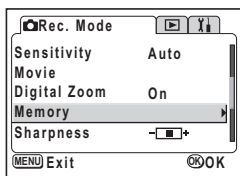

4 Use the four-way controller (▲▼) to select the item.

5 Use the four-way controller (◀▶) to select (On) or (Off).

6 Press the OK button twice.

The camera is ready to take the picture.

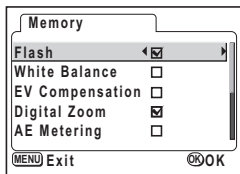

Playing Back Images

When an SD Memory Card has been inserted, images saved on the card are played back.

Images are played back from the Built-in memory when no card has been inserted.

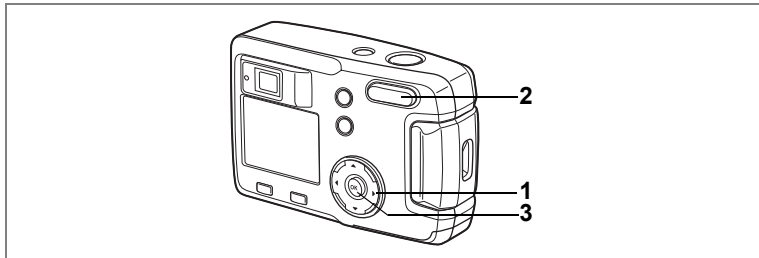

5 Playing Back Still Pictures

See "Playing Back Images" (p.24), or "Playing Back Previous or Next Images" (p.24).

Zoom Display

You can display images magnified up to eight times. A guide to operation is displayed on the LCD monitor during magnification.

- 1 Enter the Playback mode and choose the image you want to magnify with the four-way controller (◀▶).**
- 2 Press ▲/Q on the Zoom/📷/Q button.**

The image will be magnified (1× to 8×). If you keep pressing, the magnification of the image will be changed continuously.

- **The following operations can be performed while the magnified image is displayed.**

Four-way controller (▲▼◀▶) : moves the position to be magnified.

Zoom/📷/Q button (▲) : makes the subject bigger.

Zoom/📷/Q button (◆◆◆) : makes the subject smaller.



- 3 Press the OK button.**

Zoom playback will end.



Movie pictures cannot be magnified.

Displaying Shooting Information in Playback Mode

You can display information on the LCD monitor when playing back. The display mode can be changed by pressing the OK button.

Normal Display

Shooting information is displayed.

- 1 Playback mode
- 2 Folder name, File name
- 3 Protect icon
- 4 Card / Built-in memory icon
- 5 Four-way controller operation guide
- 6 Shooting date and time
- 7 Battery indicator

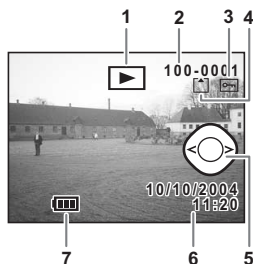

Histogram Display

The brightness distribution of the image is displayed. The horizontal axis shows the brightness (darkest at the left end and brightest at the right end) and the vertical axis shows the number of pixels.

- | | |
|---------------|-------------------|
| 1 Histogram | 2 Recorded pixels |
| 3 Quality | 4 White balance |
| 5 AE metering | 6 Sensitivity |
| 7 F number | 8 Shutter speed |

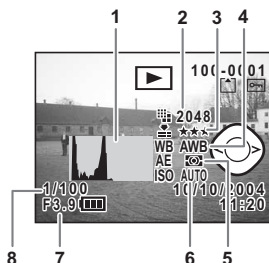

No Information Display

No shooting information is displayed.



Normal Display

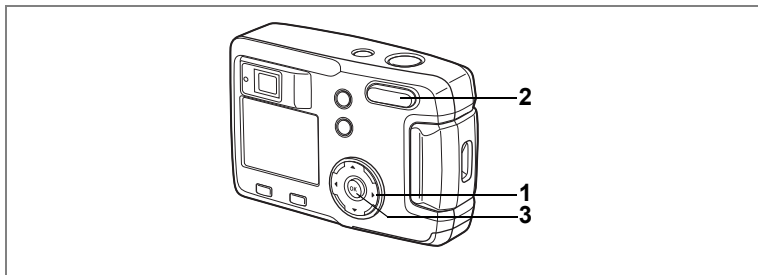

Nine Image Display

You can display nine images at the same time.

- 1 Enter the Playback mode and choose an image with the four-way controller (◀▶).**
- 2 Press ▲▲/☒ on the Zoom/☒/Q button.**

Nine images will be displayed with the selected image in the center.

Choose an image with the four-way controller (▲▼◀▶). When ten or more images have been recorded, if you press the four-way controller (▶) while the bottom right image is selected, the next nine images will be displayed, and if you press the four-way controller (◀) while the top left image is selected, the previous nine images will be displayed. Similarly, if you press the four-way controller (▲) while an image on the top row is selected, the previous nine images will be displayed, and if you press the four-way controller (▼) while an image on the bottom row is selected, the next nine images will be displayed.

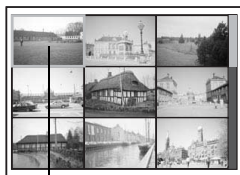

Selected image

- 3 Press the OK button.**

The screen will return to single-image display of the selected image. In case of movies, a single-frame image will be displayed.



- Movie picture files are displayed with 🎬.
- The screen will return to the full screen display of the selected image even if the MENU button, ☒ button, or Zoom/☒/Q button is pressed.

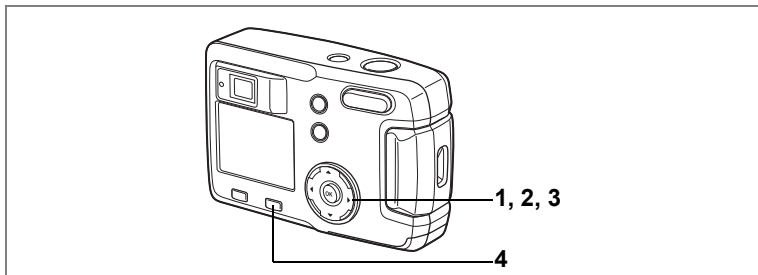

Playing Back Movie Pictures

You can play back movie pictures. A guide to operation is displayed on the LCD monitor during playback.

1 Enter the Playback mode and choose the movie picture you want to play back with the four-way controller (◀▶).

2 Press the four-way controller (▲).
Playback will start. The remaining playback seconds will be displayed.

- **The following operations can be performed during playback.**

- Four-way controller (◀): Reverse playback
- Four-way controller (▶): Forward playback
- Four-way controller (▲): Pause



- **The following operations can be performed while Pause is engaged.**

- Four-way controller (◀): Frame reverse
- Four-way controller (▶): Frame forward
- Four-way controller (▲): Releases the Pause function

3 Press the four-way controller (▼).

Movie playback will end and the screen will return to the first frame.

4 Press the [▶] Playback button.

The camera will return to Capture mode.

Copying Files

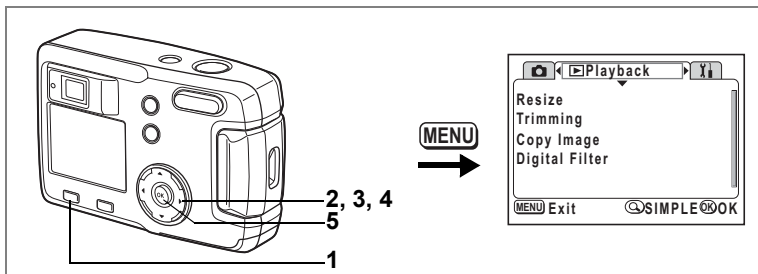

You can copy files from the Built-in memory to the SD Memory Card and vice versa. You cannot select this function if no card has been inserted in the camera.

When files are copied from the Built-in memory to the SD Memory Card, all the files are copied at once. When files are copied from the SD Memory Card to the Built-in memory, the files are checked one at a time before being copied.

1 Enter the Playback mode and press the MENU button.

The [▶ Playback] menu is displayed.

Press the Zoom/[Z]/[Q] button if the SIMPLE menu is displayed. (p.28)

2 Press the four-way controller (▼) to select [Copy Image].

3 Press the four-way controller (▶).

The Copy Image screen is displayed.

To copy from the Built-in memory to the SD Memory Card

4 Select [Built-in → SD] by pressing the four-way controller (▲).

5 Press the OK button.

All the files will be copied to the SD Memory Card.

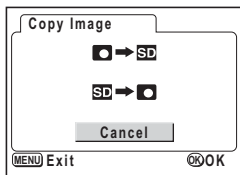

To copy from the SD Memory Card to the Built-in memory

- 4 Select [SD] → [OK] and press the OK button.**

The image selection screen appears.

- 5 Use the four-way controller (◀▶) to choose the image to copy.**

- 6 Press the OK button.**

The selected image will be copied to the Built-in memory.
Repeat steps 6 and 7 to copy more images.

- 7 Press the MENU button three times.**

The camera is ready to take or play back images.



When a file is copied from the SD Memory Card to the Built-in memory, it is assigned a new file name.



Be sure to turn the camera off before inserting or removing the SD Memory Card.

Deleting Images

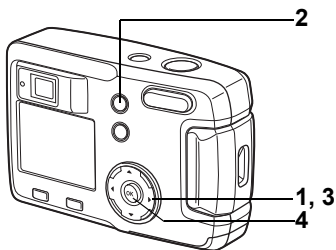

Deleting a Single Image

You can delete the images one at a time.



- Once deleted, images cannot be restored.
- Protected images cannot be deleted. (p.80)

- 1 Enter the Playback mode and choose the image to delete with the four-way controller (◀▶).**
- 2 Press the  button.**
The Delete screen will be displayed.
- 3 Press the four-way controller (▲) to select [Delete].**
- 4 Press the OK button.**
The selected image will be deleted.



You can also delete images from Instant Review (p.23).

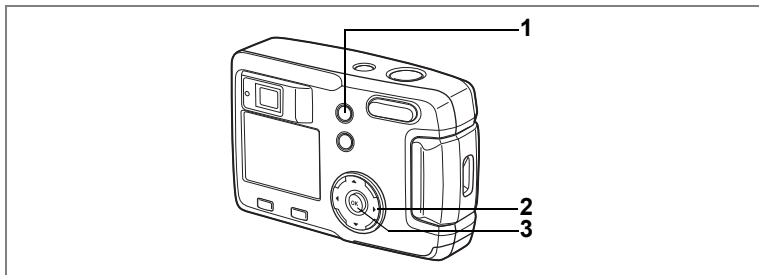

Deleting All Images

You can delete all the images at once.



- Once deleted, images cannot be restored.
- Protected images cannot be deleted. (p.80)

1 Enter the Playback mode and press the button twice.

The Delete All Images screen will be displayed.

2 Press the four-way controller () to select [Delete All].

3 Press the OK button.

All images will be deleted.



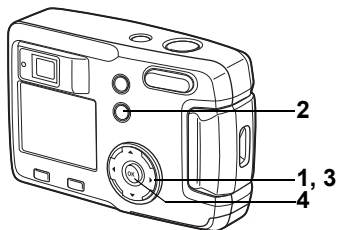

Protecting Images from Deletion (Protect)

You can protect images from being accidentally deleted.

- 1 Enter the Playback mode and choose the image to protect with the four-way controller (◀▶).**
- 2 Press the  button.**
The Protect screen will be displayed.
- 3 Press the four-way controller (▲) to select [Protect].**
- 4 Press the OK button.**
The image will be protected.



- Select [Unprotect] in step 3 to cancel the protect setting.
- If the image is protected, the  icon is displayed when the image is played back.

Protect All Images

You can protect all the images.

- 1 Enter the Playback mode and press the  button twice.**
The Protect All screen will be displayed.
- 2 Press the four-way controller (▲) to select [Protect All].**
- 3 Press the OK button.**
All the images will be protected.



Select [Unprotect] in step 2 to cancel the protect setting on all the images.



Even protected images will be deleted by formatting the SD Memory Card or Built-in memory.

Setting the Printing Service (DPOF)

You can print the images on the SD Memory Card using a DPOF (Digital Print Order Format) compatible printer or at a printing service.

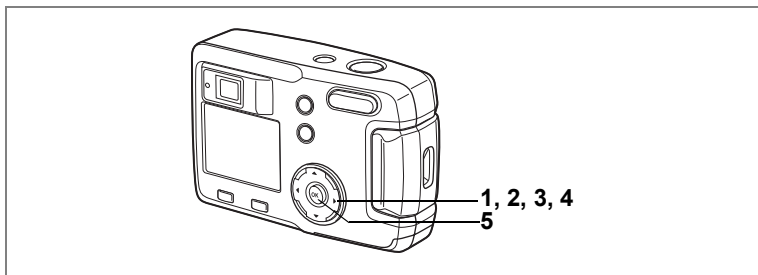

Printing Single Image

Set the following items for each image.

Copies: Set the number of prints up to a maximum of 99.

Date: Specify whether you want the date imprinted on the print or not.

- 1 Enter the Playback mode, use the four-way controller (◀▶) to choose the image for DPOF settings.**
- 2 Press the four-way controller (▲).**
The DPOF screen will be displayed.
- 3 Use the four-way controller (◀▶) to select the number of prints, then press the four-way controller (▼).**



4 Use the four-way controller (◀▶) to select [On] or [Off].

- (On) : The date will be imprinted.
- (Off) : The date will not be imprinted.

5 Press the OK button.

Prints can be set according to the settings.



- If DPOF settings have already been made for an image, the previously set number of prints and On / Off date setting will be displayed.
- To cancel DPOF settings, set the number of prints to 00 and press the OK button.



- DPOF settings are not available for movie pictures.
- Depending on the printer or printing equipment at the photo processing lab, the date may not be imprinted on the pictures even if the DPOF setting was made.

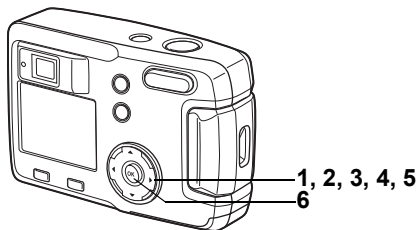

Printing All Images

- 1 Enter the Playback mode and press the four-way controller (▲).**

The DPOF screen will be displayed.

- 2 Press the four-way controller (▲).**

The DPOF (All Images) screen will be displayed.

- 3 Use the four-way controller (◀▶) to select the number of prints.**

You can print up to 99 copies.

- 4 Press the four-way controller (▼).**

- 5 Use the four-way controller (◀▶) to select [On] or [Off].**

(On) : The date will be imprinted.

(Off) : The date will not be imprinted.

- 6 Press the OK button.**

Prints can be made according to the settings.



- The settings for single images will be cancelled.
- When you specify the number of prints in the DPOF settings, the number applies to all the images. Before printing, check that the number is correct.
- DPOF settings are not possible for movie pictures.
- To cancel DPOF settings, with [All Images] selected, set the number of prints to 00.

Printing Directly from the Camera Connected to a Printer (PictBridge)

When you use the USB cable provided with the camera (I-USB6) to connect the camera to a printer that supports PictBridge, you can print images directly from the camera without using a PC. The selection of the images to print and the number of prints are set using the controls on the camera after the camera has been connected to the printer.



- We recommend that you use the AC adapter D-AC5 (optional) while the camera is connected to a printer. The printer may not operate correctly or image data may be damaged if the power for the battery runs low while the camera is connected to the printer.
- The viewfinder lamp blinks slowly while data is being transferred from the camera to the printer. Do not disconnect the USB cable during data transfer.

5



Depending on the type of printer, camera settings (such as image quality and DPOF settings) may not be applied.

Playback / Deleting

Connecting the Camera to the Printer

- 1 Select [PictBridge] in [USB Connection] on the [Set-up] menu.**

☞ “Changing the USB Connection Mode” (p.99)

- 2 Connect the camera and printer with the USB cable provided.**

The print mode selection screen appears.

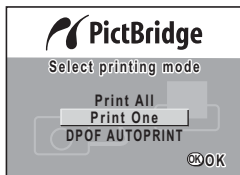

Do not connect the camera to your PC while [PictBridge] is selected for the USB connection mode.

Printing Single Image

- 1 **Select [Print One] by pressing the four-way controller (▲▼).**

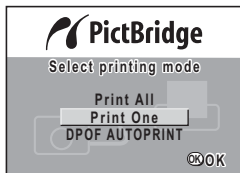

- 2 **Press the OK button.**

The Print screen appears.

- 3 **Use the four-way controller (◀▶) to choose the image to print.**

- 4 **Use the four-way controller (▲▼) to select the number of prints.**

You can set up to 10 prints.



- 5 **Use the [▶] Playback button to select [On] or [Off].**

(On) : The date will be imprinted.

(Off) : The date will not be imprinted.

- 6 **Press the OK button.**

The image is printed using the selected settings.

The message "Continue printing ?" is displayed after the image has been printed. Press the OK button to return to step 3 and continue printing. Press the MENU button to end printing.

Press the MENU button to stop printing halfway.

Printing All Images

1 Select [Print All] by pressing the four-way controller (▲▼).

2 Press the OK button.

The Print All screen appears.

Use the four-way controller (◀▶) to check the images.

3 Use the four-way controller (▲▼) to select the number of prints.

You can select the number of prints.

4 Press the  Playback button to select (On) or (Off).

(On) : The date will be imprinted.

(Off) : The date will not be imprinted.

5 Press the OK button.

Prints can be made according to the settings.

The message "Continue printing ?" is displayed after the image has been printed. Press the OK button to return to step 3 and continue printing.

Press the MENU button to stop printing halfway.

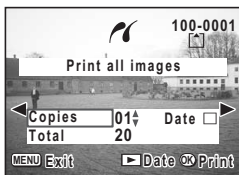

Printing Using the Printing Service Settings (DPOF)

1 Select [DPOF AUTOPRINT] by pressing the four-way controller (▲▼).

2 Press the OK button.

The DPOF Printing screen appears.

Use the four-way controller (◀▶) to check the images and printing service settings.

3 Press the OK button.

The selected image is printed using the printing service settings set for the image.

The message "Continue printing ?" is displayed after the image has been printed. Press the OK button to return to step 3 and continue printing.

Press the MENU button to stop printing halfway.

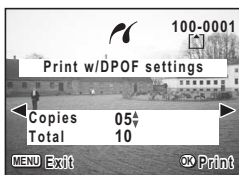

Disconnecting the Camera from the Printer

After you have finished printing images, disconnect the camera from the printer.

- 1 Turn the camera off.**
- 2 Disconnect the USB cable from the camera.**
- 3 Disconnect the USB cable from the printer.**



If you press the MENU button while the “Continue printing ?” message is displayed, the message “Safely remove USB cable” is displayed.

When you disconnect the USB cable from the camera, the camera automatically switches to Capture mode.

Editing Images

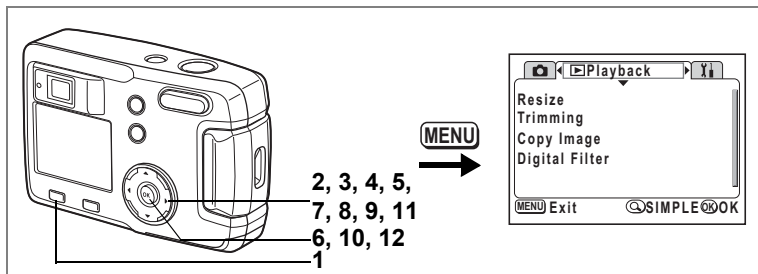

Changing the Image Size

By changing the size and quality of a selected image, you can make the file smaller than the original. After changing the size, the image can be saved as a new image or written over the original image.

- 1 Press the MENU button.**
- 2 Press the four-way controller (▶).**
The [▶ Playback] menu will be displayed.
If the SIMPLE menu is displayed, press the Zoom/☒/Q button and press the four-way controller (▶).
- 3 Use the four-way controller (▲▼) to select [Resize].**
- 4 Press the four-way controller (▶).**
The Resize screen will be displayed.



- 5 Use the four-way controller (◀▶) to choose the image to resize.**

6 Press the OK button.



7 Use the four-way controller (◀▶) to select [Recorded Pixels].

8 Press the four-way controller (▼).

The select frame moves to [Quality Level].

9 Use the four-way controller (◀▶) to select [Quality Level].

10 Press the OK button.

11 Use the four-way controller (▲▼) to select [Overwrite] or [Save as].

12 Press the OK button.

The resized image will be saved.



- Movie pictures cannot be resized.
- You cannot select a larger size than that of the original image.
- You cannot select a higher quality than that of the original image.

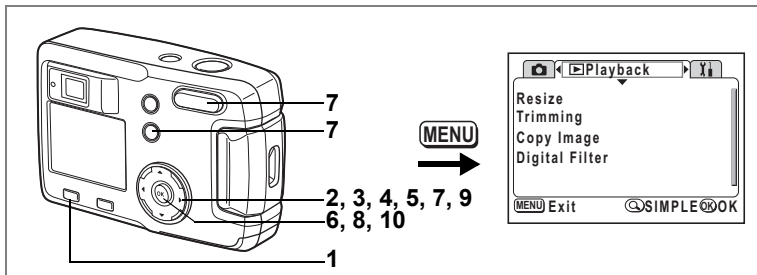

Trimming Images

You can trim part of a picture and save it as a separate image.

- 1 Press the MENU button.**
- 2 Press the four-way controller (▶).**
The [▶ Playback] menu will be displayed.
If the SIMPLE menu is displayed, press the Zoom/☒/Q button and press the four-way controller (▶).
- 3 Use the four-way controller (▲▼) to select [Trimming].**
- 4 Press the four-way controller (▶).**
The images that can be trimmed will be displayed.
- 5 Use the four-way controller (◀▶) to choose the image to trim.**
- 6 Press the OK button.**
The Trimming screen will be displayed.

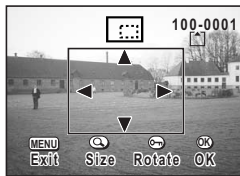

7 Trim the image.

• Operations available on the Trimming screen.

Zoom/☒/Q button:

Changes the size of the image

↔ button:

Toggles between horizontal and vertical of the image

Four-way controller (▲▼◀▶): Moves the trimming position up, down, right and left

MENU button:

Returns to the screen for selecting an image to trim

- 8 Press the OK button.
- 9 Use the four-way controller (◀▶) to select the quality level after trimming.

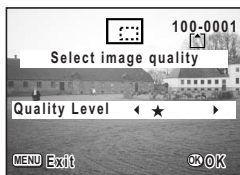

10 Press the OK button.

The trimmed image will be saved as a separate image.



- Movie pictures cannot be trimmed.
- You cannot select a higher quality than that of the original image.

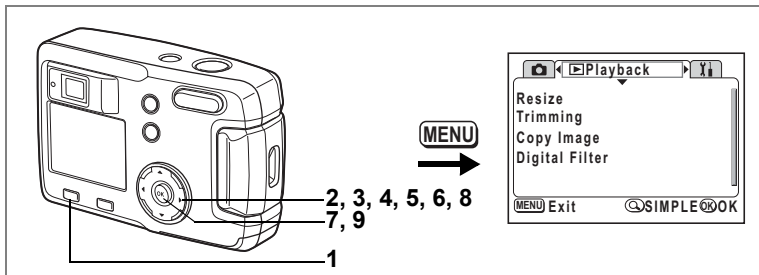

Editing Images with Digital Filters

The filters consist of color filters such as red, blue, and green, and a brightness filter that adjusts the brightness of the image. In Digital Filter mode, these filters can be used to edit an image.

● Color Filters

Eight color filters are provided: black-and-white, sepia, red, pink, violet, blue, green and yellow. When you select a color filter in the Digital Filter mode, the display on the LCD monitor is filtered with the selected color, and the images are saved in that color.

● Brightness Filter

Images edited with the brightness filter can be brightened or darkened and saved.

- 1 Press the MENU button.**
- 2 Press the four-way controller (▶).**

The [▶ Playback] menu will be displayed.

If the SIMPLE menu is displayed, press the Zoom/☒/Q button and press the four-way controller (▶).

- 3 Use the four-way controller (▲▼) to select [Digital Filter].**

- 4 Press the four-way controller (▶).**

The Digital Filter setup screen will be displayed.

- 5 Use the four-way controller (◀▶) to choose the image to edit.**

- 6 Use the four-way controller (▲▼) to choose the desired digital filter.**

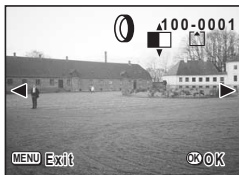

The filtered image will be displayed on the LCD monitor.

- **Operations available with the brightness filter** ☒
Zoom/☒/Q button (▲): Makes the image brighter
Zoom/☒/Q button (▼): Makes the image darker

- 7 Press the OK button.**
- 8 Use the four-way controller (▲▼) to select [Overwrite] or [Save as].**
- 9 Press the OK button.**

The image edited with the digital filters will be saved.

Camera Settings

How to recall the [Y] Set-up menu

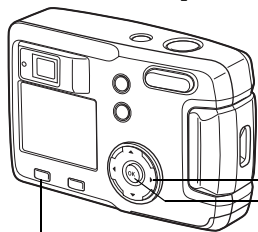

Four-way controller
OK button
MENU button

MENU

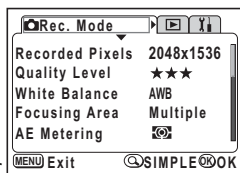

Formatting an SD Memory Card or the Built-in Memory

Formatting will delete all the data on the SD Memory Card if you are using a card, and all the data in the Built-in memory if there is no card inserted.



- Do not open the card cover while the SD Memory Card is being formatted. The card may be damaged and become unusable.
- SD Memory Cards formatted on a PC or device other than the camera cannot be used. Be sure to format the card with the camera.
- Formatting will delete protected data too.

- 1 Select [Format] on the SIMPLE menu or the [Y] Set-up menu.**
- 2 Press the four-way controller (▶).**
The Format screen will be displayed.
- 3 Press the four-way controller (▲▼) to select [Format].**
- 4 Press the OK button.**

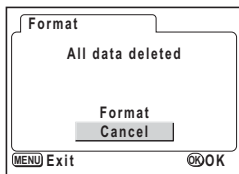

Formatting will start. When formatting is completed, the camera is ready to take pictures.

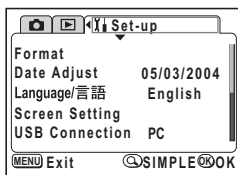

Changing the Date Style and Date / Time

You can change the initial date and time settings.

You can also set the style in which the date is displayed on the camera. Choose [mm/dd/yy], [dd/mm/yy] or [yy/mm/dd].

- 1 Select [Date Adjust] on the SIMPLE menu or the [Set-up] menu.**
- 2 Press the four-way controller (▶).**
The Date Adjust screen will be displayed.

See “Setting the Date and Time” (p.19) for the setting procedure.

Changing the Display Language

You can change the language in which the menus, error messages, etc. are displayed.

- 1 Select [Language/言語] on the SIMPLE menu or the [Set-up] menu.**
- 2 Press the four-way controller (▶).**
- 3 Use the four-way controller (▲▼◀▶) to select the language.**
- 4 Press the OK button twice.**

The camera is ready to take or play back images.



How to recall the [Yi Set-up] menu

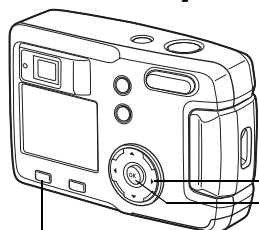

Four-way controller
OK button
MENU button

MENU

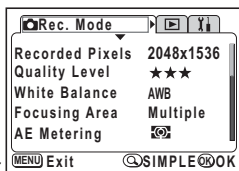

Changing the Start-up Screen / Background Color

- 1 Select [Screen Setting] on the SIMPLE Menu or the [Yi Set-up] menu.**
- 2 Press the four-way controller (▶).**
The Display Setting screen will be displayed.

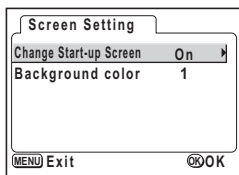

Changing the Start-up Screen

You can display an image recorded with the camera as the start-up screen when the camera is turned on.

- 3 Select [Change Start-up Screen] and press the four-way controller (▶).**
The changing start-up screen will be displayed.
- 4 Use the four-way controller (◀▶) to select [On] or [Off].**
 (On) : Displays the start-up screen
 (Off) : Hides the start-up screen
- 5 Press the  button.**
- 6 Use the four-way controller (◀▶) to choose the image you want to display as the start-up screen.**
- 7 Press the OK button four times.**
The camera is ready to take or play back images.

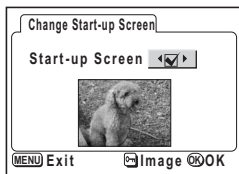

Once the start-up screen has been set, it will not be deleted even if the original image is deleted or the SD Memory Card or Built-in memory is formatted. To cancel the setting, reset it. (p.99)

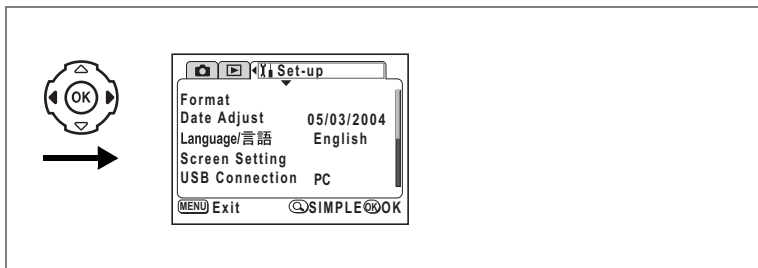

Setting the Background Color

You can set the background design and color displayed on the LCD monitor. There are six colors to choose from.

- 3 Press the four-way controller (▼) to select [Background color].**

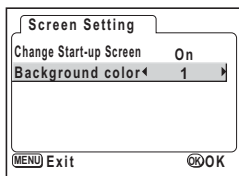

- 4 Use the four-way controller (◀▶) to select the background color.**

The background design and color of the menus will change.

- 5 Press the OK button twice.**

The camera is ready to take or play back images.

How to recall the [Yi Set-up] menu

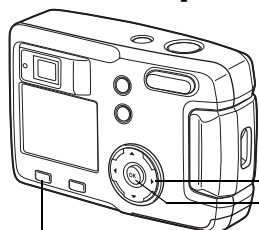

Four-way controller
OK button
MENU button

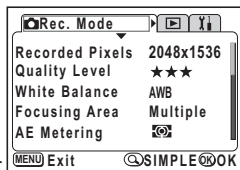

Sleep Timeout

You can set the LCD monitor to turn off automatically when no operation is performed for a fixed time.

- 1 Select **[Sleep Timeout]** on the **[Yi Set-up]** menu.
- 2 Use the four-way controller (◀▶) to select **[30sec]**, **[1min]**, **[2min]** or **[Off]**.
- 3 Press the **OK** button.

The camera is ready to take or play back images.



This function will not work when the USB cable is connected.

Setting Auto Power Off

You can set the camera to turn off automatically when no operation is performed for a fixed time.

- 1 Select **[Auto Power Off]** on the **[Yi Set-up]** menu.
- 2 Use the four-way controller (◀▶) to select **[3 min]**, **[5min]** or **[Off]**.
- 3 Press the **OK** button.

The camera is ready to take or play back images.



The Auto Power Off function will not work when the USB cable is connected.

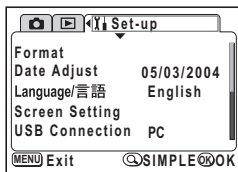

Changing the USB Connection Mode

The USB Connection mode is changed depending on whether the USB cable is to be connected to a printer (PictBridge) or a computer.

- 1 Select [USB Connection] on the [Set-up] menu.**
- 2 Use the four-way controller (◀▶) to select [PC] or [PictBridge].**
- 3 Press the OK button.**

The camera is ready to be connected to a computer or printer.



Do not connect the camera to your PC while [PictBridge] is selected for the USB connection mode.

Resetting to Default Settings [Reset]

You can reset all the settings other than the date / time and language/言語.

- 1 Select [Reset] on the [Set-up] menu.**
- 2 Press the four-way controller (▶).**
The Reset screen will be displayed.
- 3 Use the four-way controller (▲) to select [Reset].**
- 4 Press the OK button.**

The camera is ready to take or play back images.



The SIMPLE menu is displayed by pressing the MENU button after performing the above resetting.

Messages

Messages such as the following may be displayed on the LCD monitor during camera operation.

Compression error	Compression of the image you captured has failed. Change the recorded pixels or quality levels, and take the picture again.
Memory card full Built-in Memory full	The SD Memory Card or the Built-in memory is full and no more images can be saved. Insert a new SD Memory Card or delete. (p.15, 78) Change the quality / size and try again. (p.41, 42)
Data being recorded	The image is being recorded on the SD Memory Card or in the Built-in memory.
Image folder could not be created	The largest file number has been assigned to an image and no more images can be saved. Insert a new SD Memory Card or format the SD Memory Card or Built-in memory. (p.94)
No image	There are no images on the SD Memory Card or in the Built-in memory.
Camera cannot display this image	You are trying to play back an image in a format not supported by this camera. You may be able to display it on another brand of camera or PC.
Image protected	The image you are trying to delete is a protected image.
Setting being recorded	The image protect setting or DPOF setting is being changed.
Settings not stored	The SD Memory Card is full, and no more DPOF settings can be made. Delete any unwanted images and try to make the settings again.
Deleting	The image is being deleted.
Battery depleted	The battery is exhausted. Replace the battery. (p.12)
Memory card error	Shooting and playback are impossible due to a problem with the SD Memory Card. Try displaying on a PC.
Built-in memory error Format the Built-in memory	This is displayed when images cannot be recorded or played back due to a malfunction in the Built-in memory. Try displaying on a PC.









Card not formatted	The SD Memory Card you have inserted is unformatted or has been formatted on a PC or other device and is not compatible with the camera. (p.94)
Formatting	The SD Memory Card or Built-in memory is being formatted. (p.94)
Card locked	The SD Memory Card write protect switch is in the [LOCK] position. (p.16)

Messages such as the following may be displayed on the LCD monitor when using the PictBridge function.

No paper	There is no paper in the connected printer.
No ink	There is no ink in the connected printer.
Printer error	The connected printer sent an error message to the camera.
Data error	The connected printer sent a data error message to the camera.
Paper stuck	The paper in the connected printer has jammed.

Troubleshooting

Problem	Cause	Remedy
Power will not come on	Battery is not installed	Check battery is installed. If not, install battery.
	Battery / card cover is open	Close the battery / card cover.
	Battery is installed incorrectly	Check orientation of battery. Reinsert battery according to the ⊕ ⊖ symbols in the battery compartment. (p.12)
	Battery power is low	Insert a charged battery or use the AC adapter.
No image on the LCD monitor	Camera is connected to PC with USB cable	The LCD monitor is always off when the camera is connected to a PC.
	Image is displayed but is hard to see	Images on the LCD monitor may be hard to see when taking pictures outside in sunlight.
Shutter will not release	Flash is charging	When viewfinder lamp blinks red, flash is charging and no pictures can be taken. The lamp turns off when charging is completed.
	No available space on SD Memory Card or in Built-in memory	Insert an SD Memory Card with available space, or delete unwanted images. (p.15, 78)
	Recording	Wait until recording is finished.

Problem	Cause	Remedy
Subject is not in focus	Subject difficult to focus on	Subjects difficult to focus on using autofocus: objects with little contrast (blue sky, white walls, etc.), dark objects, finely patterned objects, fast-moving objects, scenery through window or net, etc. Lock focus on another object located at same distance (press shutter release button halfway), then aim at target and press shutter release button fully.
	Subject is not in focusing area	Position subject in AF frame (focusing area) in middle of LCD monitor. If the subject is outside the focusing area, aim the camera at the subject and lock the focus (press shutter release button halfway), then compose picture and press the shutter release button fully.
	Subject is too close	Set the focus mode on  . (p.38)
	Focus mode is set on 	Normal pictures will be out of focus if taken with focus mode set on  .
Picture is dark	Subject is too far away in a dark environment, such as a night scene	Picture becomes dark if subject is too far away. Take picture within range of flash.
	Background is dark	When taking a picture of a person against dark background, such as night scene, the person may appear clearly while the background appears dark because the flash does not reach the background. Set to  or  mode on the virtual dial screen to ensure both person and background are clear. (p.52)
Flash does not discharge	Flash mode is set to Off	Set to Auto or  . (p.40)
	The Capture mode is set to  , Continuous Shooting or  mode	Flash will not discharge in these modes.

Main Specifications

Type	Fully automatic compact-type digital still camera with built-in zoom lens	
Effective Pixels	3.2 megapixels	
Sensor	3.34 megapixels (total pixels), 1/2.7 inch interline transfer CCD with a primary color filter	
Recorded Pixels	Still	2048×1536 pixels, 1600×1200 pixels, 1024×768 pixels, 640×480 pixels
	Movie	320×240 pixels, 160×240 pixels, without sound
Sensitivity	Auto, Manual (Equivalent to ISO50, ISO100, ISO200, and ISO400)	
File Format	Still	JPEG (Exif2.2), DCF, DPOF
	Movie	MOV (QuickTime Motion JPEG), approx. 15 fps, No sound, Full Color / Sepia / B&W switchable
Quality Level	Best, Better, Good	
Storage Medium	Built-in memory (approx. 16 MB), SD Memory Card	

Image Storage Capacity

Recorded Pixels \ Quality Level	Quality Level			Movie Pictures (320×240)	Movie Pictures (160×120)
	Best	Better	Good		
2048×1536	7	13	19	42 sec.	155 sec.
1600×1200	12	20	28		
1024×768	25	46	58		
640×480	54	84	103		

- When using the Built-in memory (16MB)

White Balance	Auto, Daylight, Shade, Tungsten light, Fluorescent light	
Lens	Focal Length	5.8mm - 17.4mm (Equivalent to 38 - 114mm in 35mm format)
	Maximum Aperture	f/2.9 - f/5
	Lens Composition	7 elements in 6 groups (3 aspherical elements)
	Zoom Type	Electrically driven
	Picture Range	Approx. 28.6mm × 21.2mm (full screen) (Using macro mode or manual focus at a distance of 2cm to subject, WIDE position)
Digital Zoom	Capture Mode	Max 4× (Combines with 3× optical zoom to give zoom magnification equivalent to 12×)
Viewfinder	Type	Real optical zoom viewfinder
	Magnification	Wide 0.39×, Tele 1.01×
LCD Monitor	1.6-inch TFT color LCD with backlight, 85 kilo pixels	
Playback Functions	Single-frame, 9-frame index, enlargement (max. 8×), scroll, movie playback, histogram display, trimming, resizing, digital filters	

Focusing System	Type	TTL contrast detection system by sensor
	Focusing Range (From lens front)	Normal: 0.5m - ∞ (full zoom range) Macro: 0.02m - 0.6m (Wide only) Infinity-landscape: ∞ (full zoom range)
	Focus Lock	By half-pressing shutter release button
Manual Focus	0.02m - ∞ (Wide only), 0.5m - ∞ (full zoom range, w/o Wide)	
Exposure Mechanism	AE Metering	TTL metering by sensor (multi-segment, center-weighted, spot)
	Exposure Modes	Program, Picture mode, Movie, Panorama Assist
	EV Compensation	± 2 EV (Can be set in 1/3EV steps)
	Movie	Recording time by vacant memory
Shutter	Type	Electronic / mechanical shutter
	Speed	Approx. 1/2000 sec. - 2 sec.
Flash	Type	Automatic flash with red-eye reduction function
	Flash Modes	Auto, Flash Off, Flash On, Auto+Red-eye reduction, Flash On+Red-eye reduction
	Working Range	Wide : Approx. 0.2m - 2.9m w / sensitivity AUTO Tele : Approx. 0.5m - 1.7m w / sensitivity AUTO
Drive Modes	Single-frame Shooting, Self-timer Shooting, Continuous Shooting, Multi Continuous Shooting	
Self-timer	Electronic control type, delay time: approx. 2 sec./10 sec.	
Time function	Time setting	
Power Supply	One Lithium battery CR-V3, two AA batteries (Alkaline, Ni-MH, Lithium), AC Adapter (optional)	
Battery Life	Approx. 600 images	(with LCD monitor on, flash fired for 50% of shots and using a lithium battery CR-V3, in accordance with PENTAX measuring conditions)
In / Out Ports	USB terminal (PC communication type USB1.1), external power supply terminal	
Direct Printing	PictBridge supported	
Size	93.5 (W) \times 61.5 (H) \times 36 (D) mm (excluding projections)	
Weight	130 g (excluding batteries and SD Memory Card)	
Weight when shooting	180 g (including batteries and SD Memory Card)	
Accessories	AA batteries (2), USB cable, software (CD-ROM), strap, operating manual	

Optional Accessories

The following optional accessories are available for this camera.

AC Adapter D-AC5

Camera Case O-CC2

Strap O-ST18 (*)

USB Cable I-USB6 (*)

Items marked with (*) are the same products provided with the camera.

Memo

WARRANTY POLICY

All PENTAX cameras purchased through authorized bona fide photographic distribution channels are guaranteed against defects of material or workmanship for a period of twelve months from date of purchase. Service will be rendered, and defective parts will be replaced without cost to you within that period, provided the equipment does not show evidence of impact, sand or liquid damage, mishandling, tampering, battery or chemical corrosion, operation contrary to operating instructions, or modification by an unauthorized repair shop. The manufacturer or its authorized representatives shall not be liable for any repair or alterations except those made with its written consent and shall not be liable for damages from delay or loss of use or from other indirect or consequential damages of any kind, whether caused by defective material or workmanship or otherwise; and it is expressly agreed that the liability of the manufacturer or its representatives under all guarantees or warranties, whether expressed or implied, is strictly limited to the replacement of parts as hereinbefore provided. No refunds will be made on repairs by non-authorized PENTAX service facilities.

Procedure During 12-month Warranty Period

Any PENTAX which proves defective during the 12-month warranty period should be returned to the dealer from whom you purchased the equipment or to the manufacturer. If there is no representatives of the manufacturer in your country, send the equipment to the manufacturer, with postage prepaid. In this case, it will take a considerable length of time before the equipment can be returned to you owing to the complicated customs procedures required. If the equipment is covered by warranty, repairs will be made and parts replaced free of charge, and the equipment will be returned to you upon completion of servicing. If the equipment is not covered by warranty, regular charges of the manufacturer or of its representatives will apply. Shipping charges are to be borne by the owner. If your PENTAX was purchased outside of the country where you wish to have it serviced during the warranty period, regular handling and servicing fees may be charged by the manufacturer's representatives in that country. Notwithstanding this, your PENTAX returned to the manufacturer will be serviced free of charge according to this procedure and warranty policy. In any case, however, shipping charges and customs clearance fees to be borne by the sender. To prove the date of your purchase when required, please keep the receipt or bills covering the purchase of your equipment for at least a year. Before sending your equipment for servicing, please make sure that you are sending it to the manufacturer's authorized representatives or their approved repair shops, unless you are sending it directly to the manufacturer. Always obtain a quotation for the service charge, and only after you accept the quoted service charge, instruct the service station to proceed with the servicing.

- This warranty policy does not affect the customer's statutory rights.
- The local warranty policies available from PENTAX distributors in some countries can supersede this warranty policy. Therefore, we recommend that you review the warranty card supplied with your product at the time of purchase, or contact the PENTAX distributor in your country for more information and to receive a copy of the warranty policy.



The CE Mark is a Directive conformity mark of the European Community.

For customers in USA**STATEMENT OF FCC COMPLIANCE**

This device complies with Part 15 of the FCC Rules. Operation is subject to the following two conditions: (1) This device may not cause harmful interference, and (2) this device must accept any interference received, including interference that may cause undesired operation.

Changes or modifications not approved by the party responsible for compliance could void the user's authority to operate the equipment.

This equipment has been tested and found comply with the limits for a Class B digital device, pursuant to part 15 of the FCC Rules.

These limits are designed to provide reasonable protection against harmful interference in a residential installation. This equipment generates, uses and can radiate frequency energy and, if not installed and used in accordance with the instructions, may cause harmful interference to radio communications. However, there is no guarantee that interference will not occur in a particular installation.

If this equipment does cause harmful interference to radio or television reception, which can be determined by turning the equipment off and on, the user is encouraged to try to correct the interference by one or more of the following measures:

- Reorient or relocate the receiving antenna.
Increase the separation between the equipment and receiver.
Connect the equipment into an outlet on a circuit different from that to which the receiver is connected.
- * Consult the dealer or an experienced radio / TV technician for help.

For customers in Canada

This Class B digital apparatus meets all requirements of the Canadian Interference - Causing Equipment Regulations.

Pour les utilisateurs au Canada

Cet appareil numérique de la classe B respecte toutes les exigences du Règlement sur le matériel brouilleur du Canada.

Declaration of Conformity
According to 47CFR, Parts 2 and 15 for
Class B Personal Computers and Peripherals

We: PENTAX Imaging Company
A Division of PENTAX of America, Inc.

Located at: 600 12th Street, Suite 300
Golden, Colorado 80401 U.S.A.
Phone: 303-799-8000 FAX: 303-790-1131

Declare under sole responsibility that the product identified herein, complies with 47CFR Parts 2 and 15 of the FCC rules as a Class B digital device. Each product marketed, is identical to the representative unit tested and found to be compliant with the standards. Records maintained continue to reflect the equipment being produced can be expected to be within the variation accepted, due to quantity production and testing on the statistical basis as required by 47CFR §2.909. Operation is subject to the following two conditions: (1) This device may not cause harmful interference, and (2) This device must accept any interference received, including interference that may cause undesired operation. The above named party is responsible for ensuring that the equipment complies with the standards of 47CFR §15.101 to §15.109.

Product Name: PENTAX Digital Still Camera

Model Number: Optio 30

Contact person: Customer Service Manager

Issued Date and Place: February, 2004, Colorado

Revised Date and Place: April, 2004, Colorado
(Revised for Company Name change)

Memo

Memo

- PENTAX Corporation** 2-36-9, Maeno-cho, Itabashi-ku, Tokyo 174-8639, JAPAN
(<http://www.pentax.co.jp/>)
- PENTAX Europe GmbH (European Headquarters)**
Julius-Vosseler-Strasse, 104, 22527 Hamburg, GERMANY
(HQ - <http://www.pentaxeurope.com>)
(Germany - <http://www.pentax.de>)
- PENTAX U.K. Limited** PENTAX House, Heron Drive, Langley, Slough, Berks
SL3 8PN, U.K.
(<http://www.pentax.co.uk>)
- PENTAX France S.A.S.** 12/14, rue Jean Poulmarch, 95106 Argenteuil Cedex, FRANCE
- PENTAX Benelux B.V.** (for Netherlands)
Spinveld 25, 4815 HR Breda, NETHERLANDS
(<http://www.pentax.nl>)
(for Belgium & Luxembourg)
Weiveldlaan 3-5, 1930 Zaventem, BELGIUM
(<http://www.pentax.be>)
- PENTAX (Schweiz) AG** Widenholzstrasse 1 Postfach 367 8305 Dietlikon, SWITZERLAND
(<http://www.pentax.ch>)
- PENTAX Scandinavia AB** P.O. Box 650, 75127 Uppsala, SWEDEN
(<http://www.pentax.se>)
- PENTAX Imaging Company**
A Division of PENTAX of America, Inc.
600 12th Street, Suite 300
Golden, Colorado 80401, U.S.A.
(<http://www.pentax.com>)
- PENTAX Canada Inc.** 1770 Argentia Road Mississauga, Ontario L5N 3S7,
CANADA
(<http://www.pentaxcanada.ca>)

<http://www.digital.pentax.co.jp>



for your
precious moments

- Printed on recycled paper
- Specifications and external dimensions are subject to change without notice.