

# PENTAX™

Digital Camera

## Optio SV

### Operating Manual

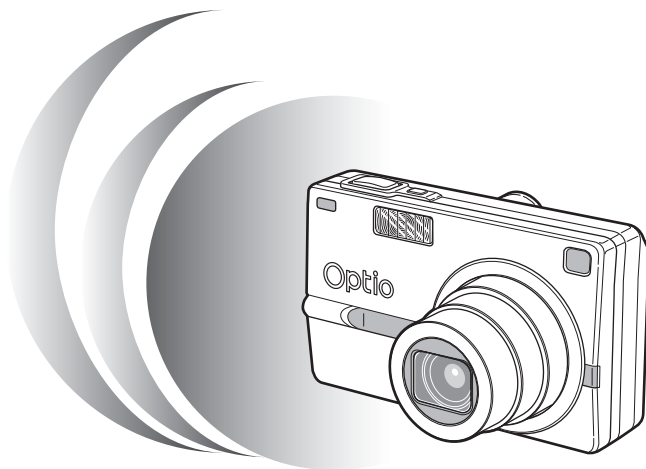

To ensure the best performance from your camera, please read the Operating Manual before using the camera.

Thank you for purchasing the PENTAX Optio SV Digital Camera. Please read this manual before using the camera in order to get the most out of all the features and functions. Keep this manual safe, as it can be a valuable tool in helping you to understand all the camera's capabilities.

### **Regarding copyrights**

Images taken using the Optio SV that are for anything other than personal enjoyment cannot be used without permission according to the rights as specified in the Copyright Act. Please take care, as there are even cases where limitations are placed on taking pictures even for personal enjoyment during demonstrations, industrial enterprise or as items for display. Images taken with the purpose of obtaining copyrights also cannot be used outside the scope of use of the copyright as laid out in the Copyright Act, and care should be taken here also.

### **To users of this camera**

- There is a possibility that recorded data may be erased or that the camera may not function correctly when used in surroundings such as installations generating strong electromagnetic radiation or magnetic fields.
- The liquid crystal panel used in the LCD display is manufactured using extremely high precision technology. Although the level of functioning pixels is 99.99% or better, you should be aware that 0.01% or fewer of the pixels may not illuminate or may illuminate when they should not. However, this has no effect on the recorded image.

### **Regarding trademarks**

- PENTAX, Optio and smc PENTAX are trademarks of PENTAX Corporation.
- The SD logo  is a trademark.
- All other brands or product names are trademarks or registered trademarks of their respective companies.

This product supports PRINT Image Matching III, PRINT Image Matching enabled digital still cameras, printers and software help photographers to produce images more faithful to their intentions. Some functions are not available on printers that are not PRINT Image Matching III compliant.

Copyright 2001 Seiko Epson Corporation. All Rights Reserved.

PRINT Image Matching is a trademark of Seiko Epson Corporation.

The PRINT Image Matching logo is a trademark of Seiko Epson Corporation.

### **Regarding PictBridge**

PictBridge allows the user to connect the printer and digital camera directly, using the unified standard for the direct printout of images. You can print images directly from the camera through a few simple operations.

- There is a possibility that the illustrations and the display screen of the LCD monitor in this manual are different from the actual product.

## FOR SAFE USE OF YOUR CAMERA

Sufficient attention has been paid to the safety of this product but please pay particular attention to the warnings indicated by the following symbols during use.



### Warning

These symbols indicate that it is possible that the user may experience serious difficulties if the warnings are not heeded.



### Caution

These symbols indicate that it is possible that the user may experience minor or middling difficulties or physical difficulties if the warnings are not heeded.

## About the Camera



### Warning

- Do not attempt to take the camera apart or remodel the camera. High voltages are present within the camera, and there is therefore a danger of electric shocks.
- If the inside of the camera should become exposed as a result of, for example, the camera being dropped, please do not under any circumstances touch such exposed portions, as there is a danger of receiving an electric shock.
- Wrapping the strap of the camera around your neck is also dangerous. Please take care that small children do not hang the strap around their necks.
- To avoid the risk of it being swallowed by mistake, keep the SD Memory Card out of the reach of small children. Seek medical attention immediately if accidentally swallowed.
- Use an AC adapter that is of the power and voltage specified for exclusive use with this product. The use of an AC adapter other than that specified exclusively for use with this product may cause fire or electric shocks.
- If the camera emits smoke or a strange smell, or in the event of any other irregularity, stop using the camera immediately, remove the battery or disconnect the AC adapter and contact your nearest PENTAX service center. Continued use of the camera may result in fire or electric shock.

## **Caution**

- Never try to disassemble or short the battery. Also, do not dispose of the battery in fire, as it may explode.
- Do not charge any batteries other than rechargeable lithium-ion battery D-LI8. The battery could explode or catch fire.
- Remove the battery from the camera immediately if it becomes hot or begins to smoke. Be careful not to burn yourself during removal.
- Some portions of the camera heat up during use, so please take care, as there is a risk of low temperature burns if such portions are held for long periods of time.
- Do not place your finger on the flash when it is discharging as there is a risk of burns.
- Do not discharge the flash while it is touching your clothing as there is a risk of discoloring.
- If any of the battery leakage should come in contact with your eyes, do not rub them. Flush your eyes with clean water and get medical attention immediately.
- If any of the battery leakage should come in contact with skin or clothes, wash the affected areas thoroughly with water.
- Should the LCD be damaged, be careful of glass fragments. Also, be careful not to allow the liquid crystal to get on your skin or eyes or in your mouth.

## About the Battery Charging Stand D-BC23 and the AC Adapter D-AC8

## **Warning**

- Do not use the product at a voltage other than the specified voltage. Use with a power source or voltage other than that designed can cause a fire or electrical shock. The specified voltage is 100-240 V AC.
- Do not disassemble or modify the product. This can cause a fire or electrical shock.
- If the generation of smoke or strange odor from the product or other abnormality occurs, immediately discontinue using and consult a PENTAX Service Center. Continuing to use the product can cause a fire or electrical shock.
- If water should happen to get inside the product, consult a PENTAX Service Center. Continuing to use the product can cause a fire or electrical shock.

- If lightning should be present during using, unplug the power cord and discontinue using. Continuing to use the product can cause damage to the equipment, fire or electrical shock.
- Wipe off the plug of the power cord if it should become covered with dust. This can cause a fire.

 **Caution**

- Do not place heavy objects on the AC plug cord, allow heavy objects to drop onto it or allow the AC plug cord to become damaged due to excessive bending. If the AC plug cord becomes damaged, consult a PENTAX Service Center.
- Do not short or touch the output terminals of the product while it is still plugged in.
- Remove the battery and unplug the AC plug cord when not using the battery charging stand.
- Do not plug in the AC plug cord with wet hands. This can cause an electrical shock.
- Do not subject the product to strong impacts or allow it to drop onto a hard surface. This can cause a malfunction.
- To reduce the risk of hazards, use only CSA/UL Certified power supply cord set, cord is Type SPT-2 or heavier, minimum NO.18 AWG copper, one end with a molded-on male attachment plug cap (with a specified NEMA configuration), and the other is provided with a molded-on female connector body (with a specified IEC nonindustrial type configuration) or the equivalent.
- Do not use the battery charging stand to charge batteries other than the ones specified. This can cause overheating or malfunctions.

## Care to be Taken During Handling

- Take the Worldwide Service Network that is included in the package. This will be useful if you experience problems abroad.
- When the camera has not been used for a long time, confirm that it is still working properly, particularly prior to taking important pictures (such as at a wedding or during travelling). Contents of the recording cannot be guaranteed if recording, playing back or transferring your data to a computer, etc. is not possible due to a malfunction of your camera or recording media (SD Memory Card), etc.
- The lens on this camera is not exchangeable. The lens is not removable.
- Do not clean the product with organic solvents such as thinner or alcohol benzene.
- Places of high temperature and humidity should be avoided. Particular care should be taken regarding vehicles, which can become very hot inside.
- Storing the camera where pesticides and chemicals are handled should be avoided. Remove from case and store in a well-ventilated place to prevent the camera from becoming moldy during storage.
- Do not use the camera where it may come in contact with rain, water or any other liquid, because the camera is not weather, water, or liquid resistant. Should the camera get wet from rain, splashing water, or any other liquid, wipe it off immediately with a dry soft cloth.
- Ensure that the camera is not subjected to substantial vibrations, shocks or pressure. Place the camera on a cushion for protection when the camera is subjected to the vibrations of a motorbike, car, or ship, etc.
- The temperature range in which the camera can be used is 0°C to 40°C (32°F to 104°F).
- The liquid crystal display will become black but will return to normal when normal temperatures are returned.
- The response speed of the liquid crystal display becomes slow at low temperatures. This is due to the properties of the liquid crystal and is not a fault.
- Periodic checks are recommended every 1 to 2 years in order to maintain high-performance.

- If the camera is subjected to rapid temperature changes, condensation may form on the inside and outside of the camera.  
Therefore put the camera in a bag or plastic bag, and take the camera out when the difference in temperature has subsided.
- Avoid contact with garbage, dirt, sand, dust, water, toxic gases, salt, etc. as this may cause damage to the camera. If rain or drops of water get onto the camera, please wipe dry.
- Refer to “Precautions When Using an SD Memory Card” (p.22) regarding the SD Memory Card.
- Please do not press forcefully on the LCD monitor. This could cause breakage or malfunction.
- Be careful not to sit down with the camera in your back pocket as this may damage the exterior of the camera or the LCD monitor.
- When using a tripod with the camera, be careful not to overtighten the screw in the tripod socket on the camera.

# Contents

FOR SAFE USE OF YOUR CAMERA .....	1
Care to be Taken During Handling .....	4
Contents .....	6
Contents of the Operating Manual .....	9
Checking the Contents of the Package .....	10
Names of Parts .....	11
Names of Operating Parts .....	12
<b>Getting Started</b> .....	<b>13</b>
<b>Attaching the Strap</b> .....	<b>13</b>
<b>Powering the Camera</b> .....	<b>14</b>
Installing the Battery .....	14
Removing the Battery .....	14
Charging the Battery .....	15
Using the AC Adapter (optional) .....	19
<b>Installing the SD Memory Card</b> .....	<b>21</b>
Image Size and Quality .....	23
<b>Initial Settings</b> .....	<b>24</b>
Setting the Display Language .....	24
Setting the Date and Time .....	25
<b>Quick Start</b> .....	<b>27</b>
<b>Taking Still Pictures</b> .....	<b>27</b>
<b>Playing Back Still Pictures</b> .....	<b>29</b>
Playing Back an Image .....	29
Playing Back the Previous or Next Image .....	29
Rotating the Displayed Image .....	30
<b>Common Operations</b> .....	<b>32</b>
<b>Turning the Camera On and Off</b> .....	<b>32</b>
Turning the Camera On in the Playback Mode .....	33
Turning the Camera On in the Voice Recording Mode .....	33
<b>Using the Button Functions</b> .....	<b>34</b>
Capture Mode .....	34
Playback Mode .....	36
Voice Recording Mode .....	37
<b>Setting the Menus</b> .....	<b>38</b>
Operation of the FULL Menu .....	38
Operation of the SIMPLE Menu .....	44
<b>Taking Pictures</b> .....	<b>48</b>
<b>Taking Pictures</b> .....	<b>48</b>
Setting the Functions (Program Mode) .....	48
Setting the Exposure Manually (Manual Exposure Mode) .....	49
Setting the Shutter Speed (Shutter-Priority Mode) .....	51
Setting the Aperture Value (Aperture-Priority Mode) .....	52
Using Preset Function Settings (User Mode) .....	54
Taking Pictures of Dark Scenes (Night-Scene Mode) .....	55



Taking Movies (Movie Mode) .....	56
Selecting the Picture Mode According to the Shooting Scene (Picture Mode) .....	58
Taking 3D Pictures (3D Image Mode) .....	60
Taking Panorama Pictures (Panorama Assist Mode) .....	66
Using the Zoom .....	68
Using the Self-Timer .....	70
Continuous Shooting (Continuous Shooting Mode) .....	71
Using the Remote Control Unit (optional) .....	72
Automatically Changing the Shooting Conditions (Auto Bracket) .....	74
Taking Pictures at Fixed Intervals (Interval Shooting) .....	76
Taking Time-lapse Movies .....	79
<b>Setting the Shooting Functions .....</b>	<b>81</b>
Changing the Mode .....	81
Selecting the Capture Mode .....	81
Displaying Shooting Information in the Capture Mode .....	82
Selecting the Flash Mode .....	84
Selecting the Focus Mode .....	85
Selecting the Recorded Pixels .....	88
Selecting the Quality Level .....	90
Adjusting the White Balance .....	92
Changing the Focusing Area .....	94
Setting the Light Metering Range to Determine the Exposure .....	95
Setting the Sensitivity .....	96
Adjusting the Focus Limit .....	97
Setting the Noise Reduction .....	98
Setting the Instant Review Time .....	99
Setting the Image Sharpness .....	100
Setting the Color Saturation .....	101
Setting the Image Contrast .....	102
Setting the Exposure (EV Compensation) .....	103
<b>Saving the Settings .....</b>	<b>104</b>
Saving the Menu Items (Memory) .....	104
Registering Functions in the User Mode .....	106
<b>Recording and Playback .....</b>	<b>108</b>
<hr/>	
<b>Recording Sound (Voice Recording Mode) .....</b>	<b>108</b>
<b>Playing Back Sounds .....</b>	<b>109</b>
<b>Adding a Voice Memo .....</b>	<b>110</b>
<b>Playback/Deleting/Editing .....</b>	<b>111</b>
<hr/>	
<b>Playing Back Images .....</b>	<b>111</b>
Playing Back Still Pictures .....	111
Zoom Display .....	111
Playing Back Movies .....	113
Displaying Shooting Information in the Playback Mode .....	114
Nine Image Display .....	115
Slideshow .....	116
<b>Deleting Images, Movies and Sounds .....</b>	<b>118</b>
Deleting a Single Image or Sound .....	118

Deleting Selected Images .....	120
Deleting All Images .....	121
Protecting Images and Sounds from Deletion (Protect) .....	122
<b>Viewing Images on a TV .....</b>	<b>124</b>
<b>Setting the Printing Service (DPOF) .....</b>	<b>125</b>
Printing Single Images .....	125
Printing All Images .....	127
<b>Direct Printing Using PictBridge .....</b>	<b>129</b>
Connecting the Camera to the Printer .....	129
Printing Single Images .....	130
Printing All Images .....	131
Printing Using the DPOF Settings .....	132
Disconnecting the Camera from the Printer .....	133
<b>Editing Images .....</b>	<b>134</b>
Changing the Image Size and Quality .....	134
Trimming Images .....	136
Using Digital Filters to Edit Images .....	138

## Settings

**142**

---

<b>Camera Settings .....</b>	<b>142</b>
Formatting an SD Memory Card .....	142
Adjusting the Brightness of the LCD Monitor .....	143
Changing the Start-up Screen, Background Color and Screen Effects .....	144
Changing the Date and Time .....	147
Changing the Sound Settings .....	148
Setting the World Time .....	150
Changing the Display Language .....	152
Setting the Folder Name .....	152
Changing the Video Output Format .....	153
Changing the USB Connection Mode .....	153
Sleep Timeout .....	154
Setting Auto Power Off .....	155
Registering a Function (Fn Setting) .....	156
Resetting to Default Settings .....	159

## Appendix

**160**

---

<b>List of Cities .....</b>	<b>160</b>
<b>Optional Accessories .....</b>	<b>161</b>
<b>Messages .....</b>	<b>162</b>
<b>Troubleshooting .....</b>	<b>164</b>
<b>Main Specifications .....</b>	<b>166</b>
<b>WARRANTY POLICY .....</b>	<b>169</b>
<b>Index .....</b>	<b>173</b>

# Contents of the Operating Manual

This operating manual contains the following chapters.

## 1 Getting Started

This chapter explains what you need to do after purchasing the camera before you start taking pictures. Be sure to read it and follow the instructions.

## 2 Quick Start

This chapter explains the simplest way to take pictures and play back images. Use it if you want to start taking pictures straightaway.

## 3 Common Operations

This chapter explains common operations such as the functions of the buttons and how to use the menus. For more details, refer to the respective "Taking Pictures", "Recording and Playback", "Playback/Deleting/Editing" and "Settings" chapters.

## 4 Taking Pictures

This chapter explains the various way of capturing images and how to set the relevant functions, including how to use the Capture Mode screen to select the capture mode best suited to the situation.

## 5 Recording and Playback

This chapter explains how to record sound only or add a voice memo to an image, and how to play back voice memos.

## 6 Playback/Deleting/Editing

This chapter explains how to play back images on the camera or on a TV, how to delete, resize and trim images, and how to print images directly to the printer.



## 7 Settings

This chapter explains how to set the camera-related functions.

## 8 Appendix

This tells you about the messages displayed on the LCD monitor and what to do in the event of trouble.

The meanings of the symbols used in this operating manual are explained below.

	indicates the reference page number for an explanation of the related operation.
	indicates information that is useful to know.
	indicates precautions to be taken when operating the camera.

1

2

3

4

5

6

7

8

## Checking the Contents of the Package



Camera  
Optio SV

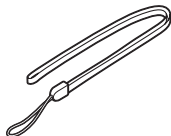

Strap  
O-ST20 (\*)

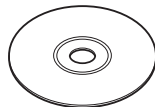

Software (CD-ROM)  
S-SW23

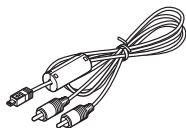

AV cable  
I-AVC7 (\*)

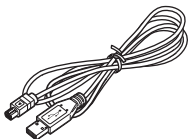

USB cable  
I-USB17 (\*)



Rechargeable  
lithium-ion battery  
D-LI8 (\*)

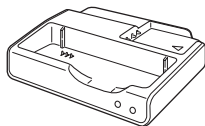

Battery charging stand  
D-BC23 (\*)



AC plug cord  
D-CO2 (\*)



32 MB SD Memory Card

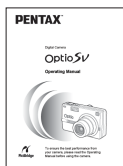

Operating Manual  
(this manual)



Operating Manual  
(PC Connection Manual)

Items marked with an asterisk (\*) are also available as optional accessories. For other optional accessories, refer to "Optional Accessories" (p.161).

# Names of Parts

## Front

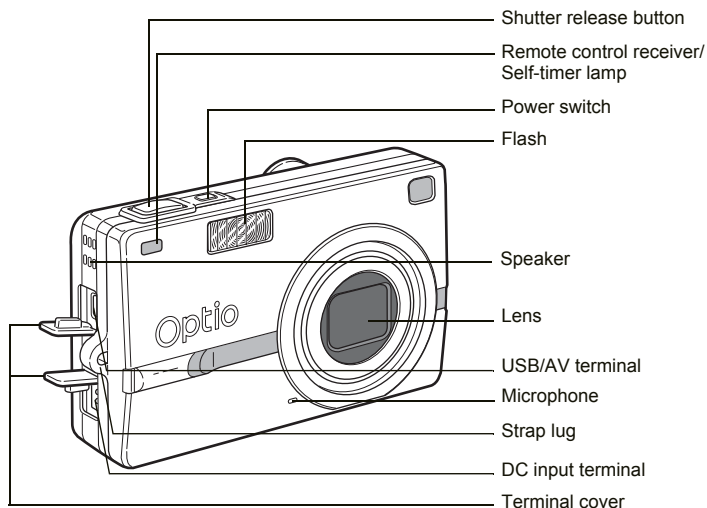

## Back

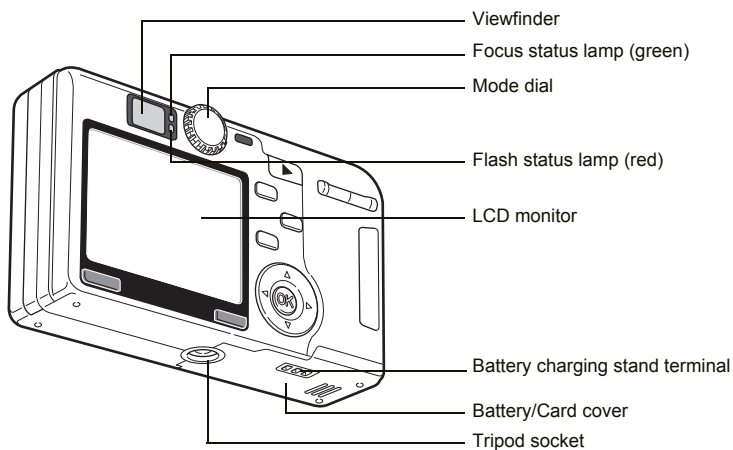

## Names of Operating Parts

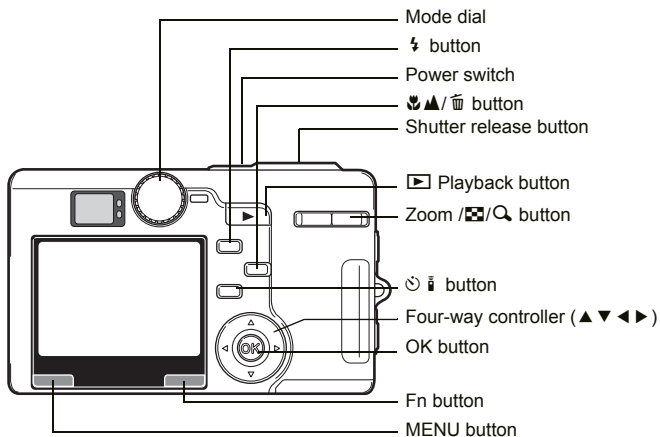

### Guide Indications

A guide to available button operations appears on the LCD monitor during operation.

The buttons are indicated as shown below.

Four-way controller (▲)	▲
Four-way controller (▼)	▼
Four-way controller (◀)	◀
Four-way controller (▶)	▶
MENU button	<b>MENU</b>

Shutter release button	<b>SHUTTER</b>
Zoom / 📷/🔍 button	🔍
🗑️ button	🗑️
OK button	<b>OK</b>
Fn button	<b>Fn</b>

## Attaching the Strap

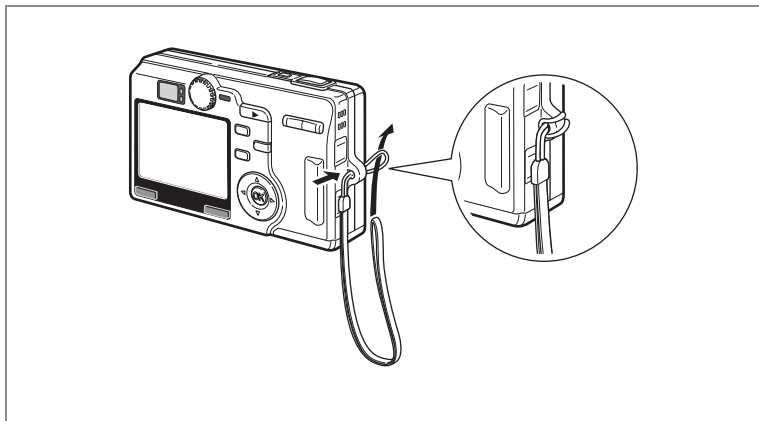

Pass the narrow end of the strap through the strap lug and pass the other end through the loop.

# Powering the Camera

1

Getting Started

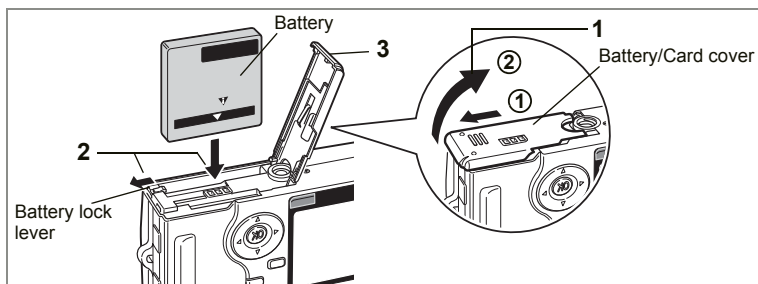

## Installing the Battery

Install the battery provided with the camera.

### 1 Open the battery/card cover.

Slide the battery/card cover in the direction indicated by the arrow ① and flip the cover open ②.

### 2 Insert the battery with the ▲ symbol facing toward the LCD monitor while using the side of the battery to press the battery lock lever in the direction indicated by the arrow.

### 3 Close the battery/card cover.

## Removing the Battery

### 1 Release the battery by using your finger to press the battery lock lever in the same direction as when you inserted the battery.

Pull the battery out.



If you intend to use the camera continuously for a long period, use of the AC adapter D-AC8 (optional) is recommended. (p.19)



- Insert the battery correctly. If the battery is incorrectly oriented, it may cause malfunction.
- Do not remove the battery when the camera is turned on.
- If you do not intend to use the camera for an extended period of time, remove the battery.
- If the camera is left without the battery for a long time, the date will be reset.



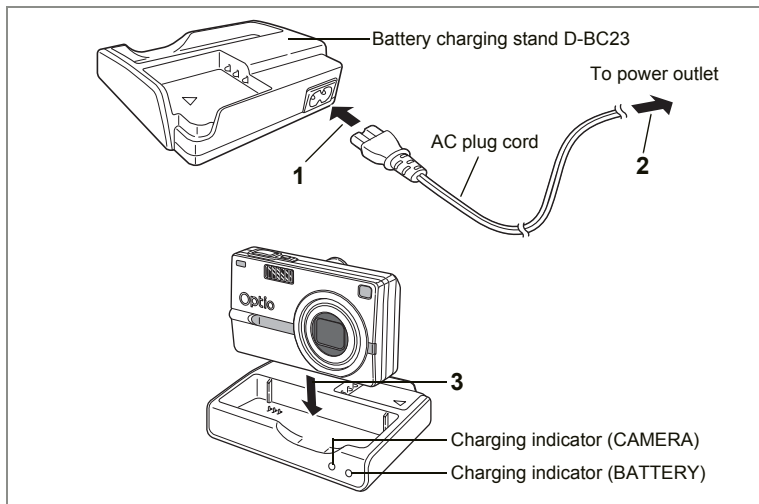

## Charging the Battery

Use the supplied D-BC23 battery charging stand to charge the battery before using the camera for the first time or when the [Battery depleted] message appears. You can charge the battery without removing it from the camera.

- 1 Connect the AC plug cord to the battery charging stand D-BC23.**
- 2 Plug the AC plug cord into the power outlet.**

### Charging the Battery in the Camera

- 3 Place the camera in the charger.**

Turn the camera off and position the camera so that the lens rests in the depression in the case. When charging the battery, the charging indicator of the battery charging stand indicates the following information.

Battery is charging	Lit
Battery is charged	Off
Battery error	Blinks

- 4 Remove the camera from the battery charging stand when charging is completed.**

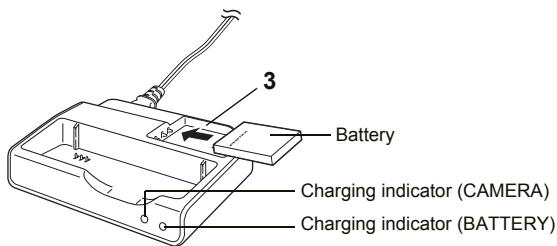

### Charging the Battery by Itself

You can remove the battery from the camera and charge it.

#### 3 Place the battery in the charger so that the PENTAX name is visible.

The charging indicator (BATTERY) lights red while the battery is charging and turns off when charging is completed.

#### 4 Remove the battery from the battery charging stand when charging is completed.



- The time required for full charge is about 100 minutes. The appropriate ambient temperature range for charging the battery is 0°C – 40°C (32°F to 104°F).
- The charging time may vary depending on the ambient temperature and charging conditions.
- When the battery reaches the end of its service life, the time that the camera can be operated becomes shorter even when the battery is fully charged. In this event, replace the battery.
- When charging the battery in the camera, another battery can be placed in the charger at the same time. This is useful when you have spare battery. When the camera and battery is placed in the charger, the charging indicator (CAMERA) and charging indicator (BATTERY) light red. When the battery inserted in the camera is fully charged, the charging of the spare battery starts automatically. When the charging of the spare battery starts, the charging indicator (CAMERA) turns off and the charging indicator (BATTERY) lights red.
- You can also remove the battery from the camera and charge it using the optional D-BC8 battery charger.



- Always charge the battery before using the camera for the first time or when the battery has not been used for an extended period of time.
- Do not use the D-BC23 battery charging stand to charge batteries other than D-LI8 rechargeable lithium-ion batteries, as the charger may overheat or be damaged as a result.
- If the battery is inserted correctly but the charging indicator fails to blink, the battery may be faulty. Replace with a new battery.

• **Approximate Operating Time (when the D-LI8 battery is fully charged)**

Number of recordable images: Approx. 100 (at 23°C with the LCD monitor on and the flash used for 50% of shots, based on the CIPA standard.)

Playback time: Approx. 130 min.  
(based on PENTAX measuring conditions.)

- The above figures may vary according to the conditions in which the camera is used.



- In general, battery performance temporarily deteriorates as the temperature decreases. When using the camera in a cold environment, keep it warm by putting it in your pocket or inside your coat. Battery performance that has deteriorated due to low temperature will be restored when the battery is returned to room temperature.
- Be sure to take a spare battery with you when traveling abroad or to a cold region, or if you intend to take a lot of pictures.

• **Battery Level Indicator**

You can check the battery level by the symbol on the LCD monitor.

	(lit green)	: Adequate power remains.
↓		
	(lit yellow)	: Battery is running very low.
↓		
	(lit red)	: Battery is exhausted.
↓		
[Battery depleted]		: The camera will turn off after the message appears.

## • Recycling Batteries



This symbol indicates that the battery is recyclable. Cover the terminals with insulating tape and take the battery to a store displaying this symbol.

**Li-ion**

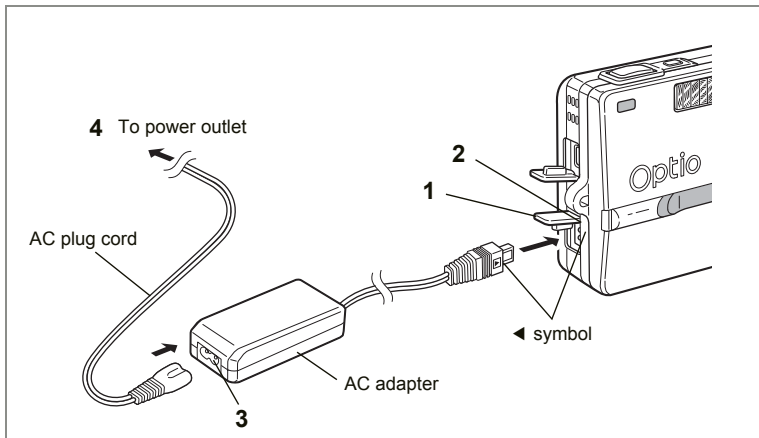

## Using the AC Adapter (optional)

If you intend to use the LCD monitor for a long time or connect the camera to a PC, use of the AC adapter D-AC8 is recommended.

- 1** Make sure that the camera is turned off and open the terminal cover.
- 2** Connect the DC terminal on the AC adapter to the DC input terminal on the camera, being sure to match the ◀ symbols.
- 3** Connect the AC plug cord to the AC adapter.
- 4** Plug the AC plug cord into the power outlet.



- Make sure that the camera is turned off when connecting or disconnecting the AC adapter.
- Make sure that the AC plug cord and connecting cable are inserted securely. The data may be lost if the cable becomes disconnected while you are taking pictures.
- Be sure to read the operation manual accompanying the AC adapter before using the adapter.
- Be sure to match the ◀ symbols when connecting the DC terminals. Inserting the plugs with too much force may damage them.

## Precautions When Using the Battery Charging Stand or AC Adapter

To avoid the risk of fire or electric shock when using the battery charging stand or AC adapter, be sure to read the section on “FOR SAFE USE OF YOUR CAMERA” on page 1. Refer to page 166 for the specifications of the battery charging stand and AC adapter.

# Installing the SD Memory Card

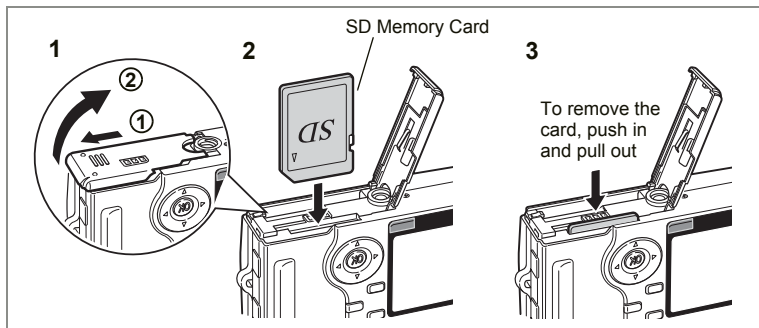

An SD Memory Card can be used with this camera. Captured images and recorded sounds are recorded on the SD Memory Card.



- Make sure that the camera is turned off before inserting or removing the SD Memory Card.
- Do not use a new SD memory card or one used with another camera without formatting it with your camera before use. Refer to "Formatting an SD Memory Card" (p.142) for instructions on formatting.

## 1 Open the battery/card cover.

Slide the battery/card cover in the direction indicated by the arrow ① and flip the cover open ②.

## 2 Insert an SD Memory Card so the label (the side with the ▲ symbol) is facing toward the LCD monitor and push the card in until it clicks.

## 3 Close the battery/card cover.

To remove the card, eject the card by pressing it in the direction indicated by the arrow and pull it out.



The number of recordable images varies depending on the capacity of the SD Memory Card or built-in memory and the selected image size and quality. (p.23)

## Precautions When Using an SD Memory Card

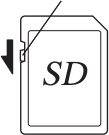
- Make sure that the camera is turned off before opening the battery/card cover.
  - The SD Memory Card is equipped with a write-protect switch. Setting the switch to [LOCK] protects the existing data by prohibiting recording of new data, deletion of existing data or formatting of the card. Write-protect switch
- 
- Care should be taken if you remove the SD Memory Card immediately after using the camera, as the card may be hot.
  - Do not remove the SD Memory Card or turn the camera off while data is being recorded on the card, images or sound are being played back, or the camera is connected to a PC with the USB cable as this may cause the data to be lost or the card to be damaged.
  - Do not bend the SD Memory Card or subject it to violent impact. Keep it away from water and store away from high temperature.
  - Be sure to format unused cards or cards that have been used on another camera. Refer to "Formatting an SD Memory Card" (p.142) for instructions on formatting.
  - Do not remove the SD Memory Card during formatting as this may damage the card and render it unusable.
  - The data on the SD Memory Card may be deleted in the following circumstances. PENTAX does not accept any liability for data that is deleted
    - (1) when the SD Memory Card is mishandled by the user.
    - (2) when the SD Memory Card is exposed to static electricity or electrical interference.
    - (3) when the card has not been used for an extended period of time.
    - (4) when the card is ejected, the AC adapter is disconnected or the battery is removed while the data on the card is being recorded or accessed.
  - The SD Memory Card has a limited service life. If it is not used for an extended period of time, the data on the card may become unreadable. Be sure to make a backup of important data on a PC.
  - Avoid using or storing the card where it may be exposed to static electricity or electrical interference.
  - Avoid using or storing the card in direct sunlight or where it may be exposed to rapid changes in temperature or to condensation.
  - When using an SD Memory Card with a slow recording speed, recording may stop while you are taking movies even when there is adequate space in the memory, or shooting and playback may take a long time.
  - When you purchase the SD Memory Cards, access the PENTAX website and confirm beforehand if they have compatibility with your camera. Inquiries on the card compatibility can also be answered by your nearest PENTAX service center.



## Image Size and Quality

Choose the image size and quality best suited to your purpose. Higher quality levels and numbers of recorded pixels produce clearer images for printing, but the resulting increase in data volume reduces the total number of pictures that can be taken.

Choose the appropriate number of recorded pixels and quality level on the [  Rec. Mode ] menu.

Setting the Menus  p.38

Selecting the Recorded Pixels  p.88

Selecting the Quality Level  p.90

### ● Appropriate Sizes According to Use

Size	Appropriate Use	
2560×1920	Sharp, Clear ↑	Fine printing such as photo printing, large-sized printing, editing
2048×1536		
1600×1200		Postcard-sized printing, using on homepage, attaching to E-mail
1024×768		
640×480		

The default setting is 2560×1920.

### ● Appropriate Quality According to Use

★★★	Best	Lowest compression ratio. Suitable for large A4-size photo prints.
★★	Better	Standard compression ratio. Suitable for photo prints or viewing images on a computer screen.
★	Good	Highest compression ratio. Suitable for attaching to e-mails or creating websites.

The default setting is ★★.

### ● Approximate Number of Recordable Images by Size and Quality

Quality Level Recorded Pixels	Best ★★★	Better ★★	Good ★	Movie (320×240)
2560×1920	Approx. 42	Approx. 66	Approx. 93	Approx. 158 sec.
2048×1536	Approx. 61	Approx. 95	Approx. 132	
1600×1200	Approx. 81	Approx. 127	Approx. 174	
1024×768	Approx. 132	Approx. 202	Approx. 274	
640×480	Approx. 192	Approx. 295	Approx. 349	

- The above table indicates the number of images when using the SD Memory Card (64MB).
- The above table is based on standard shooting conditions specified by PENTAX and may vary depending on the subject, shooting conditions, capture mode, SD Memory Card, etc.

# Initial Settings

1

Getting Started

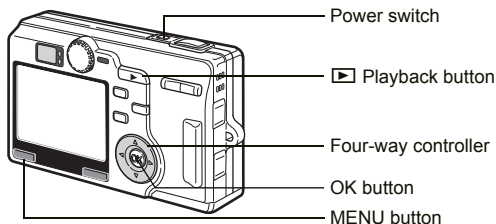

If the Initial Settings screen or Date Adjust screen appears when you turn the camera on, follow the procedure below to set the display language and/or current date and time.

If the Initial Settings screen appears:

☞ p.24, 25 “Setting the Display Language”, “Setting the Date and Time”

If the Date Adjust screen appears:

☞ p.25 “Setting the Date and Time”

If neither screen appears, setting is not required.

## Setting the Display Language

You can choose the language in which the menus, error messages, etc. are displayed from the following: English, French, German, Spanish, Italian, Russian, Korean, Chinese (traditional and simplified) and Japanese.

**1 Press the four-way controller (▲▼) to select [Language/言語].**

The default setting is English.

**2 Press the four-way controller (▶).**

The Language Setting screen appears.

**3 Press the four-way controller (▲▼) to select the language.**

**4 Press the OK button.**

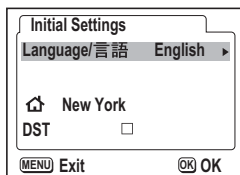

## Setting the Date and Time

Set the current date and time and the display style.

### 1 Press the four-way controller (▶).

▲ and ▼ appear above and below “mm/dd/yy”.

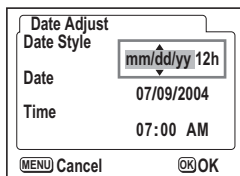

### 2 Press the four-way controller (▲ ▼) to select the date style.

### 3 Press the four-way controller (▶).

▲ and ▼ appear above and below “12h”.

### 4 Press the four-way controller (▲ ▼) to select [24h] (24-hour display) or [12h] (12-hour display).

### 5 Press the four-way controller (▶).

### 6 Press the four-way controller (▲ ▼) to select [Date].

### 7 Press the four-way controller (▶).

▲ and ▼ appear above and below the month.

### 8 Press the four-way controller (▲ ▼) to change the month.

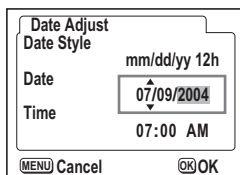

### 9 Repeat Step 7 and 8 to change the date and year.

### 10 Press the four-way controller (▶).

### 11 Press the four-way controller (▲ ▼) to select [Time].

### 12 Press the four-way controller (▶).

▲ and ▼ appear above and below the hour.

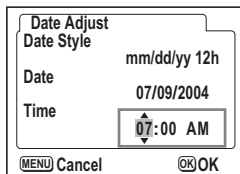

**13 Press the four-way controller (▲▼) to change the hour.**

AM/PM switches automatically as you change the hour if you selected [12h] in Step 3.

**14 Repeat Step 12 and 13 to change the minute.****15 Press the OK button when you have finished the settings.**

The camera is ready to take pictures. If you set the date and time using the MENU button, you will return to the menu screen. Press the MENU button.



- When you finish the settings and press the OK button, the camera clock is reset to 00 seconds.
- To set the exact time, press the OK button when the time signal (on the TV, radio, etc.) reaches 00 seconds.



- When the Initial Settings screen is displayed, you can cancel the setting operation and switch to the Capture mode by pressing the MENU button. In this case, the screen will appear next time you turn the camera on.
- You can change the settings after they have been made. Refer to "Changing the Date and Time" (p.147).

## Taking Still Pictures

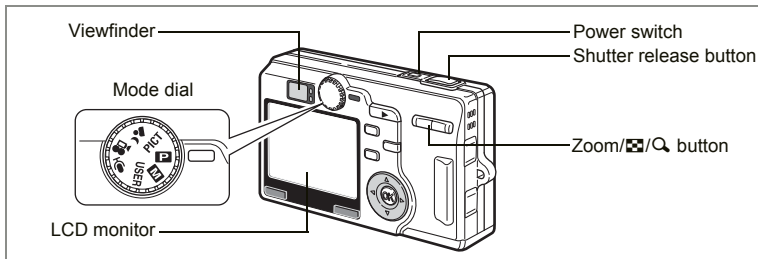

The simplest procedure for taking still pictures is described below. The flash fires automatically depending on the light conditions.

- 1 Press the power switch.**
- 2 Set the mode dial to **P**.**
- 3 Confirm the subject and shooting information on the LCD monitor.**

The focus frame in the middle of the LCD monitor indicates the zone of automatic focusing. You can change the size of the subject by pressing the Zoom/□/Q button.

⬆ : makes the subject bigger.

⬆⬆ : makes the subject smaller.

You can check the size of the subject by looking through the viewfinder.



Focus frame



As there is no focus frame in the viewfinder, be sure to check the focusing area on the LCD monitor.

- 4 Press the shutter release button halfway.**  
The focus frame on the LCD monitor will light green when the camera is in focus.
- 5 Press the shutter release button.**  
The image appears on the LCD monitor for one second (Instant Review) and is recorded on the SD Memory Card or in the built-in memory. (The green and red lamps on the right of the viewfinder blink alternately while the image is being recorded.)

## Using the Shutter Release Button

The shutter release button works in a two-step action as follows.

### Press halfway

The focus and exposure are locked when the shutter release button is pressed lightly (halfway). The following information is indicated on the LCD monitor and by the focus status and flash status lamps when the shutter release button is pressed halfway.

#### 1. Focus frame

The focus frame turns green if the subject is in focus. The frame does not appear if the subject is out of focus.

#### 2. Status lamps

	Focus status lamp (green)	Flash status lamp (red)
Lit	Subject is in focus	Flash is charged
Blinks	Subject is out of focus	Flash is charging

Pictures cannot be taken while the flash is charging.

### Press down fully

Press the shutter release button all the way down (fully) to take a picture.

[Poor focusing conditions]

The camera may not be able to focus under the following conditions. In this case, lock the focus on an object the same distance away as the subject (by pressing the shutter release button halfway) and aim the camera at your subject with the shutter release button kept pressed halfway and press the shutter release button fully.

- Objects that lack contrast such as a blue sky or white wall
- Dark places or objects, or conditions that prevent light being reflected back
- Finely patterned object
- Fast moving objects
- When there is an object in the foreground and an object in the background in the same picture
- Strongly reflected light or strong backlighting (bright background)

## Instant Review

The Instant Review default setting is one second. During this time, you can delete the image by pressing the  button, selecting [Delete] when the [Delete] menu appears and pressing the OK button. (p.118)

You can also record a voice memo by pressing the OK button during Instant Review.

Setting the Instant Review Time p.99

## Playing Back Still Pictures

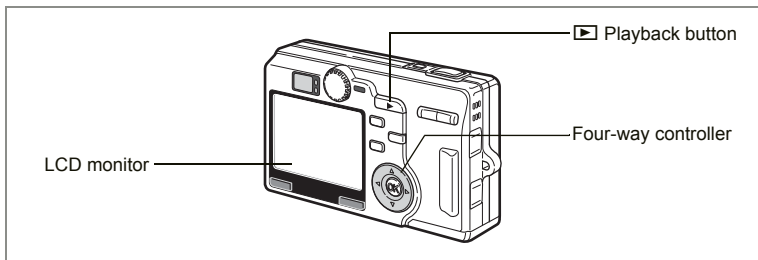

### Playing Back an Image

You can display the still picture you have just taken.

- 1 **Press the  Playback button after taking a picture.**



The image appears on the LCD monitor.



Zoom Display  p.111

### Playing Back the Previous or Next Image

Still pictures can be played back one at a time, proceeding either forward or backward.

- 1 **Press the  Playback button after taking a picture.**  
The image appears on the LCD monitor.
- 2 **Press the four-way controller ( .**



displays the previous image.



displays the next image.

## Rotating the Displayed Image

### 1 Press the Playback button after taking a picture.

The image appears on the LCD monitor.



### 2 Press the four-way controller ()

The image is rotated 90° clockwise each time the button is pressed.





- An image which is rotated cannot be magnified.
- When you switch to the Capture mode or menu while the image is rotated, the rotation information of the image is saved.
- The image captured with other camera or created with computer cannot be rotated.

## Deleting the Displayed Image

You can delete the image displayed on the LCD monitor by pressing the  button, using the four-way controller () to select [Delete] and pressing the OK button.

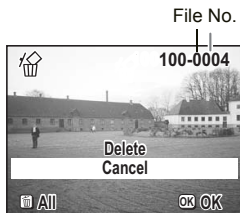
Press the shutter release button halfway or turn the mode dial to return to the Capture mode.



- The last picture taken appears on the LCD monitor when you switch to the Playback mode.
- You can enlarge the image displayed on the LCD monitor by pressing the Zoom /  button. (The image cannot be magnified when rotated.)
- If there are no images stored, the [No image or sound] message appears.

Deleting Images, Movies and Sounds  p.118



**Memo**

2

**Quick Start**

## Turning the Camera On and Off

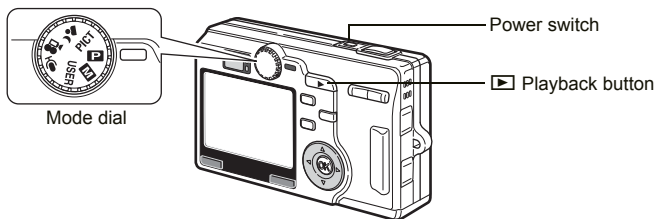

3

## 1 Press the power switch.

The lens extends and the camera turns on in the Capture mode. The camera is ready to take pictures by pressing the shutter release button.

- Press the Playback button to switch to the Playback mode and view pictures while the lens is extended.
- Hold down the Playback button for more than two seconds to activate the Playback mode with the lens unextended.

## 2 Press the power switch again.

The camera turns off.

Switching between the Capture Mode and Playback Mode  p.81
--

Taking Pictures  p.48
-----------------------

## Turning the Camera On in the Playback Mode

Use the Playback mode with the lens unextended when you want to play back pictures one after another.

### 1 Press the power switch while pressing the Playback button.



The camera turns on in the Playback mode with the lens unextended.

Perform the following operations to switch between the Playback mode with the lens unextended and the Capture mode.

**Playback mode with the lens unextended** ⇄ **Capture mode**

- Press the  Playback button or shutter release button.
- Turn the mode dial.

**Capture mode** ⇄ **Playback mode with the lens unextended**

- Hold down the  Playback button for more than two seconds.
- Press the  Playback button. (for Voice Recording mode).

Playing Back Still Pictures  p.29

## Turning the Camera On in the Voice Recording Mode

The Voice Recording mode is for recording sound only. The lens does not extend in this mode.

You can use the camera as a voice recorder.

### 1 Set the mode dial to and press the power switch.

The camera turns on in the Voice Recording mode. The lens does not extend.



When the mode dial is turned in the Voice Recording mode, the lens extends and the camera switches to capture status.

Recording Sound  p.108

# Using the Button Functions

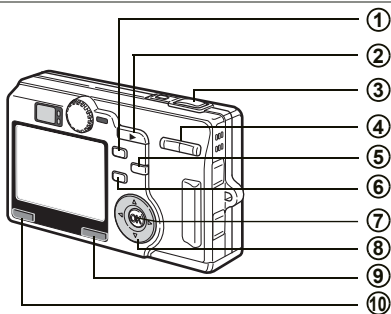

## Capture Mode

- ① **⚡ button**  
Changes the flash mode. (☞p.84)
- ② **▶ Playback button**  
Switches to the Playback mode. When pressed again, returns to the Capture mode. (☞p.29)
- ③ **Shutter release button**  
Press halfway: Adjusts and locks the AF and AE.  
Changes to the Capture mode after selecting a menu item.  
Press down fully: Takes picture.  
Starts and ends shooting movie.  
Changes to the Capture mode after selecting a menu item.
- ④ **Zoom button**  
Changes the size of the subject. (☞p.27)
- ⑤ **👁️▲ button**  
Changes the focus mode as follows  
Macro mode (☞p.85)  
Infinity-Landscape mode (☞p.85)  
Focusing Area mode (☞p.87)  
Super Macro mode (☞p.85)  
Manual Focus mode (☞p.86)

- ⑥  **button**  
Changes the drive mode as follows
- |                                |                            |
|--------------------------------|----------------------------|
| Self-timer Shooting (p.70)     | Continuous Shooting (p.71) |
| Auto Bracket Shooting (p.74)   | Interval Shooting (p.76)   |
| Remote Control Shooting (p.72) |                            |
- ⑦ **OK button**  
Changes the information displayed on the LCD monitor. (p.114)  
Sets the menu item.
- ⑧ **Four-way controller (◀▶)**  
Sets the exposure.
- ⑨ **Fn button**  
Displays the Fn Setting screen.
- ⑩ **MENU button**  
Displays the [📷 Rec.Mode], [▶ Playback] and [⚙️ Set-up] menus.  
(p.38)

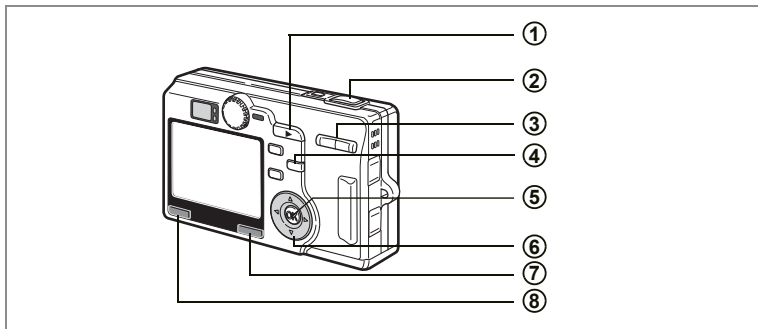

## Playback Mode

- ① **▶ Playback button**  
Switches to the Capture mode.
- ② **Shutter release button**  
Press halfway: Changes to the Capture mode and adjusts and locks the AF and AE.  
Press down fully: Changes to the Capture mode and takes picture.  
Changes to the Capture mode and Starts and ends shooting movie.
- ③ **Zoom//Q button**  
Press during normal playback to display nine images at once. (☞p.115)  
Press Zoom//Q button during zoom playback to change the size of the Zoom Display image displayed on the LCD monitor. (☞p.111)
- ④  **button**  
Deletes the image displayed on the LCD monitor. (☞p.118)
- ⑤ **OK button**  
Changes the information displayed on the monitor as follows. (☞p.82)  
Still picture, Movie: Display On, Histogram Display, Display Off  
Sound: Display On, Display Off
- ⑥ **Four-way controller**  
(▲) Replays the movie and voice memo. (☞p.109, 113)  
(◀▶) Displays the previous or next image. (☞p.29)  
(▼) Rotates the image. (☞p.30)  
Stops playback of the movie.
- ⑦ **Fn button**  
Displays the Fn Setting screen.
- ⑧ **MENU button**  
Displays the [ Rec.Mode], [ Playback] and [ Set-up] menus. (☞p.38)

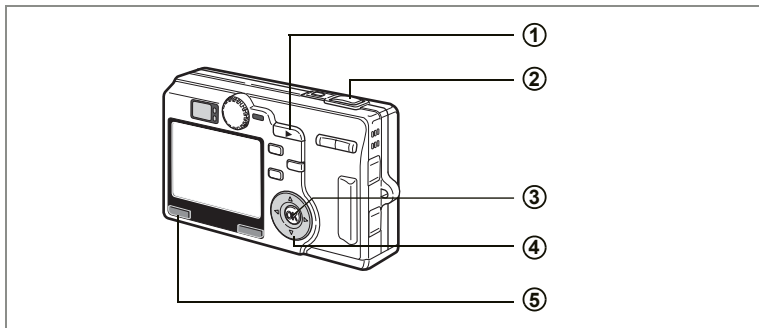

## Voice Recording Mode

- ① **▶ Playback button**  
Switches to the Playback mode with the lens unextended. (p.36) When pressed again, returns to the Voice Recording mode.
- ② **Shutter release button**  
When pressed, starts recording, and when pressed again, stops recording. When pressed for more than one second, recording continues for as long as the button is held down and stops when the button is released.
- ③ **OK button**  
Changes the information displayed on the monitor as follows.  
Display On, Display Off
- ④ **Four-way controller (in the Playback mode with the lens unextended)**  
(▲) Starts playback. When pressed again, pauses playback.  
(◀▶) Performs the following operations during playback. Selects a recorded file before playback.  
When (◀) is pressed during playback, rewinds five seconds.  
When (▶) is pressed during playback, advances five seconds.
- ⑤ **MENU button**  
When pressed during standby or before recording or playing back, displays the [▶ Playback] and [⚙️ Set-up] menus. (p.38)

# Setting the Menus

When you press the MENU button, the menus are displayed on the LCD monitor. You can set functions, save the settings, and change the camera settings on these menus.

This camera has two types of menus: SIMPLE menu, which can set commonly used functions, and FULL menu, which can set all functions.

## Operation of the FULL Menu

When you are making settings from a menu, a guide to button operations appears on the LCD monitor.

### 1 Press the MENU button.

The [📷 Rec.Mode] menu appears when you display the menu in the Capture mode, and the [▶ Playback] menu appears when you display the menu in the Playback mode.

The selected area appears in a frame.

### 2 Press the four-way controller (◀▶).

Changes the menu screen.

### 3 Use the four-way controller (▲▼) to choose an item.

Moves the frame up or down.

### 4 Change the setting of the selected item.

There are three ways to change the settings.

#### ① Press the four-way controller (▶) to display the settings and change them. (Pop up menu)

Press the OK button to return to the menu when you have finished changing the settings.

#### ② Press the four-way controller (▶) to move to another select screen and change the settings.

Press the OK button to return to the menu when you have finished changing the settings.

#### ③ Press the four-way controller (◀▶) and change the settings.

### 5 Press the MENU button.

The settings are saved and the camera switches to capture or play back status.



# 1 MENU button

[CAMERA] [Rec.Mode] Menu

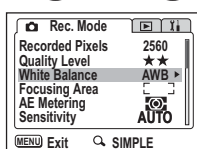
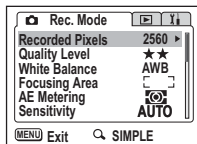
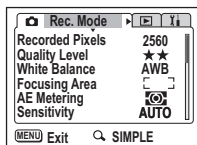

To the next screen

# 2

[PLAYBACK] [Playback] Menu

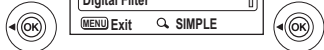
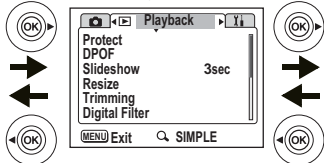

[SETUP] [Set-up] Menu

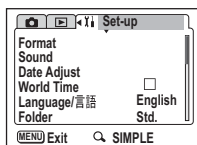

## 4① Pop Up Menu

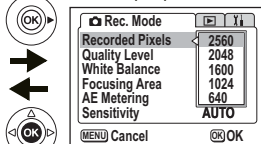

## 4② Select Screen

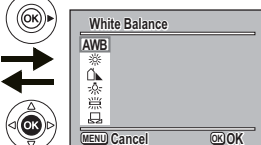

## 4③

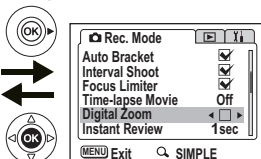



If you perform the following without pressing the OK button in Step 4, the settings are saved and the camera switches to capture or play back status.

Switch to capture status	Press the shutter release button half way. Press the shutter release button fully. Turn the mode dial.
Switch to playback status	Press the playback button.
Switch to capture or playback status	Press the <b>Fn</b> button,  button,  button, or   button after finishing the setting.

3



- If you press the MENU button to exit the select screen ① or ②, any changes you have made to the settings will not be saved.
- Even after pressing the OK button to exit the menu, if you turn the camera off incorrectly (such as by removing the battery while the camera is turned on), any changes you have made to the settings will not be saved.
- The menu is exited automatically approximately one minute after the last operation.

## FULL Menu List

### [📷 Rec.Mode] Menu

Item	Description	Default Setting	Page
Recorded Pixels	For selecting the number of pixels	2560 × 1920	p.88
Quality Level	For selecting the image compression ratio	★★	p.90
White Balance	For adjusting the color balance according to lighting	AWB (Auto)	p.92
Focusing Area	For changing the area of the autofocus	[ (Multiple)]	p.94
AE Metering	For setting the metering method to determine the exposure	 (Multi-segment)	p.95
Sensitivity	For setting the sensitivity	Auto	p.96
Auto Bracket	For setting the shooting conditions such as exposure, saturation and sharpness	Exposure (±0.3)	p.74
Interval Shoot	For taking pictures in specified interval of time	—	p.76
Focus Limiter	For switching between limiting and not limiting lens movement during normal shooting and macro shooting	On	p.97
Time-lapse Movie	For setting the frame rate when recording movies	Off	p.79
Digital Zoom	For taking digital zoom pictures	On	p.68
Instant Review	For setting the Instant Review time	1 sec.	p.99
3D Mode	For taking 3D pictures	⇕ (Parallel mode)	p.60
Memory	For saving the shooting function settings when the camera is turned off	—	p.104
<b>M</b>	For setting the capture modes to register for the Manual Exposure mode	M	p.49
USER	For setting the functions registered in the USER mode	P	p.54
Noise Reduction	For reducing noise	On	p.98
Sharpness	For setting the sharpness	Normal	p.100
Saturation	For setting the saturation	Normal	p.101
Contrast	For setting the contrast	Normal	p.102

## [▶ Playback] Menu

Item	Description	Page
Protect	For protecting images and sounds from deletion	p.122
DPOF	For setting the printing service to print out images	p.125
Slideshow	For playing recorded images successively	p.116
Resize	For changing the size of images	p.134
Trimming	For trimming images	p.136
Digital Filter	For creating a filter effect using color filters (red, blue, green, etc.)	p.138
Quick Zoom	For playing back images at the maximum zoom size by pressing the Zoom/⏏/Q button only once	p.112
Quick Delete	For displaying the Delete screen with [Delete] highlighted when ON is selected	p.119

## [ⓘ Set-up] Menu

Item	Description	Page
Format	For formatting the SD Memory Card	p.142
Sound	For adjusting the operation volume and playback volume and setting the type of start-up sound, shutter sound, key operation sound, self-timer sound, etc.	p.148
Date Adjust	For adjusting the date and time	p.147
World Time	For setting the world time	p.150
Language/言語	For changing the language in which menus and messages appear	p.152
Folder setting	For changing the name of the folder to save the images and sounds	p.152
Screen Setting	For setting the start-up screen, background screen and screen effects	p.144
Brightness Level	For changing the brightness of the LCD monitor	p.143
Video Out	For setting the video output format	p.153
USB Connection Mode	For changing the USB connection mode	p.153
Sleep Timeout	For setting the power saving function	p.154
Auto Power Off	For turning off the power automatically	p.155
Fn Setting	For registering a function on the four-way controller (▲▼◀▶)	p.156
Reset	For returning the camera settings to defaults	p.159

## Memo

## Operation of the SIMPLE Menu

The SIMPLE menu displays only commonly used menus. The same menu will be displayed in both Capture mode and Playback mode.

### 1 Press the MENU button.

FULL menu appears. In the Capture mode, the [📷 Rec.Mode] menu appears and in the Playback mode, the [▶ Playback] menu appears. The selected area appears in a blue frame.

### 2 Press $\uparrow$ /Q on the Zoom/📐/Q button.

The SIMPLE menu appears.

### 3 Press the four-way controller (▲▼) to choose an item.

Moves the frame up or down.

### 4 Change the setting of the selected item.

There are two ways to change the setting.

- ① Press the four-way controller (▶) to display the settings and change the setting. (Pop up menu)
- ② Press the four-way controller (▶) to move to another select screen and change the setting.

Press the OK button to return to the menu when you have finished the settings.

### 5 Press the MENU button.

The settings are saved and the camera switches to capture or play back status.

## Return to FULL Menu

### 1 Press $\uparrow$ /Q on the Zoom/📐/Q button.

The FULL menu appears.

## 1 MENU button

FULL Menu

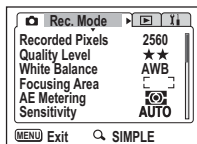

## 2



## 3

SIMPLE Menu

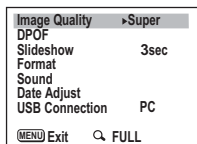

## 3

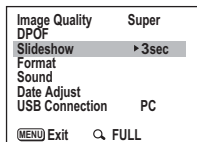

## 4①

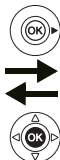

Pop Up Menu

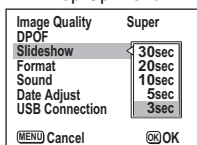

## 3

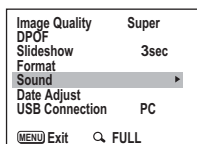

## 4②

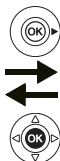

Select Screen

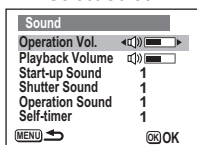



- The menu setting is saved even when the camera is turned off or switched to the Capture or Playback mode. If the camera is turned off or switched to the Capture or Playback mode while the SIMPLE menu displayed, the SIMPLE menu will be displayed the next time you press the MENU button.
- Interval shooting and bracket shooting is available even when the camera is set to display the SIMPLE menu. (When they are set to On.)



3

- If you press the MENU button before pressing the OK button to leave the menu, any changes to the settings will not be saved.
- Even after pressing the OK button to exit the menu, if you turn the camera off incorrectly (such as by removing the battery while the camera is turned on), any changes you have made to the settings will not be saved.
- You cannot return to the FULL menu display in the process of setting in the SIMPLE menu. Finish the setting and close the setting screen and settings before you return to the FULL menu.
- When displaying the SIMPLE menu, the items not included in the menu are set to their default setting (excluding language/言語, folder, start-up screen, screen effect, brightness of the LCD monitor, video output format, and world time). These settings will be reset to their status before displaying the SIMPLE menu when you return to the FULL menu display.
- The image quality setting in the SIMPLE menu is invalid in the FULL menu.
- You cannot display the SIMPLE menu in the USER mode.



## SIMPLE Menu List

Item	Description	Page
Image quality	For setting the recorded pixels and quality level of still pictures	p.91
DPOF	For setting which image and how many copies to print in advance before going to a print service	p.125
Slideshow	For playing recorded images successively	p.116
Format	For formatting the SD Memory Card	p.142
Sound	For adjusting the operation volume and playback volume and setting the type of start-up sound, shutter sound, key operation sound, self-timer sound, etc.	p.148
Date Adjust	For adjusting the date style, date and time	p.147
USB Connection	For changing the USB connection	p.153

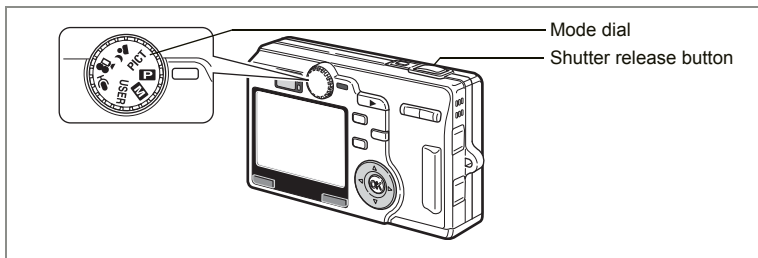

## 4

## Setting the Functions (Program Mode)

In **P** (Program mode), the camera automatically sets the shutter speed and aperture for taking still pictures. However, you can select other functions such as the flash or Continuous Shooting mode.

**1 Set the mode dial to **P**.**

**2 Set the functions you want to use.**

Refer to “Setting the Shooting Functions” (p.81 to p.103) for details of how to set the functions.

**3 Press the shutter release button halfway.**

The focus frame on the LCD monitor will light green when the camera is in focus.

**4 Press the shutter release button.**

The picture is taken.



If the USER mode has been set to P, the Program Mode Setting screen will appear by setting the mode dial to USER.

Taking Still Pictures p.27

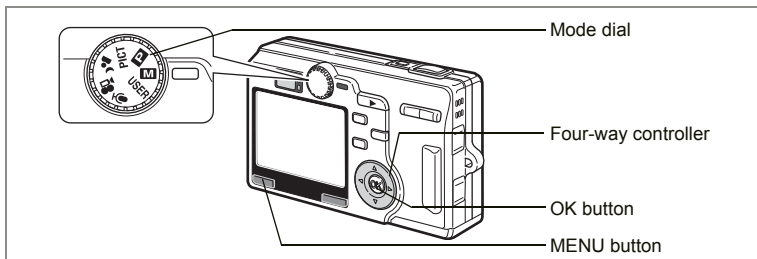

## Setting the Exposure Manually (Manual Exposure Mode)

You can set the shutter speed and aperture value manually.

- 1 Select **M** on the [ Rec.Mode] menu and press the four-way controller (▶).
- 2 Press the four-way controller (▲▼) to select M.
- 3 Press the OK button and then the MENU button.
- 4 Set the mode dial to **M**.

The camera is ready to take pictures in the Manual Exposure mode.

- 5 Use the four-way controller to change the shutter speed and aperture value.

- ◀ Increases the shutter speed.
- ▶ Reduces the shutter speed.
- ▲ Makes the aperture larger.  
(Reduces the aperture value.)
- ▼ Makes the aperture smaller.  
(Increases the aperture value.)



Aperture      Shutter speed

If the combination of shutter speed and aperture value do not give an appropriate exposure, a warning will be displayed.

(Lit)	If the deviation from the appropriate exposure is between $-0.3$ EV and $-2.0$ EV,  will light, and if between $+0.3$ EV and $+2.0$ EV  will light, and the value will be displayed.
(Blinking)	If the picture is underexposed at a setting lower than $-2.0$ EV,  blinks, and if overexposed at a setting higher than $+2.0$ EV,  blinks.
(Lit)	Metering is not possible.

## 6 Press the shutter release button.

The picture will be taken at the set shutter speed and aperture value.

Playing Back Still Pictures  p.29



- The shutter speed and aperture value will be saved when the camera is turned off.
- If the [USER] or **M** in the [Rec.Mode] menu has been set to **[M]**, the camera will be ready to make settings or take pictures in the Manual Exposure mode by setting the mode dial to **USER** or **M**.



- EV compensation is not available in this mode.
- [AUTO] cannot be selected for the sensitivity or flash mode when in the Manual Exposure mode.
- When the focus mode is set to the Manual Focus or Focusing Area mode, press the OK button to use the four-way controller to adjust the focus. Press the OK button again to adjust the shutter speed or aperture value.

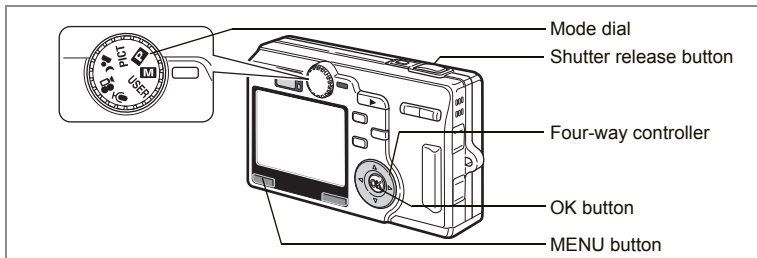

## Setting the Shutter Speed (Shutter-Priority Mode)

In this mode the shutter speed is set manually and the camera automatically sets the aperture value.

- 1 Select **[M]** on the [**Rec.Mode**] menu and press the four-way controller (▶).
- 2 Press the four-way controller (▲▼) to select Tv.
- 3 Press the OK button and then the MENU button.
- 4 Set the mode dial to **[M]**.

The camera is ready to take pictures in the Shutter-Priority mode.

- 5 Use the four-way controller (▲▼) to change the shutter speed.

- ▲ Reduces the shutter speed.
- ▼ Increases the shutter speed.

- 6 Press the shutter release button.

The picture will be taken.



Shutter speed

Playing Back Still Pictures p.29



- The set shutter speed will be saved when the camera is turned off.
- If the [USER] or **[M]** in the [**Rec.Mode**] menu has been set to [Tv], the camera will be ready to make settings or take pictures in the Shutter-Priority mode by setting the mode dial to **USER** or **M**.



- When the focus mode is set to the Manual Focus or Focusing Area mode, press the OK button to use the four-way controller to adjust the shutter speed or the focus. (The function of the four-way controller changes each time you press the OK button.)
- [Auto] cannot be selected for the flash when in the Shutter-Priority mode.

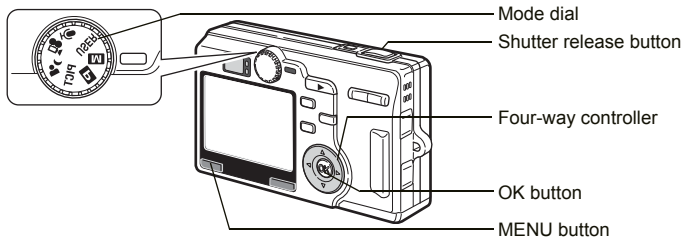

## Setting the Aperture Value (Aperture-Priority Mode)

In this mode the aperture value is set manually and the camera automatically sets the shutter speed.

- 1 Select **M** on the [ Rec.Mode] menu and press the four-way controller (▶).
- 2 Press the four-way controller (▲▼) to select **Av**.
- 3 Press the OK button and then the MENU button.
- 4 Set the mode dial to **M**.

The camera is ready to take pictures in the Aperture-Priority mode.

- 5 Use the four-way controller (▲▼) to change the aperture value.

- ▲ Makes the aperture larger.  
(Reduces the aperture value.)
- ▼ Makes the aperture smaller.  
(Increases the aperture value.)

- 6 Press the shutter release button.

The picture will be taken.



Aperture value

Playing Back Still Pictures p.29



- The aperture value will be saved when the camera is turned off.
- If the [USER] or **M** in the [ Rec.Mode] menu has been set to [**Av**], the camera will be ready to make settings or take pictures in the Aperture-Priority mode by setting the mode dial to **USER** or **M**.

**Caution**

- When the focus mode is set to the Manual Focus or Focusing Area mode, press the OK button to use the four-way controller to adjust the aperture value or the focus. (The function of the four-way controller changes each time you press the OK button.)
- [AUTO] cannot be selected for the sensitivity when in the Manual Exposure mode.

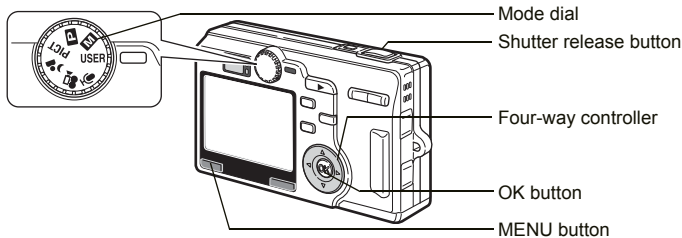

## Using Preset Function Settings (User Mode)

In the User mode, you can take pictures using the functions and settings registered in advance in the User mode.

**1 Select [USER] on the [📷 Rec.Mode] menu and press the four-way controller (▶).**

**2 Press the four-way controller (▲▼) to choose the capture mode.**

You can register P, M, Tv, Av, and Night-Scene for the USER mode.

**3 Press the OK button and then the MENU button.**

**4 Set the mode dial to USER.**

The camera is ready to take pictures in the set the capture mode.

**5 Press the shutter release button halfway.**

The focus frame on the LCD monitor will light green when the camera is in focus.

**6 Press the shutter release button.**

The picture is taken.



Registering Functions in the User Mode p.106



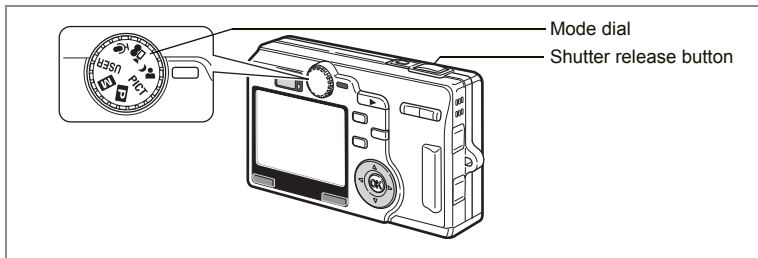

## Taking Pictures of Dark Scenes (Night-Scene Mode)

You can take pictures of dark scenes, such as nightscapes, with the appropriate settings.

### 1 Set the mode dial to .

The Capture Mode screen appears.

### 2 Press the shutter release button halfway.

The focus frame on the LCD monitor will light green when the camera is in focus.

### 3 Press the shutter release button.

The picture is taken.



- The total recording time will be longer when the noise reduction activates in the Night-Scene mode.
- If the USER mode has been set to the Night-Scene mode, the camera will be ready to take pictures in the Night-Scene mode by setting the mode dial to USER.



The shutter speed is slower when taking pictures of dark scenes. To prevent camera shake, secure the camera on a tripod or other surface.

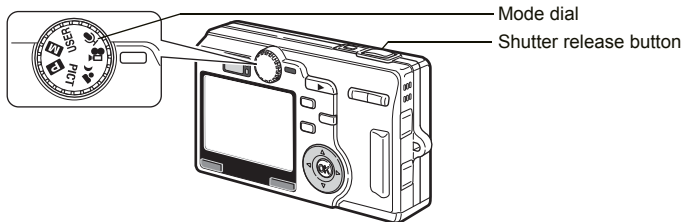

## Taking Movies (Movie Mode)

This mode enables you to shoot movies and sounds.

4

Taking Pictures

### 1 Set the mode dial to .

The following shooting information appears on the LCD monitor and the camera is ready to take movies.

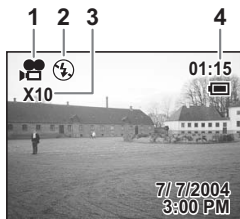

- 1 Movie mode icon
- 2 Flash Off icon
- 3 Time-lapse Movie setting
- 4 Recordable time

Press the shutter release button halfway to focus.



### 2 Press the shutter release button.

Shooting starts. You can change the size of the image using the Zoom button.

-  : makes the subject bigger.
-  : makes the subject smaller.

### 3 Press the shutter release button.

Shooting ends.

**Caution**

You cannot move the focusing area in the Movie mode.

## Keeping the Shutter Release Button Pressed

If you keep the shutter release button pressed for more than one second, pictures will be taken for as long as you keep the button pressed. Shooting stops when you take your finger off the shutter release button.



- The number of recorded pixels is fixed at 320 × 240 in the Movie mode.
- The file format of the movie is AVI (Motion JPEG), approx. 30 fps.
- Shooting also stops when you press the shutter release button fully after starting to shoot a movie with the self-timer.



- The flash will not discharge in the Movie mode.
- Continuous shooting, bracket shooting and interval shooting is not possible in the Movie mode.
- The LCD monitor cannot be turned off in the Movie mode.
- Sound cannot be recorded when [Time-lapse Movie] is set to On.
- Only the digital zoom can be used to change the size of the image in the Movie mode. Use the LCD monitor when recording movies using the digital zoom.
- The optical zoom can be used to change the size of the image in the Movie mode if it is before shooting.
- The zoom cannot be used when shooting movies in the Remote Control mode.
- The movie will be recorded on the SD Memory Card after shooting. This will take some time to get the camera ready for the next shooting.
- The recording time of the movie will be longer when [Time-lapse Movie] is set to on. This will take some time to get the camera ready for next shooting.

Taking Time-Lapse Movies p.79

Playing Back Movies p.113

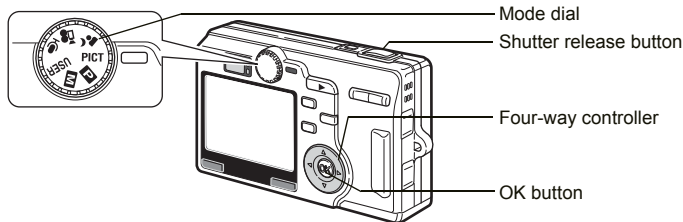

## Selecting the Picture Mode According to the Shooting Scene (Picture Mode)

4

You can select the Picture mode according to the shooting scene. There are twelve available modes in the Picture mode.

	Landscape	Lets you capture the natural colors of landscape views.
	Flower	Lets you take brightly colored flower pictures.
	Portrait	Lets you take portraits with spatial effect, by emphasizing the person.
	Self-Portrait	Lets you take pictures of yourself or be included in pictures.
	Sports	Lets you take sports scenes.
	Surf & Snow	Lets you take photos against dazzling backgrounds like beaches or snow-covered mountains.
	Autumn Colors	Lets you take colorful pictures of trees in autumn.
	Sunset	Lets you reproduce the beautiful colors of the sunrise or sunset.
	Museum	Lets you take pictures of works of art in museums and galleries.
	Food	Lets you take appetizing pictures of prepared food.
	3D	Lets you take 3D pictures.
	Panorama Assist	Lets you take pictures to form a panorama picture.

- 1 Set the mode dial to PICT and press the four-way controller (▲▼).**  
The Picture Mode screen appears.
- 2 Use the four-way controller (▲▼◀▶) to choose the desired mode.**  
For example, select (Landscape mode).

- 3 Press the OK button.**
- 4 Press the shutter release button halfway.**

The focus frame on the LCD monitor will light green when the camera is in focus.

- 5 Press the shutter release button.**

The picture is taken.

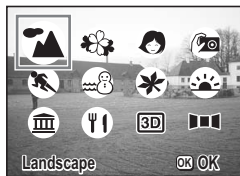

In the Picture mode, the exposure chart, EV compensation, white balance, sharpness, saturation, contrast and flash are automatically set to their default settings. (You can change the EV compensation and flash settings.)

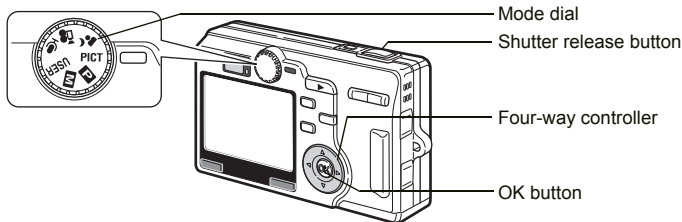

## Taking 3D Pictures (3D Image Mode)

You can take 3D pictures and view them by the parallel method or cross method.

The default setting is [Parallel]. If you print out 3D pictures for viewing by the parallel method and look at them through the optional 3D image viewer, the image will appear in three dimensions.

You can also take 3D pictures for viewing by the cross method. Refer to “Selecting the Viewing Mode” (p.62) for instructions on taking pictures by the cross method.

### 1 Set the mode dial to PICT and press the four-way controller (▲▼).

The Picture Mode screen appears.

### 2 Use the four-way controller (▲▼◀▶) to select 3D (3D Image mode).

### 3 Press the OK button.

The screen for taking the first image appears on the left of the LCD monitor.

### 4 Take the first image.

Hold the camera so that the subject is in the middle of the left half of the screen and press the shutter release button. The image appears in the left half of the LCD monitor. The right half of the screen is for taking the second image.



**5** Move the camera to the right without changing your stance.

**6** Take the second image.

Make sure that the subject is in the middle of the right half of the screen and press the shutter release button.

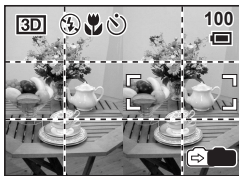

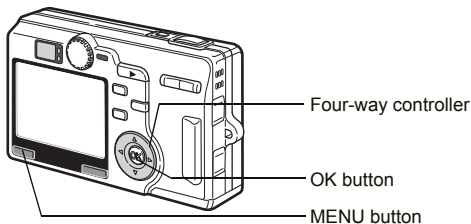

## Selecting the Viewing Mode

### 1 Press the MENU button in the Capture mode.

The [📷 Rec.Mode] menu appears.

### 2 Use the four-way controller (▲▼) to select [3D Mode] and press the four-way controller (▶).

### 3 Use the four-way controller (▲▼) to select ↑↑ (Parallel) or ✕ (Cross).

To view pictures with the 3D image viewer, select ↑↑.

You can view both ↑↑ and ✕ pictures without the image viewer.

### 4 Press the OK button and then the MENU button.

The camera returns to the Capture Mode screen.

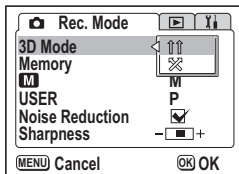

- To cancel the 3D Image mode, change to another Capture mode.
- A three-dimensional effect will not be achieved if the subject moves before the second image is taken. When taking a person, you are recommended to ask your model to stay as still as possible and to take the second picture as quickly as you can. It is easier to take the pictures if you use a tripod or appropriate base.
- As a guide, the camera should be moved about 1/40 of the distance between the camera and the subject. For example, if the subject is 3m away, the distance the camera should be moved will be  $3\text{m} \div 40 = 7.5\text{cm}$ . However, as the way people see three-dimensional images differs from person to person, there is no need to be too concerned. Refer to the table below for a simple guide to how far to move the camera.

Distance to subject	0.1m	0.3m	0.5m	1m	3m	5 m
Camera movement	0.5cm	1cm	1.5cm	2.5cm	7.5cm	13cm



### Viewing 3D Pictures by the Parallel Method and Cross Method

As our eyes are positioned about 6 cm or 7 cm apart, there is a very slight deviation between what we see with our right eye and what we see with our left eye. The difference is processed by our brain to produce a three-dimensional image. This principle is applied to taking and viewing 3D pictures.

3D pictures can be viewed by the parallel method where the left and right lines of vision are virtually parallel, as when looking at a distant scene, or the cross method where the left and right lines of vision are crossed, as when you cross your eyes. A certain amount of practice may be necessary to view 3D pictures without using the viewer.

### How to Assemble the 3D Image Viewer

Assemble the 3D image viewer (optional) as shown below.

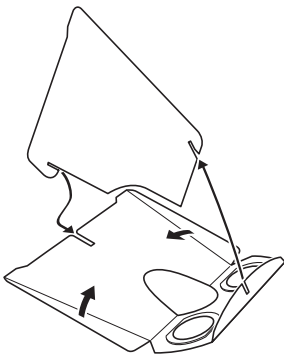

## How to View 3D Pictures Using the 3D Image Viewer

Print out the pictures so that they are about 11 cm or 12 cm wide and place the divider of the 3D image viewer in the middle of the two.

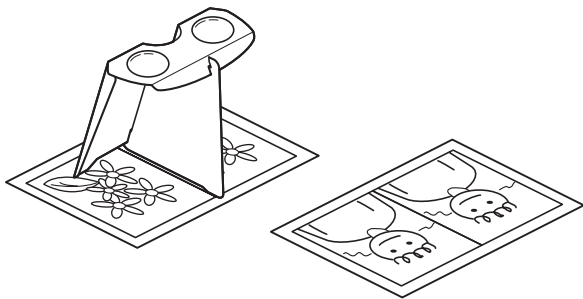

4



As the distance between the left and right eyes differs from person to person, some people may have difficulty obtaining a three-dimensional effect even when looking at prints that are the same size. It may be especially difficult if the pictures are very large or very small. Try different sizes until the right effect is achieved.



- Never look at the sun through the 3D image viewer.
- Do not leave the 3D image viewer where it is exposed to direct sunlight as this may lead to fire.

## Example of a 3D Picture (Parallel Method)



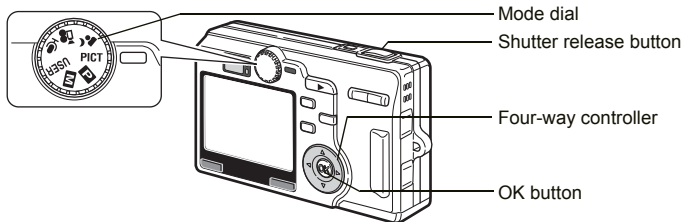

## Taking Panorama Pictures (Panorama Assist Mode)

4

Taking Pictures

You can take a number of images and join them together to form a panorama picture. The panorama softwares supplied with the camera (ACDSee for PENTAX and ACD photostitcher) and a computer are necessary for joining the images. The Panorama Assist mode enables you to overlap the edges of the images so that they are easier to join together later into a panorama picture.

### 1 Set the mode dial to PICT and press the four-way controller (▲▼).

The Picture Mode screen appears.

### 2 Use the four-way controller (▲▼◀▶) to select ■■■ (Panorama Assist mode).

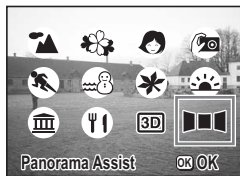

### 3 Press the OK button.

### 4 Use the four-way controller to choose the direction in which the images will be joined.

- ◀ Joins the images at the left.
- ▶ Joins the images at the right.
- ▲ Joins the images at the top.
- ▼ Joins the images at the bottom.

The example shows the images when ▶ is selected.



## 5 Take the first image.

Press the shutter release button to take the first image. The right edge of the image appears in half-transparent form on the left of the LCD monitor.



## 6 Move the camera to the right and take the second image.

Move the camera until the half-transparent image and the actual view overlap and press the shutter release button. Repeat Steps 5 and 6 to take the third and subsequent images.



## 7 Press the OK button.

The screen returns to Step 4.



To cancel the Panorama Assist mode, change to another mode.



- The camera cannot join the images. Use the panorama softwares supplied with the camera (ACDSee for PENTAX and ACD photostitcher). Refer to “Viewing Digital Camera Images on a PC” for instructions on creating panorama pictures.
- Continuous shooting is not possible in the Panorama Assist mode.

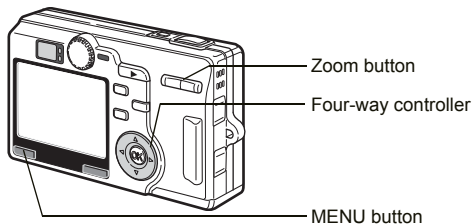

## Using the Zoom

You can use the zoom to change the size of the subject and take pictures in the Tele or Wide mode.

4

Taking Pictures

### 1 Press the Zoom button in the Capture mode.

▲ : makes the subject bigger.

◆◆◆ : makes the subject smaller.

When the digital zoom function is disabled, you can take pictures at up to five times magnification using the optical zoom. When the digital zoom function is enabled, you can further enlarge the subject to a maximum magnification equivalent to 20 times.

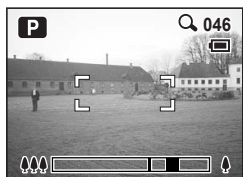
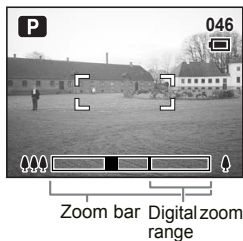

When digital zoom is enabled

Saving the Zoom Position p.104



You cannot use the optical zoom while shooting in the Movie mode.

## Setting the Digital Zoom Function to Off

### 1 Press the MENU button in the Capture mode.

The [📷 Rec.Mode] menu appears.

### 2 Use the four-way controller (▲▼) to select [Digital Zoom].

### 3 Use the four-way controller (◀▶) to select (Off).

### 4 Press the MENU button.

The camera is ready to take pictures.

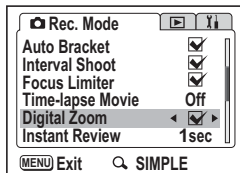

The digital zoom is disabled when you turn the LCD monitor off, even if the digital zoom function is set to On.



You should compose the picture on the LCD monitor when you use the digital zoom function.

Saving the Digital Zoom Function Setting p.104

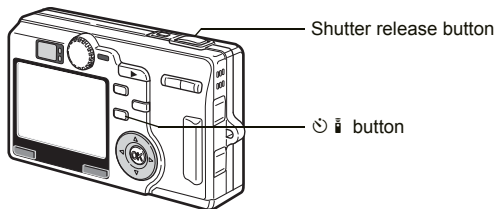

## Using the Self-Timer

In the self-timer mode, the picture is taken ten seconds or two seconds after the shutter release button is pressed.

4

**1 Press the  button in the Capture mode to display  or  on the LCD monitor.**

**2 Press the shutter release button.**

-  The self-timer is engaged and the self-timer lamp lights for about seven seconds. The picture is taken approximately three seconds after the self-timer lamp starts to blink.



-  The self-timer is engaged and the picture is taken approximately two seconds after the self-timer lamp starts to blink.



Focusing may be compromised if you move the camera while the self-timer lamp is blinking.



- The second count appears if you turn the LCD monitor on.
- To cancel the self-timer, press the MENU button while the second count is displayed.
- In the 3D Image mode, both the first and second images will be taken with the self-timer engaged.

Taking Pictures of Yourself  p.58



Troubleshooting "Subject is not in focus"  p.165

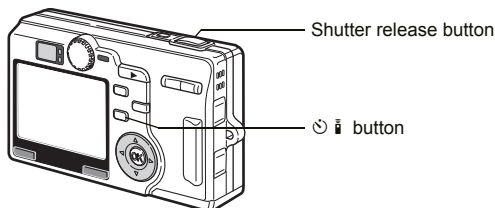



## Continuous Shooting (Continuous Shooting Mode)

You can switch the drive mode to Continuous Shooting mode. Pictures are taken continuously while the shutter release button is pressed.

**1 Press the  button in the Capture mode to display  on the LCD monitor.**

**2 Press the shutter release button halfway.**

The focus frame on the LCD monitor will light green when the camera is in focus.

**3 Press the shutter release button.**

Pictures are taken continuously while the shutter release button is pressed.

Shooting stops when you take your finger off the shutter release button.



- You can continue shooting until the SD Memory Card is full.
- The interval will vary according to the [Recorded Pixels] and [Quality Level] settings.



- The flash will not discharge in the Continuous Shooting mode.
- Continuous shooting is not available for the Movie, Panorama Assist or 3D Image mode.
- The focus, exposure and white balance are locked with the first image.

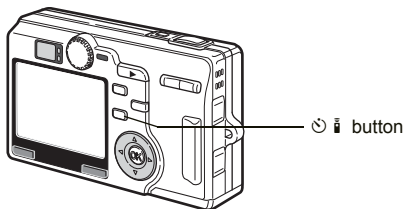

## Using the Remote Control Unit (optional)

You can switch the drive mode to the Remote Control mode and take pictures using the remote control unit E or F (optional).

4

Taking Pictures

- 1 Press the button in the Capture mode to display or on the LCD monitor.**

The self-timer lamp blinks slowly and the camera is ready to take pictures.

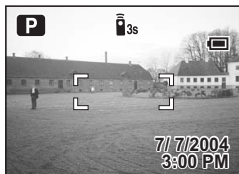

- 2 Press the shutter release button on the remote control unit.**

- The self-timer lamp blinks quickly and the picture is taken after approximately three seconds.
- The picture is taken immediately.



Focusing may be compromised if you move the camera while the self-timer lamp is blinking.



- The buttons on the camera can be used in the normal way.
- Ensure that the remote control unit is no more than four meters away from the front of the camera.

### Life of the Battery for the Remote Control Unit

A signal can be sent from the remote control unit to the camera approximately 30,000 times. Contact your nearest PENTAX customer service center if the battery needs changing. (A charge is required for changing the battery.)

## Using Zoom in the Remote Control Mode

With the remote control unit E (sold separately), you can change the magnification using the Zoom button and take pictures using the shutter button.

**1 Press the  button in the Capture mode to display  or  on the LCD monitor.**

The self-timer lamp blinks slowly and the camera is ready to take pictures using the remote control unit.

**2 Press the Zoom button on the remote control unit.**

The zoom bar is displayed. The zoom magnification changes each time the zoom button is pressed.

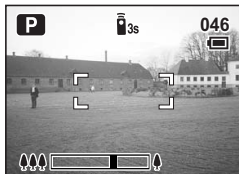

- The digital zoom cannot be used in the Remote Control mode.
- The zoom cannot be used in the Remote Control mode when the camera is set to the Movie or Super Macro mode.

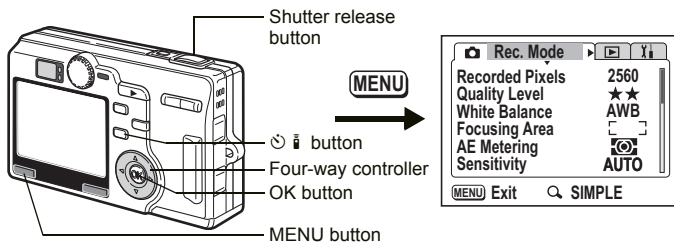

## Automatically Changing the Shooting Conditions (Auto Bracket)

4

Taking Pictures

You can take pictures automatically with three different exposure, white balance, sharpness, saturation and contrast settings.

### 1 Press the button in the Capture mode to display on the LCD monitor.

[Auto Bracket] is set to On by default. However, when the setting is changed to Off, will not appear even if you press button. Set [Auto Bracket] to On in the [Rec. Mode] menu in this case.

### 2 Press the shutter release button.

The bracket shooting will start. The Bracket Shooting screen appears when the shooting is finished.

Caution

- Check the pictures you have taken using the Playback mode.
- The flash will not discharge when [Exposure] is selected for the bracket shooting condition.
- In bracket shooting, the shooting will start from the standard value setting. Then the camera shoots with the [Negative (-)] and [Positive (+)] value.
- You cannot add the voice memo to the image shot in bracket shooting.
- Bracket shooting is not possible in the or mode.

## Setting the applied photo and bracket mount

- 1 Press the Menu button in the Capture mode.**  
The [Rec. Mode] menu appears.
- 2 Press the four-way controller (▲▼) to select [Auto Bracket].**
- 3 Press the four-way controller (▶).**  
The Auto Bracket Setting screen appears.
- 4 Press the four-way controller (◀▶) to select  (On)/  (Off) and press the four-way controller (▼).**
- 5 Press the four-way controller (▶).**  
Go to bracket setting.

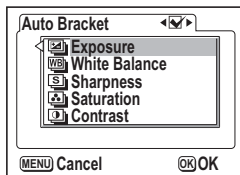

- 6 Use the four-way controller (▲▼) to select the condition for bracket shooting and press the OK button.**

If you selected [Sharpness], [Saturation] or [Contrast], skip to step 9.

- 7 Press the four-way controller (▼) to select [Exposure] or [White Balance].**

Go to [Bracket Amount].

- 8 Use the four-way controller (◀▶) to set the bracketing steps.**

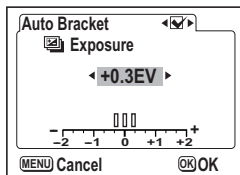

- 9 Press the OK button and then the MENU button.**

The camera switches to the Bracket Shooting mode.

Playing Back Still Pictures p.29

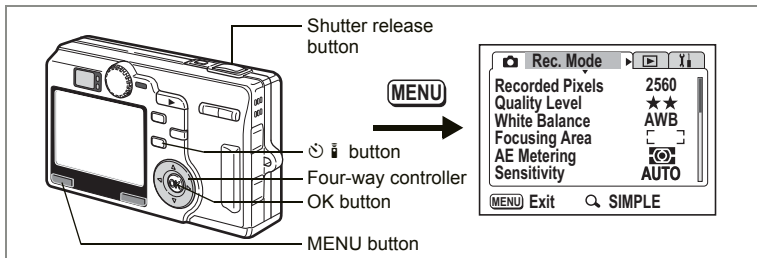



## Taking Pictures at Fixed Intervals (Interval Shooting)

4

In this mode still pictures are taken automatically at a fixed interval.

### 1 Press the button in the Capture mode to display on the LCD monitor.

[Interval Shoot] is set to On by default. However, when the setting is changed to Off,  will not appear even if you press  button. Set [Interval Shoot] to On in the [📷Rec. Mode] menu in this case.

### 2 Press the shutter release button.

Interval shooting will start with the following settings.

- Interval 0min 10sec
- Number of shot 02
- Start time 0hr 0min

The camera turns off automatically when shooting is finished.



- Interval shooting can be set at intervals of 10 seconds to 4 minutes in units of 1 second, and intervals of 4 minutes to 99 minutes in units of 1 minute. Intervals of less than 10 seconds cannot be set.
- The number of pictures can be set in the range of 2 to 99 pictures.
- The start time can be set between 0 min. and 23 hr. 59 min. in units of 1 minute.
- If the start time is set to 0 min., the first picture will be taken as soon as the shutter release button is pressed.
- The remaining number of pictures and interval time will be displayed on the LCD monitor when you press the power switch on during standby. If you press the Menu button, the message “Stop interval shooting?” will be displayed. To cancel interval shooting, press the OK button.
- Interval shooting stops and the camera turns off automatically when the SD Memory Card runs out of memory space.



- You cannot add a voice memo to an image shot in interval shooting.
- Interval shooting is not possible in the or mode.

### Setting the interval, number of shot, and start time

#### 1 Press the Menu button in the Capture mode.

The [ Rec.Mode] menu will be displayed.

#### 2 Press the four-way controller (▲▼) to select [Interval Shoot].

#### 3 Press the four-way controller (▶).

The Interval Shooting menu will be displayed.

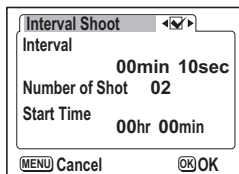

#### 4 Press the four-way controller (◀▶) to select (On)/ (Off) and press the four-way controller (▼).

#### 5 Press the four-way controller (▶).

[Interval] is selected.

## 6 Set the interval time.

1. **Press the four-way controller (▶).**  
▲▼ will be displayed above and below the minutes.
2. **Use the four-way controller (▲▼) to change the minutes, then press (▶).**  
▲▼ will be displayed above and below the seconds.
3. **Use the four-way controller (▲▼) to change the seconds, then press (▶).**
4. **Press the four-way controller (▼).**  
The frame will move to [Number of shoot].

## 7 Press the four-way controller (▶).

▲▼ will be displayed above and below the number of pictures.

## 8 Use the four-way controller (◀▶) to select the number of pictures and press the four-way controller (▶).

## 9 Press the four-way controller (▼).

The frame will move to [Start Time].

## 10 Set the time to start shooting.

1. **Press the four-way controller (▶).**  
▲▼ will be displayed above and below the hours.
2. **Use the four-way controller (▲▼) to change the hours, then press (▶).**  
▲▼ will be displayed above and below the minutes.
3. **Use the four-way controller (▲▼) to change the minutes, then press (▶).**

## 11 Press the OK button and then the MENU button.





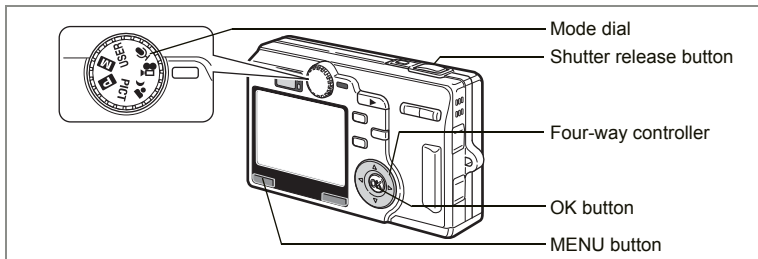

Playing Back Still Pictures  p.29





## Taking Time-lapse Movies

This mode lets you take movies at a delayed frame rate so that when you play back the movie, the action appears speeded up.

- 1 Set the mode dial to .**
- 2 Press the MENU button.**  
The [  Rec.Mode ] menu appears.
- 3 Use the four-way controller ( ) to select [Time-lapse Movie] and press the four-way controller (.**
- 4 Use the four-way controller ( ) to choose [Off], [**x2**], [**x5**], [**x10**] or [**x20**].**
- 5 Press the OK button and then the MENU button.**  
The camera is ready to take movies.
- 6 Press the shutter release button.**  
Shooting in the Time-lapse Movie mode starts.





- Off ( $\times 1$ ) is the normal setting for movies (30 frames per second). Each time  $\times 2$  or  $\times 5$  is selected, the number of frames taken per second is reduced to  $1/2$  or  $1/5$ .
- As movies are normally played back at the rate of 30 frames per second, movies taken at  $\times 2$  appear to be played back at twice the normal speed and movies taken at  $\times 5$  appear to be played back at five times the normal speed.
- Sound cannot be recorded.



Taking Movies  p.56

# Setting the Shooting Functions

## Changing the Mode







The Capture mode is for taking pictures and the Playback mode is for playing back or deleting images.

### Switching between the Capture Mode and Playback Mode

- To change from the Capture mode to the Playback mode, press the  Playback button.
- To change from the Playback mode to the Capture mode, press the  Playback button or press the shutter release button halfway.

## Selecting the Capture Mode

### Capture Modes

 P	Program mode	The basic picture-taking mode.	p.48
 M	Manual Exposure mode	Lets you set the shutter speed and aperture value manually. You can also allocate Tv (Shutter-Priority) and Av (Aperture-Priority) using the  [Rec. Mode] menu.	p.49
USER	USER mode	Lets you activate the preset function settings.	p.54
	Voice Recording mode	Lets you use the camera as a voice recorder.	p.108
	Movie mode	Lets you take movies and sounds.	p.56
	Night-Scene mode	Lets you take dark scenes such as night views.	p.55
PICT	Picture mode	Lets you take pictures with settings appropriate for the shooting scene. There are 12 available modes in the Picture mode.	p.58

- 1 Turn the mode dial and match the indicator with one of the following:

  USER    PICT



## Displaying Shooting Information in the Capture Mode

You can display shooting information on the LCD monitor when taking pictures. The display mode can be changed by pressing the OK button.

### Display On

Shooting information is displayed when the power is turned on.

- |   |                 |
|---|-----------------|
| 1 Capture mode                          | 2 Flash mode    |
| 3 Focus mode                            | 4 Drive mode    |
| 5 Focus frame                           | 6 Card warning  |
| 7 Remaining number of recordable images |                 |
| 8 Battery indicator                     | 9 Date and time |
| 10 Exposure                             | 11 Aperture     |
| 12 Shutter speed                        |                 |

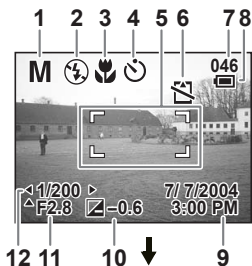

### Histogram Display

The brightness distribution of the image is displayed. The horizontal axis shows the brightness (darkest at the left end and brightest at the right end) and the vertical axis shows the number of pixels.

- |                   |                 |
|-------------------|-----------------|
| 1 Recorded pixels | 2 Quality level |
| 3 White balance   | 4 AE metering   |
| 5 Sensitivity     | 6 Histogram     |

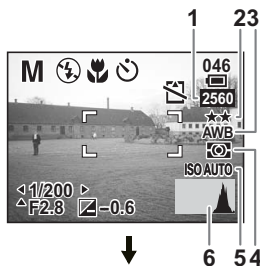

### Grid Display

A Grid appears to help you compose your pictures.

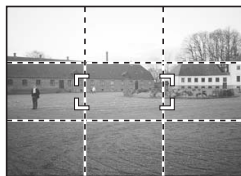

### Display Off

No shooting information is displayed.

- The focus frame appears in the Autofocus mode.
- If any of the modes are changed, such as the flash mode, the mode you have changed appears for a few seconds.

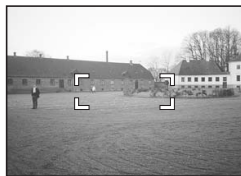



## LCD Monitor Off

The LCD monitor turns off.



↓  
Display On



- The display cannot be turned off in the ,  or  mode.
- Histogram Display, Grid Display and Display Off cannot be selected in the Voice Recording mode.



Shooting information will be displayed on the LCD monitor for a few seconds when the shutter release button or Zoom button is pressed or settings are changed (such as turning the mode dial).

Saving the Display Mode  p.104

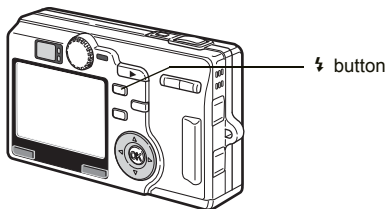

## Selecting the Flash Mode

### Flash Modes

(No icon)	Auto	The flash discharges automatically depending on the light conditions.
⚡	Flash off	The flash will not discharge, regardless of the brightness. Use this mode to take pictures at dusk or in museums etc. where flash photography is prohibited.
⚡	Flash on	The flash discharges regardless of the brightness.
⚡ A	Auto + red-eye reduction	This mode reduces the phenomenon of red eyes caused by the light from the flash being reflected in the subject's eyes. The flash discharges automatically.
⚡ ⚡	Flash On + red-eye reduction	This mode reduces the phenomenon of red eyes caused by the light from the flash being reflected in the subject's eyes. The flash will discharge regardless of lighting conditions.



- The flash is off when the Capture mode is set to the Movie, Super Macro, Continuous Shooting, Infinity-Landscape or Auto Bracket Shooting (Exposure) mode.
- The flash discharges a total of two times, one pre-flash and the second time to take the picture. (In the flash modes with red-eye reduction, the interval between the pre-flash and the main flash is longer.)

### 1 Press the ⚡ button in the Capture mode.

The flash mode changes each time the button is pressed and the icon appears on the LCD monitor.

The camera is ready to take pictures in the selected the flash mode.

Status of the Focus Status Lamp and Flash Status Lamp ESPp.28

Saving the Flash Mode ESPp.104

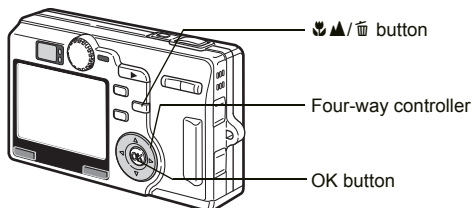

## Selecting the Focus Mode

### Focus modes

(No icon)	Autofocus mode	The camera focuses on the object in the autofocus area when the shutter release button is pressed halfway. Use this mode when the distance to the subject is more than 60 cm (24 in.).
	Macro mode	This mode is used when the distance to the subject is approx. 12 cm – 70 cm (5 in. – 28 in.). The camera focuses on the object in the autofocus area when the shutter release button is pressed halfway.
	Super Macro mode	This mode is used when the distance to the subject is approx. 3 cm – 14 cm (1 in. – 5.6 in.). The camera focuses on the object in the autofocus area when the shutter release button is pressed halfway.
	Infinity-Landscape mode	This mode is used for taking distant objects.
<b>MF</b>	Manual Focus mode	Adjust the focus manually with the four-way controller.
	Focusing Area mode	The position of the autofocus area is changed.

Saving the Focus Mode p.104

### 1 Press the button in the Capture mode.

The focus mode changes each time the button is pressed and the icon appears on the LCD monitor.

The camera is ready to take pictures in the selected the focus mode.



- The default setting is the Autofocus mode.
- The zoom is fixed at the wide-angle position in the Super Macro mode.
- The Focusing Area mode cannot be selected in the Movie (see p.56) and 3D Image (see p.60) modes.
- The flash will not discharge in the Super Macro and Infinity-Landscape modes.
- The Focus Limit setting is saved when the focus mode is changed.



If you take a picture while looking through the viewfinder when the focus mode is set to the Macro or Super Macro, the range of the resulting picture will differ from what was seen in the viewfinder. Be sure to check the image on the LCD monitor.

4

## Manual Focus

When the mode is set to the **MF** (Manual Focus) mode, a frame appears in the center of the display. Then press the four-way controller (▲▼) to enlarge the frame to full screen and display the indicator. Use the four-way controller (▲▼) to adjust the focus while watching the indicator on the LCD monitor.



For distant focus



For closer focus



Indicator

After the focus is set, press the OK button or take your finger off the four-way controller (▲▼). The screen returns to the normal display about two seconds later.



When focusing, hold down the four-way controller (▲▼) to focus quickly.



## Changing the Focusing Point



In the Autofocus mode, you can change the focusing point by moving the focus frame.

- 1 In the  (Focusing Area) mode, press the four-way controller (   ).**

Moves the focus frame [ ] (Focusing area).

- 2 Press the OK button.**

The focus frame is fixed in its new position.

To return the focus frame to its original location, press the   /  button again.

Troubleshooting "Subject is not in focus"  p.165



The display mode cannot be changed in the Focusing Area mode.

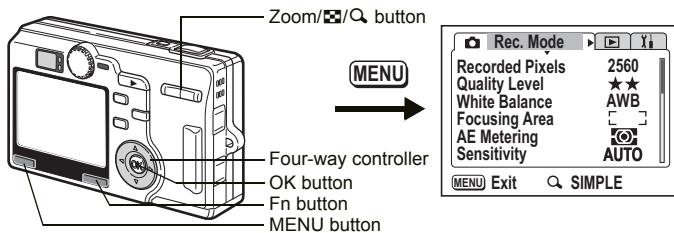

## Selecting the Recorded Pixels

You can choose the number of recorded pixels from [2560×1920], [2048×1536], [1600×1200], [1024×768] and [640×480].

The more pixels there are, the larger the picture and the bigger the file size. The data volume also varies depending on the quality level setting (see p.90).

### Number of Recorded Pixels

Size	Appropriate Use
2560×1920	Fine printing such as photo printing, large-sized printing, editing
2048×1536	
1600×1200	Postcard-sized printing, using on homepage, attaching to E-mail
1024×768	
640×480	

Sharp. Clear ↑

#### 1 Press the MENU button in the Capture mode.

The [CAM Rec.Mode] menu appears.

Press ▲/Q of the Zoom/☒/Q button if the SIMPLE menu is displayed.

#### 2 Use the four-way controller (▲▼) to select [Recorded Pixels] and press the four-way controller (▶).

#### 3 Use the four-way controller (▲▼) to change the size.

#### 4 Press the OK button and then the MENU button.

The camera is ready to take pictures.

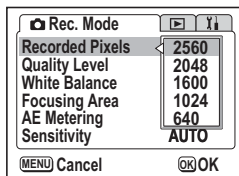



- The number of recorded pixels is fixed at 320×240 in the Movie mode.
- Selecting a large size produces a clear picture when it is printed out.
- The Recorded Pixels setting is saved when the camera is turned off.

Image Size and Quality p.23

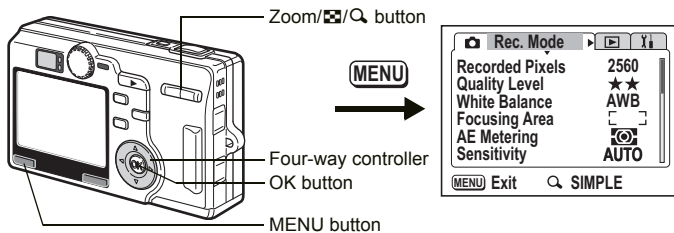

## Selecting the Quality Level

You can choose the image compression ratio (Quality levels). The more stars, the clearer the quality and the larger the volume. The recorded pixels setting also changes the picture volume (see p.88).

### Quality Levels

★★★	Best	Lowest compression ratio. Suitable for photo prints.
★★	Better	Standard compression ratio. Suitable for viewing the image on a computer screen.
★	Good	Highest compression ratio. Suitable for use such as creating websites.

#### 1 Press the MENU button in the Capture mode.

The [Rec.Mode] menu appears.

Press  $\uparrow$  /  $\downarrow$  of the Zoom button if the SIMPLE menu is displayed.

#### 2 Use the four-way controller ( $\blacktriangle$ $\blacktriangledown$ ) to select [Quality Level] and press the four-way controller ( $\blacktriangleright$ ).

#### 3 Use the four-way controller ( $\blacktriangle$ $\blacktriangledown$ ) to change the quality level.

#### 4 Press the OK button and then the MENU button.

The camera is ready to take pictures.

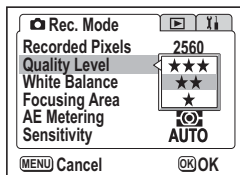

The Quality Level setting is saved when the camera is turned off.

Image Size and Quality see p.23

## Setting in the SIMPLE Menu

In the SIMPLE menu, the recorded pixels and quality level are set by the Image Quality. You can choose from the following four qualities.

Image Quality	Recorded Pixels	Quality Level
Superior	2560×1920	★★★
Super	2560×1920	★★
Normal	2048×1536	★★
Economy	640×480	★★

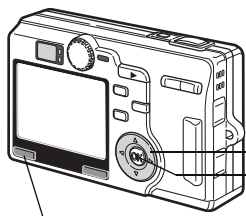

Four-way controller  
OK button  
MENU button

MENU

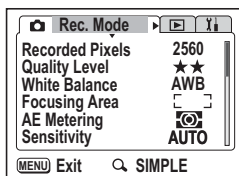

## Adjusting the White Balance

You can take pictures in natural colors by selecting the white balance best suited to the light conditions at the time of shooting.

### White Balance Modes

<b>AWB</b>	Auto	The camera adjusts the white balance automatically.
	Daylight	Use this mode when taking pictures outside in sunlight.
	Shade	Use this mode when taking pictures outside in the shade.
	Tungsten Light	Use this mode when taking pictures under electric or other tungsten light.
	Fluorescent Light	Use this mode when taking pictures under fluorescent light.
	Manual	Use this mode when taking pictures by adjusting the white balance manually.

- 1 Press the MENU button in the Capture mode.**  
The [Rec.Mode] menu appears.
- 2 Use the four-way controller (▲▼) to select [White Balance].**
- 3 Press the four-way controller (▶).**  
The White Balance screen appears.
- 4 Use the four-way controller (▲▼) to change the setting.**

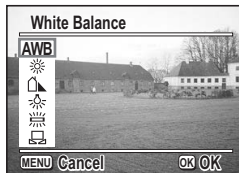

## 5 Press the OK button and then the MENU button.

The camera is ready to take pictures.

Saving the White Balance  p.104



The white balance is adjusted to match the flash, regardless of the white balance setting, when the flash is discharged.

### Manual Setting

Have a blank sheet of white paper ready.

#### 1 Select (manual) on the White Balance screen.

#### 2 Point the camera at the blank sheet of paper so that it fills the frame in the center of the screen.

#### 3 Press the Fn button.

The white balance is automatically adjusted. [Adjusting] appears on the LCD monitor while adjusting. [Complete] appears on the LCD monitor when adjusting is complete and the display returns to the White Balance screen.

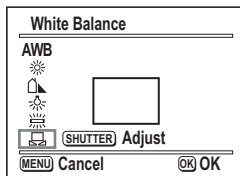

#### 4 Press the OK button and then the MENU button.

The camera is ready to take pictures.

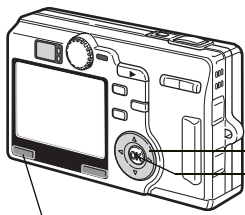

Four-way controller  
OK button  
MENU button

MENU

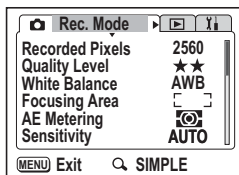

## Changing the Focusing Area

You can change the autofocus area (Focusing Area).

4

### Focusing Area

Multiple	Normal range
Spot	The autofocus range becomes smaller.

#### 1 Press the MENU button in the Capture mode.

The [Rec.Mode] menu appears.

#### 2 Use the four-way controller (▲▼) to select [Focusing Area] and press the four-way controller (▶).

#### 3 Use the four-way controller (▲▼) to change the setting.

#### 4 Press the OK button and then the MENU button.

The camera is ready to take pictures.

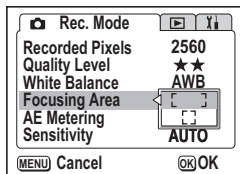

Caution

The autofocus area does not appear in the viewfinder. Always check the focusing area on the LCD monitor.

Saving the Focusing Area Setting p. 104



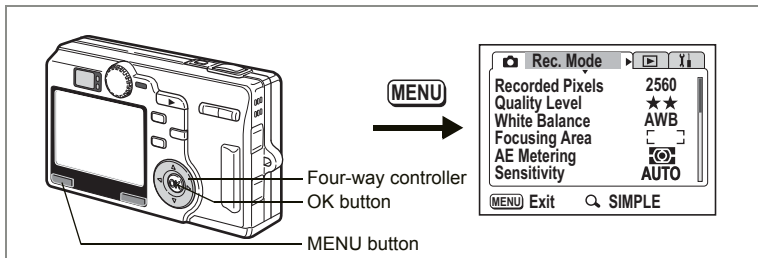

## Setting the Light Metering Range to Determine the Exposure

You can choose which part of the screen to use to measure the brightness and determine the exposure.

### AE Metering Modes

	Multi-segment	The exposure is determined by the entire screen.
	Center-weighted	The exposure is determined mainly by the center of the screen.
	Spot	The exposure is determined by the small area in the center of the screen only.

#### 1 Press the MENU button in the Capture mode.

The [📷 Rec.Mode] menu appears.

#### 2 Use the four-way controller (▲▼) to select [AE Metering] and press the four-way controller (▶).

#### 3 Use the four-way controller (▲▼) to change the AE metering mode.

#### 4 Press the OK button and then the MENU button.

The camera is ready to take pictures.

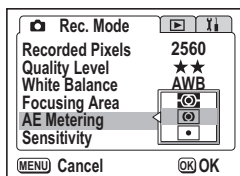

When is selected, the AE metering point moves in correspondence with movement of the focusing area. (☞p.87)

Saving the AE Metering Mode ☞p.104

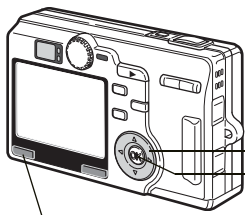

Four-way controller  
OK button  
MENU button

MENU

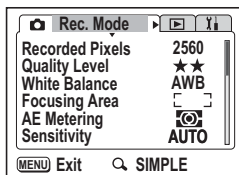

## Setting the Sensitivity

You can select the sensitivity to suit the brightness of the surroundings.

4

### Sensitivity

Auto	The camera sets the sensitivity automatically.
50	<ul style="list-style-type: none"> <li>The lower the sensitivity, the sharper the image and the less noise. The shutter speed will be slower in low light conditions.</li> <li>The higher the sensitivity, the faster the shutter speed in low light conditions to reduce camera shake, but the image may be affected by noise.</li> </ul>
100	
200	
400	

#### 1 Press the MENU button in the Capture mode.

The [Rec.Mode] menu appears.

#### 2 Use the four-way controller (▲▼) to select [Sensitivity] and press the four-way controller (▶).

#### 3 Use the four-way controller (▲▼) to change the sensitivity.

#### 4 Press the OK button and then the MENU button.

The camera is ready to take pictures.

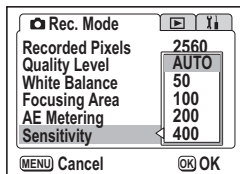

[AUTO] cannot be selected in the Manual Exposure mode.

Saving the Sensitivity p.104

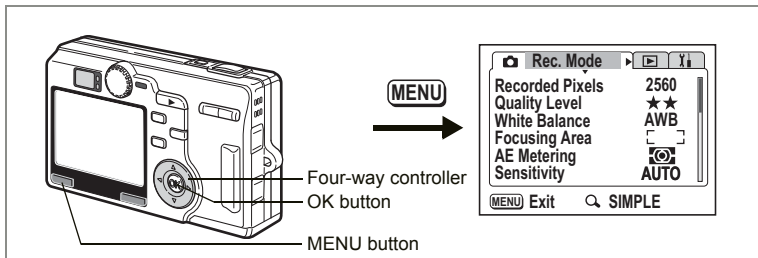

## Adjusting the Focus Limit

You can adjust the focus quickly by setting the focus limit to  (On). This limits the movement of the lens to only long range in the Autofocus mode and only close range in the Macro mode.

By setting the focus limit to  (Off), you can adjust the focus from approximately 12 cm to  $\infty$ , however focusing takes a longer time.

### 1 Press the MENU button in the Capture mode.

The [📷 Rec.Mode] menu appears.

### 2 Use the four-way controller (▲▼) to select [Focus Limiter].

### 3 Use the four-way controller (◀▶) to select (On)/ (Off).

### 4 Press the OK button.

The camera is ready to take pictures.

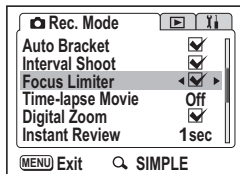

The picture will be out of focus in the Super Macro mode if the Focus Limit is set to  (Off).

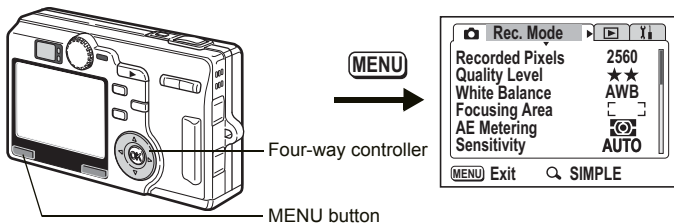

## Setting the Noise Reduction

Noise Reduction reduces the noise of the image after shooting. This function is available only in the Night-Scene, Manual Exposure, Shutter-Priority, and Aperture-Priority modes.

### 1 Press MENU button in the Capture Mode.

The [📷 Rec.Mode] menu appears.

### 2 Press the four-way controller (▲▼) to select [Noise Reduction].

### 3 Press the four-way controller (◀▶) to select (On)/ (Off).

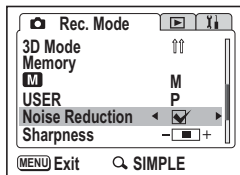

- The Noise Reduction setting is valid when the shutter speed is below 1/4 seconds in the Manual Exposure, Shutter-Priority, and Aperture-Priority modes.
- When Noise Reduction is set to  (On), processing images for recording requires twice as much time as when Noise Reduction is set to  (Off).

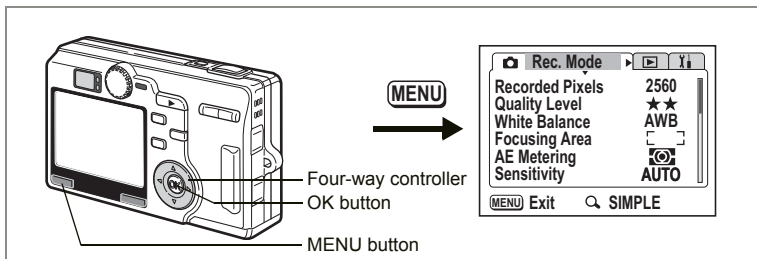

## Setting the Instant Review Time

You can choose the Instant Review time from 0.5 sec., 1 sec., 3 sec., 5 sec. and Off (no display).

### 1 Press the MENU button in the Capture mode.

The [📷 Rec.Mode] menu appears.

### 2 Use the four-way controller (▲▼) to select [Instant Review] and press the four-way controller (▶).

### 3 Use the four-way controller (▲▼) to change the display time.

### 4 Press the OK button and then the MENU button.

The camera is ready to take pictures.

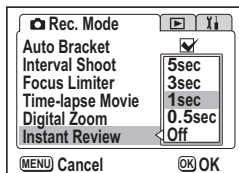

The Instant Review setting is saved when the camera is turned off.

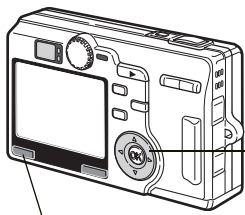

Four-way controller

MENU button

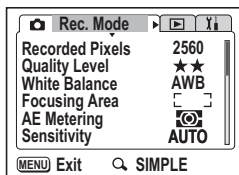

## Setting the Image Sharpness

You can choose whether you want the image to have sharp or soft outlines.

4

Taking Pictures

### 1 Press the MENU button in the Capture mode.

The [📷 Rec.Mode] menu appears.

### 2 Use the four-way controller (▲▼) to select [Sharpness].

### 3 Use the four-way controller (◀▶) to change the setting from (Soft) (Normal) or (Hard).

### 4 Press the MENU button.

The camera is ready to take pictures.

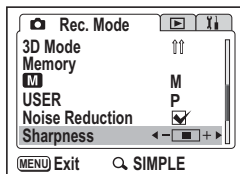

The Sharpness setting is saved when the camera is turned off.

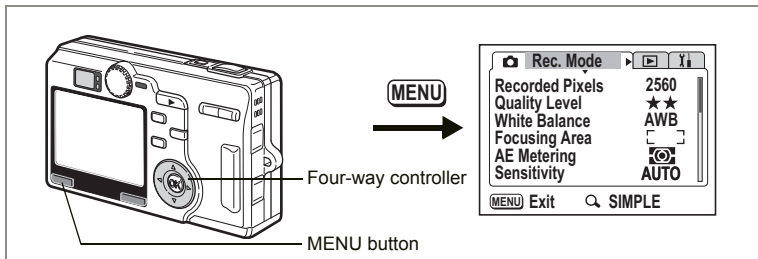

## Setting the Color Saturation

You can set the color saturation.

### 1 Press the MENU button in the Capture mode.

The [📷 Rec.Mode] menu appears.

### 2 Use the four-way controller (▲▼) to select [Saturation].

### 3 Use the four-way controller (◀▶) to change the setting from (Low) (Normal) or (High).

### 4 Press the MENU button.

The camera is ready to take pictures.

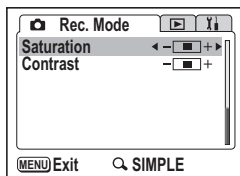

The Saturation setting is saved when the camera is turned off.

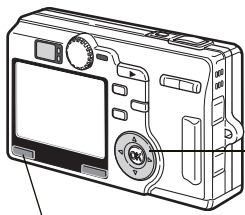

Four-way controller

MENU button

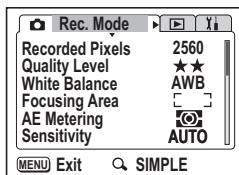

## Setting the Image Contrast

You can set the image contrast.

4

Taking Pictures

### 1 Press the MENU button in the Capture mode.

The [Rec.Mode] menu appears.

### 2 Use the four-way controller (▲▼) to select [Contrast].

### 3 Use the four-way controller (◀▶) to change the setting from [Low] [Normal] or [High].

### 4 Press the MENU button.

The camera is ready to take pictures.

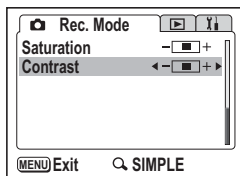

The Contrast setting is saved when the camera is turned off.



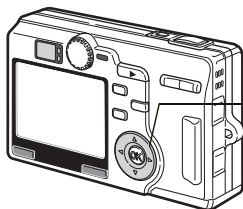

Four-way controller

## Setting the Exposure (EV Compensation)

You can adjust the overall brightness of the picture.

Use this function to take pictures that are intentionally overexposed or underexposed.

### 1 Press the four-way controller (◀▶) in the Capture mode.

The EV compensation bar appears.

### 2 Use the four-way controller (◀▶) to change the EV setting.

To brighten, set a positive (+) value. To darken, set a negative (-) value.

You can choose the EV setting in the range of -2.0 EV to +2.0 EV in 1/3 EV steps.

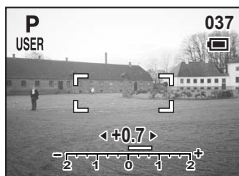

The camera is ready to take pictures in approximately 0.5 second.

Saving the EV Compensation Value p.104













The EV compensation bar does not appear when the display mode is set to [Histogram Display].

# Saving the Settings

## Saving the Menu Items (Memory)

You can choose whether you want the set values to be saved when the camera is turned off. If you select  (On), the settings will be saved in the status they were in immediately before the camera was turned off. If you select  (Off), the settings will be reset to the defaults when the camera is turned off.

Item	Description	Default Setting
Flash	The flash mode setting on the  button is saved.	<input checked="" type="checkbox"/>
Drive	The drive mode setting (  ) selected using the  button is saved.	<input type="checkbox"/>
Focus Mode	The focus mode setting on the  button is saved.	<input type="checkbox"/>
Zoom Position	The optional zoom position setting on the Zoom/  button is saved.	<input type="checkbox"/>
MF	The manual focus position is saved.	<input type="checkbox"/>
White Balance	The [White Balance] setting on the [  Rec.Mode] menu is saved.	<input type="checkbox"/>
Focusing Area	The [Focusing Area] setting on the [  Rec.Mode] menu is saved.	<input type="checkbox"/>
AE Metering	The [AE Metering] setting on the [  Rec.Mode] menu is saved.	<input type="checkbox"/>
Sensitivity	The [Sensitivity] setting on the [  Rec.Mode] menu is saved.	<input type="checkbox"/>
EV Compensation	The [EV Compensation] setting on the Zoom/  button is saved.	<input type="checkbox"/>
Digital Zoom	The [Digital Zoom] setting on the [  Rec.Mode] menu is saved.	<input checked="" type="checkbox"/>
DISPLAY	The LCD monitor display mode is saved.	<input type="checkbox"/>
File No.	The file number is saved. If a new SD Memory Card is inserted, file numbers are assigned sequentially.	<input checked="" type="checkbox"/>



- Menu items not included in [Memory] will also be saved in the settings selected on the menus for each function when the camera is turned off.
- The zoom position setting in the digital zoom range will not be saved even if [Zoom Position] is set to  (On) in [Memory].
- [Memory] can be set separately in the User mode and other capture modes.

**1 Press the MENU button in Capture mode.**

The [📷 Rec.Mode] menu appears.

**2 Use the four-way controller (▲▼) to select [Memory].**

**3 Press the four-way controller (▶).**

The [Memory] menu appears.

**4 Use the four-way controller (▲▼) to choose an item.**

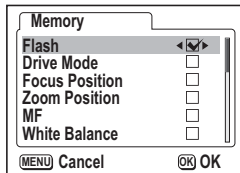

**5 Use the four-way controller (◀▶) to select  (On)/ (Off).**

**6 Press the OK button and then the MENU button.**

The camera is ready to take pictures.

## Registering Functions in the User Mode

Functions set with the the Capture mode on **USER** will be registered in the User mode.

### Functions Registered in the User Mode

Items Registered in the User Mode	Default Setting	Page
Flash Mode	Auto	p.84
Drive Mode	Normal	p.70 – 76
Focus Mode	Autofocus	p.85
Manual Focus Position	Infinity	p.86
Display Mode (Capture Mode)	Display On	p.82
Recorded Pixels	2560×1920	p.88
Quality Level	★★	p.90
White Balance	AWB (auto)	p.92
Manual White Balance	–	p.92
Focusing Area	Multiple	p.94
Zoom Position	Wide	p.68
AE Metering	 (Multi-segment)	p.95
Sensitivity	Auto	p.96
EV Compensation	±0.0	p.103
Auto Bracket	Exposure	p.74
Interval Shooting	–	p.76
Focus Limit	On	p.97
Time-lapse Movie	Off	p.79
Digital Zoom	On	p.68
Instant Review	1 sec.	p.99
3D Mode	↑↑ (Parallel)	p.60
Memory	All On	p.104
Noise Reduction	On	p.98
Sharpness	Normal	p.100
Saturation	Normal	p.101
Contrast	Normal	p.102
Fn Setting	▲ Recorded Pixels ▼ Quality Levels ◀ White Balance ▶ Focusing Area	p.156

## Memo

## Recording Sound (Voice Recording Mode)

You can record sound. The recordable time appears on the LCD monitor according to how much space is available on the SD Memory Card.

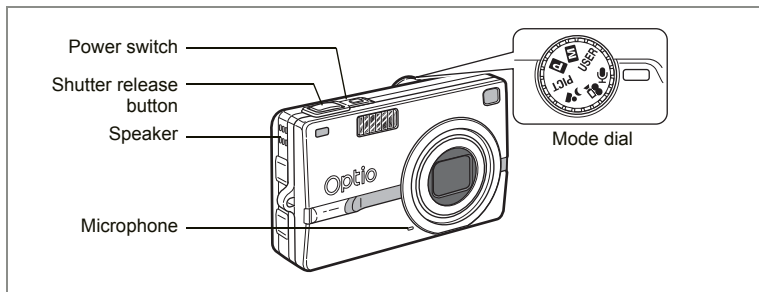

5

### 1 Set the mode dial to and press the power switch.

The recordable time appears on the LCD monitor.

- 1 Remaining recordable time
- 2 Recording time

### 2 Press the shutter release button.

Recording starts. The self-timer lamp and flash status lamp light during recording.

### 3 Press the shutter release button.

Recording stops.

### 4 To exit the Voice Recording mode, turn the camera off.



- Sound is saved in WAVE monaural files.
- The microphone is located on the front of the camera. Aim the camera to obtain the best sound.
- Recording continues while the shutter release button is pressed and stops when the shutter release button is released.



Only [▶ Playback] and [⚙ Set-up] menu can be selected in the Voice Recording mode.

# Playing Back Sounds

You can play back the recording you made in the Voice Recording mode.

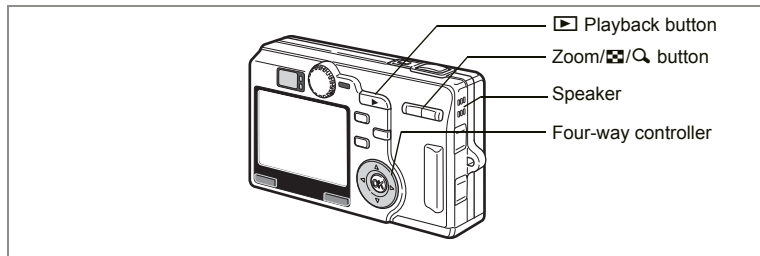

- 1 Press the **▶ Playback button** in the Voice Recording mode.
- 2 Use the four-way controller (**◀▶**) to choose the recording to play back.
- 3 Press the four-way controller (**▲**). Playback starts.

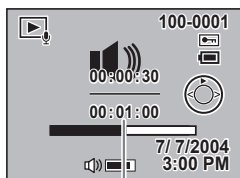

Total file recording time

- **The following operations can be performed during playback.**

- |                                       |   |
|---------------------------------------|---|
| Four-way controller ( <b>▲</b> )      | Pauses playback<br>Press again to resume playback |
| Four-way controller ( <b>◀</b> )      | Rewinds five seconds                              |
| Four-way controller ( <b>▶</b> )      | Advances five seconds                             |
| Zoom/Matrix/Quick button ( <b>⬆</b> ) | Increases the volume                              |
| Zoom/Matrix/Quick button ( <b>⬇</b> ) | Reduces the volume                                |

- 4 Press the four-way controller (**▼**). Playback stops.
- 5 Press the **▶ Playback button**. The camera switches to the Voice Recording mode.



If you entered the Playback mode from the Capture mode, the camera will switch to the Capture mode in Step 5. (p.33)

# Adding a Voice Memo

You can add a voice memo to a captured image.

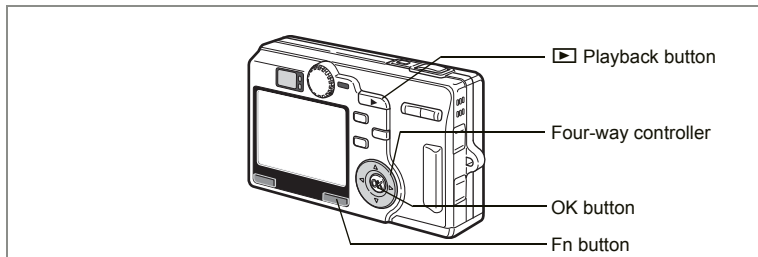

- 1 Enter the Playback mode.**
- 2 Press the four-way controller (◀▶) to select the image to attach the voice memo and press the Fn button.**



- 3 Press the four-way controller (◀).**  
The captured image and the Voice Memo screen appears on the LCD monitor while the image is displayed.



- 4 Press the OK button.**  
Recording starts. You can record for up to 30 seconds.
- 5 Press the OK button.**  
Recording stops.



- [ ] appears on the screen when a voice memo is added.
- A voice memo cannot be added to an image which already has a voice memo. Delete the old voice memo and record a new one. (p.119)



A voice memo cannot be added to the protected (🔒) images.



## Playing Back Images

You can play back images recorded on the SD Memory Card when a card is inserted in the camera.

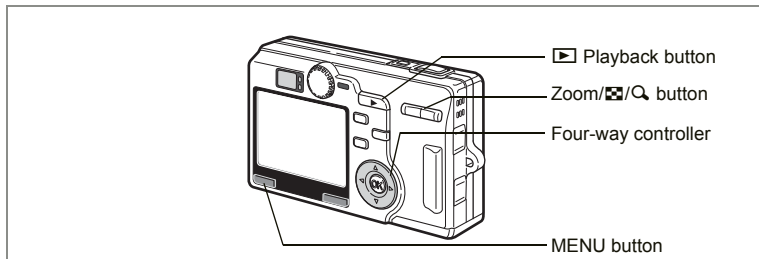

### Playing Back Still Pictures

Press the Playback button.

Refer to “Playing Back an Image” (p.29), or “Playing Back the Previous or Next Image” (p.29) for instructions on playing back images.

### Zoom Display

You can display images magnified up to four times. A guide to operation appears on the LCD monitor during magnification. (The magnification varies depending on the size of the image.)

- 1 Enter the Playback mode and use the four-way controller (◀▶) to choose the image to magnify.**
- 2 Press /Q on the Zoom/⌂/Q button.**

The image is magnified (1× to 4×). Holding down the button changes the magnification continuously.

- **The following operations can be performed while the magnified image is displayed.**

Four-way controller (▲▼◀▶)	Moves the position to be magnified
Zoom/⌂/Q button (▲)	Makes the image bigger
Zoom/⌂/Q button (◆◆◆)	Makes the image smaller



### 3 Press the OK button.

Zoom playback ends.



Movies, sounds, and rotated images cannot be magnified.

## Setting the Quick Zoom Function

You can display the image at maximum magnification simply by pressing the Zoom//Q button once during zoom playback.

### 1 Press the MENU button in the Playback mode.

The [ Playback] menu appears.

### 2 Press the four-way controller (▲▼) to select [Quick Zoom].

### 3 Use the four-way controller (◀▶) to select (On)/ (Off).

On : Pressing ▲/Q of the Zoom//Q button once displays the image at maximum magnification

Off : Pressing ▲/Q of the Zoom//Q button once magnifies the image in steps

### 4 Press the OK button.

The camera returns to the Playback mode.

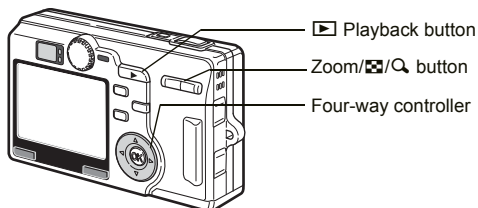

## Playing Back Movies

You can play back movies. You can play back the recording you made in the Voice Recording mode at the same time. A guide to operation appears on the LCD monitor during playback. Operations include playback, frame by frame playback (forward or reverse), pause and volume adjustment.

**1 Enter the Playback mode and use the four-way controller (◀▶) to choose the movie to play back.**

**2 Press the four-way controller (▲).**

Playback starts.

- **The following operations can be performed during playback.**

Four-way controller (◀)	Reverse playback
Four-way controller (▶)	Forward playback
Four-way controller (▲)	Pause
Zoom button (AAA/▲)	Adjusts the volume

- **The following operations can be performed while Pause is engaged.**

Four-way controller (◀)	Frame reverse
Four-way controller (▶)	Frame forward
Four-way controller (▲)	Releases the Pause function

**3 Press the four-way controller (▼).**

Playback stops and the screen returns to the first frame.

**4 Press the ▶ Playback button.**

The camera returns to the Capture mode.

Remaining playback time



## Displaying Shooting Information in the Playback Mode

Shooting information can be displayed on the LCD monitor in the Playback mode. Pressing the OK button changes the display mode.

### Display On

Shooting information is displayed.

- 1 Battery indicator
- 2 Voice Memo icon
- 3 Folder name
- 4 File name
- 5 Protect icon
- 6 Four-way controller operation guide
- 7 Shooting date and time
- 8 Volume
- 9 Shutter speed
- 10 Aperture

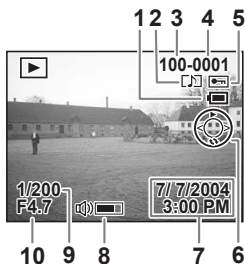

### Histogram Display

The brightness distribution of the image is displayed. The horizontal axis shows the brightness (darkest at the left end and brightest at the right end) and the vertical axis shows the number of pixels.

- 1 Recorded pixels
- 2 Quality level
- 3 White balance
- 4 Histogram
- 5 AE metering
- 6 Sensitivity

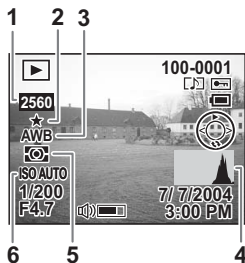

### Display Off

No shooting information is displayed.



Display On

Saving the Display Mode p.104

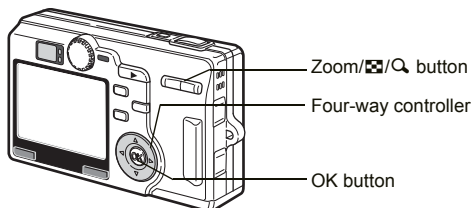

## Nine Image Display

You can display nine images at the same time.

- 1 Enter the Playback mode and use the four-way controller (◀▶) to choose an image.**
- 2 Press ▲▲/Matrix on the Zoom/Matrix/Quick button.**

Nine images appear with the selected image in the center.

Use the four-way controller (▲▼◀▶) to choose an image. When ten or more images have been recorded, the previous nine images appear when you press the four-way controller (▲) while the images in the top row are selected. Similarly, the next nine images appear when you press the four-way controller (▼) while the images in the bottom row are selected.



- 3 Press ▲▲/Matrix on the Zoom/Matrix/Quick button.**

The screen returns to full screen display of the selected image.



Pressing the OK button, button or Zoom/Matrix/Quick button returns the screen to full screen display of the selected image.

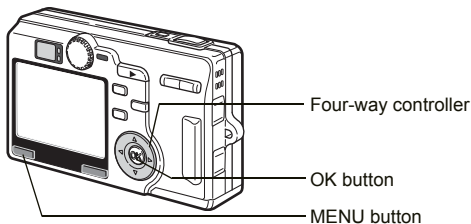

## Slideshow

You can play back all the images on the SD Memory Card or in the built-in memory continuously.

**1 Enter the Playback mode and use the four-way controller (◀▶) to choose the image with which to start the slideshow.**

**2 Press the MENU button.**

The SIMPLE menu or the [▶] Playback] menu appears.

**3 Use the four-way controller (▲▼) to select [Slideshow] and press the four-way controller (▶).**

**4 Use the four-way controller (▲▼) to change the playback interval.**

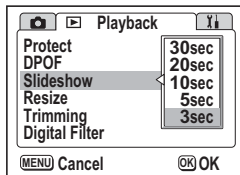

Choose the playback interval from the following: [3 sec], [5 sec], [10 sec], [15 sec], [20 sec], [25 sec], [30 sec].

**5 Press the OK button.**

[Start] appears on the LCD monitor and playback starts at the set interval.

Press any button, such as the OK button or MENU button, to stop the slideshow. [Stop] appears on the LCD monitor.



- The slideshow will continue until you press any button.
- The movies and pictures with a voice memo will be played through to the end before the next picture is played back, regardless of the set playback interval.
- Recordings made in the Voice Recording mode are not played back.

# Deleting Images, Movies and Sounds

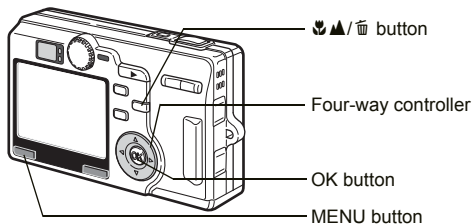

## Deleting a Single Image or Sound

You can delete single images or sounds.

**Caution**

- Once deleted, images cannot be restored.
- Protected images and sounds cannot be deleted. (p.122)

- 1 Enter the Playback mode and use the four-way controller (◀▶) to choose the image or sounds to delete.**
- 2 Press the button.**  
The Delete screen appears.
- 3 Use the four-way controller (▲) to select [Delete].**
- 4 Press the OK button.**  
The image or sound is deleted.

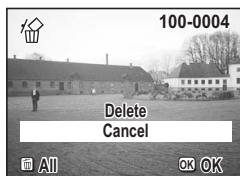

**memo**

- You can also delete images from Instant Review (p.99).
- You cannot delete protected images (with the icon).
- If [Quick Delete] is set to On in the [▶ Playback] menu, Step 3 can be omitted. (p.119)
- When you erase an image, the next image will be displayed. However, when you erase the image shot last, the previous image will be displayed.



## Deleting a Voice Memo only

If an image has a voice memo, you can delete the voice memo without deleting the image.

- 1 Enter the Playback mode and use the four-way controller (◀▶) to choose an image with a voice memo to delete.**
- 2 Press the /▲/🗑️ button.**  
The Delete screen appears.
- 3 Use the four-way controller (▲) to select [Delete Sound].**
- 4 Press the OK button.**  
The voice memo is deleted.



Select [Delete] in Step 3 above to delete both the image and the voice memo.

## Setting the Quick Delete Function

When the Quick Delete function is set to [On], the Delete screen appears with [Delete] or [Delete All] already selected.

- 1 Press the MENU button in the Playback mode.**  
The [ Playback] menu appears.
- 2 Press the four-way controller (▲▼) to select [Quick Delete].**
- 3 Use the four-way controller (◀▶) to select  (On)/  
 (Off).**
- 4 Press the OK button.**  
The camera is ready to take or play back images.

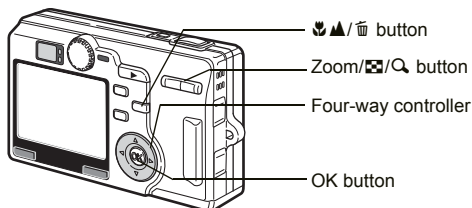

## Deleting Selected Images

You can select images to delete on the Nine Image Display.



- Once deleted, images cannot be restored.
- Protected images and sounds cannot be deleted. (p.122)

**1 Enter the Playback mode and press the ☹▲/🗑 of the Zoom/📷/🔍 button.**

Nine images appear with the selected image in the center.

**2 Press the ☹▲/🗑 button.**

The screen for selecting the images appears.

**3 Press the four-way controller (▲▼◀▶) to choose an image to delete.**

**4 Press the OK button.**

The check box of the chosen image is checked.

Repeat Steps 3 and 4 to choose the images to delete.

**5 Press the ☹▲/🗑 button.**

The Select and Delete screen appears.

**6 Press the four-way controller (▲) to select [Sel. and Del.].**

**7 Press the OK button.**

The selected images and sounds are deleted.

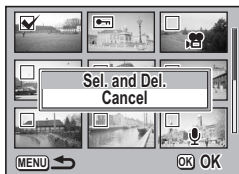

When the selected images are deleted, the remaining images will be displayed in ascending file number order, with the image with the smallest file number selected.

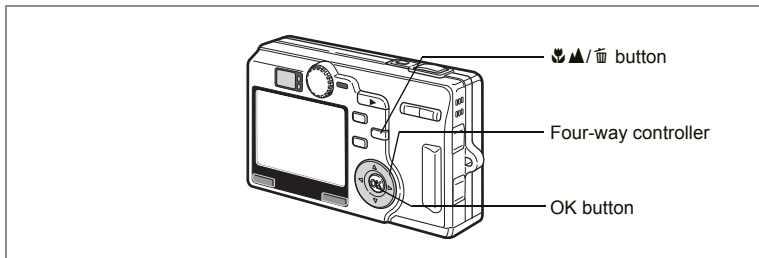

## Deleting All Images

You can delete all the images and sounds at once.



- Once deleted, images cannot be restored.
- Protected images and sounds cannot be deleted. (p.122)

**1 Enter the Playback mode and press the 🗑️ button twice.**

The Delete All screen appears.

**2 Use the four-way controller (▲) to select [Delete All].**

**3 Press the OK button.**

All the images and sounds will be deleted.



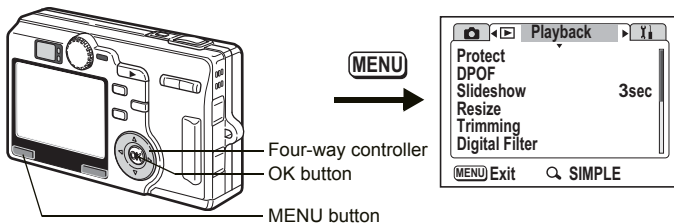

## Protecting Images and Sounds from Deletion (Protect)

You can protect images and sounds from being accidentally deleted.

- 1 Press the MENU button in the Playback mode.**  
The [▶ Playback] menu appears.
- 2 Use the four-way controller (▲▼) to select [Protect].**
- 3 Press the four-way controller (▶).**  
The screen for choosing an image appears.
- 4 Use the four-way controller (◀▶) to choose the image or sound to protect.**
- 5 Use the four-way controller (▲▼) to select [Protect].**  
Select [Unprotect] to cancel the Protect setting.
- 6 Press the OK button.**  
🔒 appears on the image or sound.

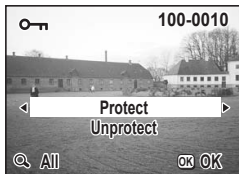
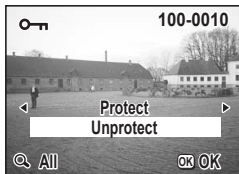

You can display the Protect screen simply by pressing the Fn button.  
(p.157)

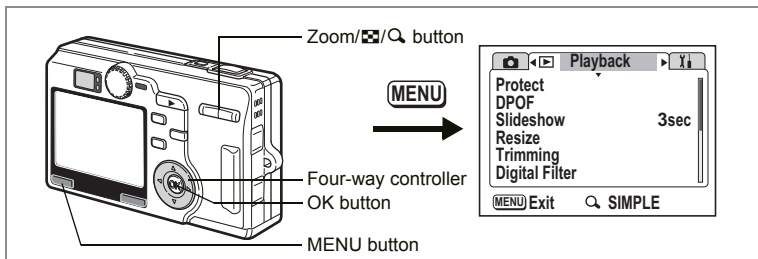

## Protecting All Image and Sounds

You can protect all the images and sounds.

### 1 Press the **MENU** button in the Playback mode.

The [▶ Playback] menu appears.

### 2 Use the four-way controller (▲▼) to select [Protect] and press the four-way controller (▶).

The screen for choosing a image appears.



### 3 Press the **Zoom/Matrix/Quality** button.

The Protect All screen appears.

### 4 Use the four-way controller (▲) to select [Protect].

### 5 Press the **OK** button.



Select [Unprotect] in Step 4 to cancel the Protect setting on all the images and sounds.



Even protected images and sounds will be deleted by formatting the SD Memory Card or built-in memory.

# Viewing Images on a TV

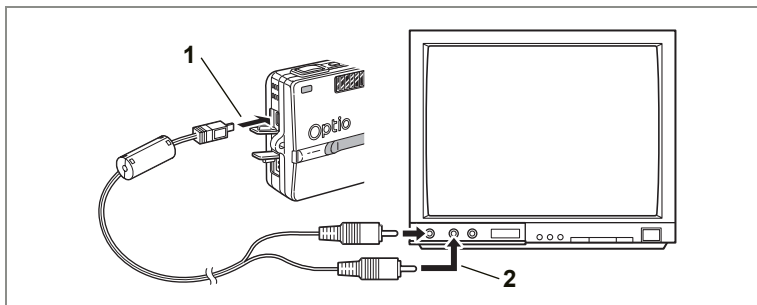

By using the AV cable, you can capture and play back images on a TV or other equipment with a video IN jack. Make sure that both the TV and the camera are turned off before connecting the cable.

- 1 Open the terminal cover and connect the AV cable.**
- 2 Connect the other end of the AV cable to the image input terminal and sound input terminal on the TV.**  
When using stereo sound equipment, insert the sound terminal into the L (white) terminal.
- 3 Turn the TV and camera on.**

Changing the Video Output Format Ⓜp. 153



If you intend to use the camera for a long time, use of the AC adapter D-AC8 (optional) is recommended. Refer to the operating manual for the TV or equipment to which the camera is connected.

# Setting the Printing Service (DPOF)

You can print the images on the SD Memory Card using a DPOF (Digital Print Order Format) compatible printer or at a printing service.

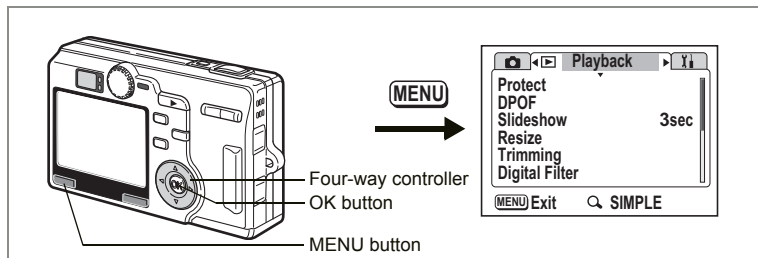

## Printing Single Images

Set the following items for each image.

Copies: Choose the number of copies up to a maximum of 99.

Date: Specify whether you want the date imprinted on the print or not.

- 1 Press the MENU button in the Playback mode.**  
The [▶ Playback] menu appears.
- 2 Use the four-way controller (▲▼) to select [DPOF].**
- 3 Press the four-way controller (▶).**  
The DPOF screen appears.
- 4 Use the four-way controller (◀▶) to choose an image to print, then press the four-way controller (▼).**  
The frame moves to [Copies].



**5 Use the four-way controller (◀▶) to choose the number of copies, then press the four-way controller (▼).**

The frame moves to [Date].

**6 Use the four-way controller (◀▶) to select  (On)/ (Off).**

(On): The date will be imprinted.

(Off): The date will not be imprinted.

**7 Press the OK button.**

Prints can be made according to the settings.



- You can display the DPOF screen simply by pressing the Fn button. (p.157)
- If DPOF settings have already been made for an image, the previous number of copies and date setting will be displayed.
- To cancel DPOF settings, set the number of copies to 0 and press the OK button.

6



- You cannot set the printing service for movies or sound-only files.
- Depending on the printer or printing equipment at the photo processing lab., the date may not be imprinted on the pictures even if the DPOF setting was made.
- Pictures may not be printed correctly when the camera is connected directly to a PictBridge-compatible printer if the number of copies exceeds 500.



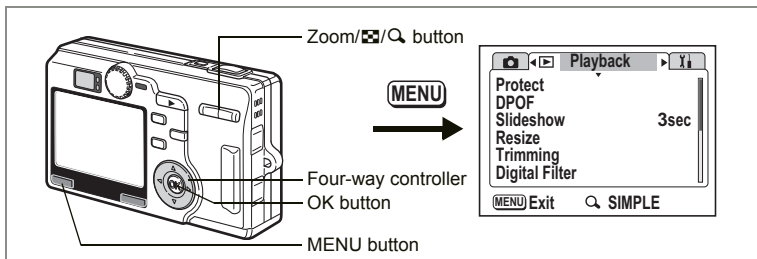

## Printing All Images

- 1 Press the MENU button in the Playback mode.**  
The [▶ Playback] menu appears.
- 2 Use the four-way controller (▲▼) to select [DPOF].**
- 3 Press the four-way controller (▶).**  
The DPOF screen appears.
- 4 Press ▲/Q of the Zoom/Matrix/Quality button.**
- 5 Use the four-way controller (◀▶) to choose the number of copies.**  
You can print up to 99 copies.
- 6 Press the four-way controller (▼).**  
The frame moves to [Date].
- 7 Use the four-way controller (◀▶) to select  (On)/ (Off).**  
 (On): The date will be imprinted.  
 (Off): The date will not be imprinted.
- 8 Press the OK button.**  
Prints can be made according to the settings.

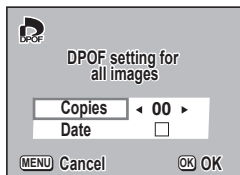

- The number of copies specified in the DPOF settings applies to all the images. Before printing, check that the number is correct.
- Pictures may not be printed correctly when the camera is connected directly to a PictBridge-compatible printer if the number of copies exceeds 500.



- Settings for single images are cancelled when settings are made for all images.
- DPOF settings cannot be made for movies or sound only files.

# Direct Printing Using PictBridge

By connecting the camera to a printer that supports PictBridge using the USB cable (I-USB17) supplied with the camera, you can print images directly from the camera without using a PC. Select the images you want to print and the number of copies on the camera after it has been connected to the printer.



- You are recommended to use the AC adapter D-AC8 (optional) while the camera is connected to the printer. The printer may not work properly or the image data may be damaged if the battery runs out of power while the camera is connected to the printer.
- Do not disconnect the USB cable during data transfer.
- Depending on the type of printer, not all the settings made on the camera (such as paper size and DPOF settings) may be valid.

## Connecting the Camera to the Printer

**1** Select  for [USB Connection Mode] on the [] Set-up] menu.

 “Changing the USB Connection Mode” (p.153)

**2** Connect the camera to the printer using the USB cable supplied with the camera.

The PictBridge menu appears.



While the camera is connected to a printer, if the printer settings are changed (such as when you attach an external cartridge), the display may return to the PictBridge menu.

## Printing Single Images

- 1 Use the four-way controller (▲▼) to select [Print One].**



- 2 Press the OK button.**

The Print This Image screen appears.

- 3 Use the four-way controller (◀▶) to choose the image to print.**

- 4 Use the four-way controller (▲▼) to choose the number of copies.**

You can print up to 99 copies.



- 5 Use the Fn button to select  (On)/ (Off).**

(On): The date will be imprinted.

(Off): The date will not be imprinted.

The Date cannot be set to  (On) if the printer is not compatible with date stamping.

- 6 Press the OK button.**

The screen to confirm the print setting appears. Proceed to Step 7 to start printing with the settings you have made. Proceed to “Changing the Paper Size” (p.132) to change the settings you have made.

- 7 Press the OK button.**

Printing starts. Press the OK button to return to Step 3 and print again. Press the MENU button to exit PictBridge.

## Printing All Images

**1 Use the four-way controller (▲▼) to select [Print All].**

**2 Press the OK button.**

The Print All screen appears.

Use the four-way controller (◀▶) to check the images and make sure you want to print them all.



**3 Use the four-way controller (▲▼) to choose the number of copies.**

The number of copies you choose applies to all the images.

**4 Use the Fn button to select  (On)/ (Off).**

(On): The date will be imprinted.

(Off): The date will not be imprinted.

The Date cannot be set to  (On) if the printer is not compatible with date stamping.

**5 Press the OK button.**

The screen to confirm the print setting appears. Proceed to Step 6 to start printing with the settings you have made. Proceed to "Changing the Paper Size" (p.132) to change the settings you have made.

**6 Press the OK button.**

Printing starts. Press the OK button to return to Step 2 and print again. Press the MENU button to exit printing.

## Printing Using the DPOF Settings

**1 Use the four-way controller (▲▼) to select [DPOF AUTOPRINT].**

**2 Press the OK button.**

The Print w/DPOF Settings screen appears. Use the four-way controller (◀▶) to check the images and the print settings.

**3 Press the OK button.**

The screen to confirm the print setting appears. Proceed to Step 4 to start printing with the settings you have made. Proceed to “Changing the Paper Size” (p.132) to change the settings you have made.

**4 Press the OK button.**

Printing starts. Press the OK button to repeat Steps 2 and 3 to print again. Press the MENU button to exit printing.

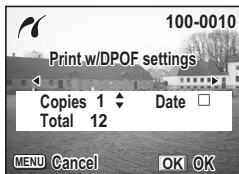

## Changing the Paper Size

**1 Press the Fn button.**

The screen to choose the size of the paper appears.

**2 Press the four-way controller (▲▼) to choose the size of the paper.**

**3 Press the OK button.**

The screen to confirm the print setting appears.

**4 Press the OK button.**

Printing starts. When Printing is finished, press the OK button to return to Step 3 if you want to print with the same settings again or press the MENU button to exit printing.



Only paper sizes displayed in white can be set. Paper sizes displayed in gray cannot be set, because they are not supported by the camera or printer.

## Disconnecting the Camera from the Printer

Disconnect the camera from the printer when you have finished printing.

- 1 Turn the camera off.**
- 2 Disconnect the USB cable from the camera.**
- 3 Disconnect the USB cable from the printer.**



If you press the MENU button while the “Continue printing?” message is displayed, the message “Safely remove USB cable” is displayed.

When you disconnect the USB cable from the camera, the camera automatically turns Off.

# Editing Images

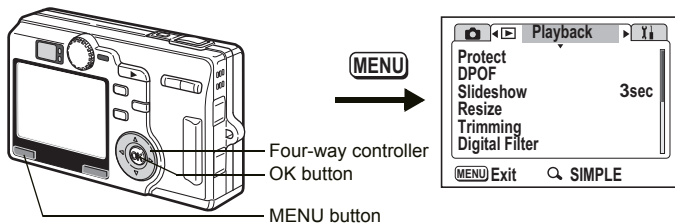

## Changing the Image Size and Quality

By changing the size and quality of a selected image, you can make the file smaller than the original. You can use this function to continue taking pictures when the card is full, by making the images smaller and overwriting the original images to make more space available in the memory.

6

Playback/Deleting/Editing

After changing the size and quality, the image can be saved as a new image or written over the original image.

- 1 Press the MENU button in the Playback mode.**  
The [▶ Playback] menu appears.
- 2 Use the four-way controller (▲▼) to select [Resize].**
- 3 Press the four-way controller (▶).**  
The Resize screen appears.
- 4 Use the four-way controller (◀▶) to choose the image to resize.**
- 5 Press the OK button.**  
The Size and Quality Options screen appears.

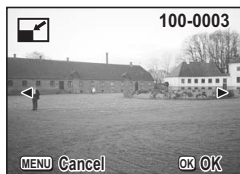



**6** Press the four-way controller (▶).

**7** Use the four-way controller (▲▼) to change the size and press the OK button.

**8** Press the four-way controller (▼).

The frame moves to [Quality Level].

**9** Press the four-way controller (▶).

**10** Use the four-way controller (▲▼) to change the quality and press the OK button.

**11** Press the OK button.

**12** Use the four-way controller (▲▼) to select [Overwrite] or [Save as].

**13** Press the OK button.

The resized image is saved.



- Movies cannot be resized.
- You cannot select a larger size than that of the original image.
- You cannot select a higher quality than that of the original image.

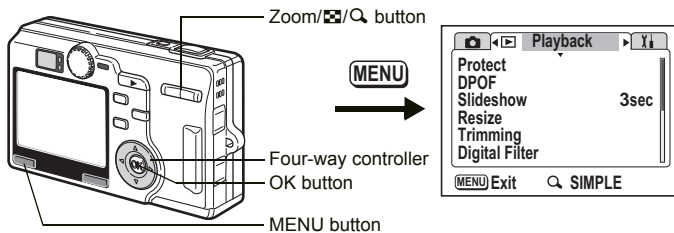

## Trimming Images

You can trim part of a picture and save it as a separate image.

- 1 Press the MENU button in the Playback mode.**  
The [▶ Playback] menu appears.
- 2 Use the four-way controller (▲▼) to select [Trimming].**
- 3 Press the four-way controller (▶).**  
The images that can be trimmed are displayed.
- 4 Use the four-way controller (◀▶) to choose an image to trim.**
- 5 Press the OK button.**  
The Trimming screen appears.

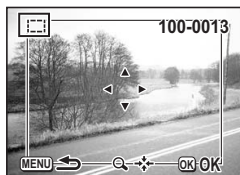

- 6 Trim the image.**
  - **Operations that can be performed on the Trimming screen**
    - Zoom/Matrix/Quality button: Changes the size of the trimming
    - Four-way controller (▲▼◀▶):  
Moves the trimming position up, down, left and right
    - MENU button: Returns to the screen for selecting an image
- 7 Press the OK button.**
- 8 Press the four-way controller (▶).**

**9** Use the four-way controller (▲▼) to select the quality level after trimming and press the OK button.

**10** Press the OK button.

The trimmed image is saved as a separate image.



- Movies cannot be trimmed.
- The image size is changed and saved.

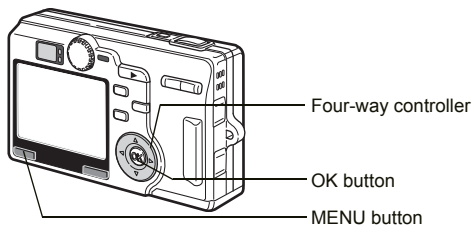

## Using Digital Filters to Edit Images

The filters consist of color filters such as red, blue and green, and illustration filter, slim filter, and soft filter. In the Digital Filter mode, you can use these filters to modify images.

### ● Color filters

The color filters include black-and-white filter, sepia filter, monochromatic color filter of 21 colors and mixed color filter of black-and-white + red, black-and-white + green, black-and-white + blue. When you select color filter, the image is displayed on the LCD monitor with the filter effect applied and you can save the modified image.

### ● Illustration filter

You can take a picture like an illustration when you apply the illustration filter.

### ● Soft filter

You can save the image with a soft effect when you apply the soft filter.

### ● Slim filter

You can stretch the image horizontally and vertically.

## Using Digital Filter to Edit Images

- 1 Press the MENU button in the Playback mode.**  
The [▶] Playback] menu appears.
- 2 Use the four-way controller (▲▼) to select [Digital Filter].**
- 3 Press the four-way controller (▶).**
- 4 Use the four-way controller (◀▶) to choose an image to edit.**
- 5 Press the four-way controller (▲▼) to select digital filter.**

The filtered image is displayed on the LCD monitor. The example shows the image filtered with illustration filter.



Go on to “Setting the Monochromatic Filter or Mixed Color Filter”, if you selected the monochromatic filter or mixed color filter. Go on to “Setting the Slim Filter” if you selected the slim filter.

- 6 Press the OK button.**
- 7 Press the four-way controller (▲▼) to select [Save as...] or [Save].**
- 8 Press the OK button and then the MENU button.**

The image is saved with the filter effect applied to the image and the camera is ready to capture or play back images.

### Setting the Monochromatic Filter or Mixed Color Filter

- 6** Press the four-way controller (◀▶) to select the color.
- 7** Press the OK button.
- 8** Press the four-way controller (▲▼) to select [Save as...] or [Save].
- 9** Press the OK button and then the MENU button.

The image is saved with the filter effect applied to the image and the camera is ready to capture or play back images.

### Setting the Slim Filter

- 6** Press the four-way controller (◀▶) to set the slimness.
- 7** Press the OK button.
- 8** Press the four-way controller (▲▼) to select [Save as...] or [Save].
- 9** Press the OK button and then the MENU button.

The image is saved with the filter effect applied to the image and the camera is ready to capture or play back images.



You can display the Digital Filter screen simply by pressing the Fn button. (p.157)



You cannot apply the slim filter on an image captured in the 3D or Panorama Assist modes.

## Memo

# Camera Settings

How to recall the [i Set-up] menu

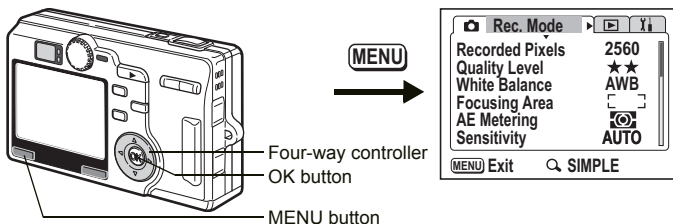

## Formatting an SD Memory Card

Formatting will delete all the data on the SD Memory Card.



- Do not remove the SD Memory Card while the card is being formatted as this may damage the card and render it unusable.
- SD Memory Cards formatted on a PC or device other than the camera cannot be used. Be sure to format the card with the camera.
- Formatting will delete protected data too.

7

Settings

- 1 Select [Format] on the SIMPLE menu or the [i Set-up] menu.**
- 2 Press the four-way controller (▶).**  
The Format screen appears.
- 3 Use the four-way controller (▲) to select [Format].**
- 4 Press the OK button.**

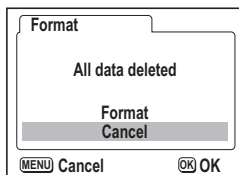

Formatting starts. When formatting is completed, the camera is ready to take pictures.



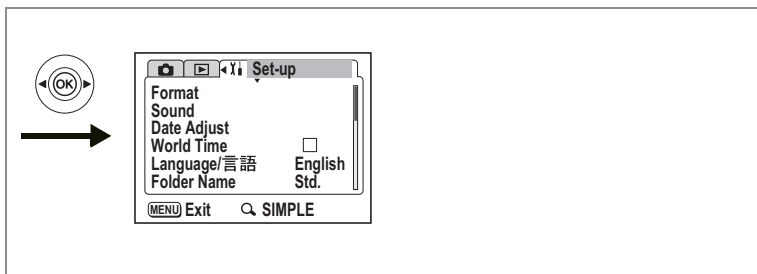

## Adjusting the Brightness of the LCD Monitor

You can adjust the brightness of the LCD monitor.

- 1 Select [Brightness Level] on the [i Set-up] menu.**
- 2 Press the four-way controller (▶).**  
The Brightness Level screen appears.
- 3 Use the four-way controller (◀▶) to adjust the brightness.**  
The monitor gets darker as the bar slider moves to the left and brighter as it moves to the right.
- 4 Press the MENU button.**  
The camera is ready to take or play back images.

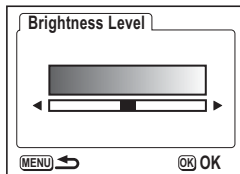

## How to recall the [i Set-up] menu

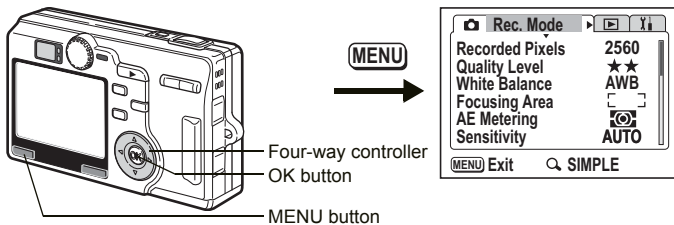

## Changing the Start-up Screen, Background Color and Screen Effects

- 1 Select [Screen Setting] on the [i Set-up] menu.
- 2 Press the four-way controller (▶).  
The Screen Setting screen appears.

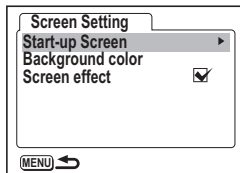

## Changing the Start-up Screen

You can display an image recorded with the camera as the welcome screen when the camera is turned on.

- 3 Use the four-way controller (▲▼) to select [Start-up Screen].
- 4 Press the four-way controller (▶).  
The Change Start-up Screen screen appears.
- 5 Use the four-way controller (◀▶) to select  (On)/ (Off).  
 (On): Displays the start-up screen  
 (Off): Hides the start-up screen
- 6 Press the four-way controller (▼).
- 7 Use the four-way controller (◀▶) to choose an image for the start-up screen.

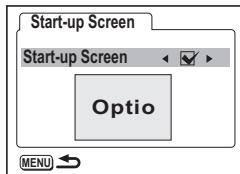

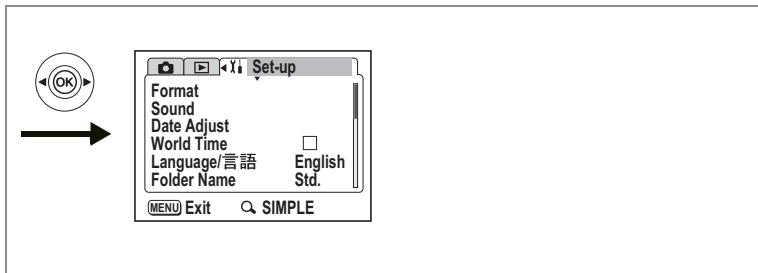

## 8 Press the MENU button three times.

The camera is ready to take or play back images.



- Once the start-up screen has been set, it will not be deleted even if the original image is deleted or the SD Memory Card is formatted. To delete the start-up screen, reset the settings. (p.159)
- You can set any image captured with this camera as the start-up screen.
- The background color cannot be changed for the USER mode and SIMPLE menu.

## Changing the Background Color

You can choose the background design and color of the LCD monitor.

### 3 Use the four-way controller (▲▼) to select [Background Color].

### 4 Press the four-way controller (▶).

Change the Background Color screen appears.

### 5 Use the four-way controller (▲▼◀▶) to choose the background color.

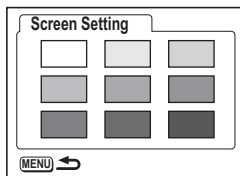

The background color of the menu changes.

### 6 Press the OK button and then the MENU button three times.

The camera is ready to take or play back images.

## How to recall the [i Set-up] menu

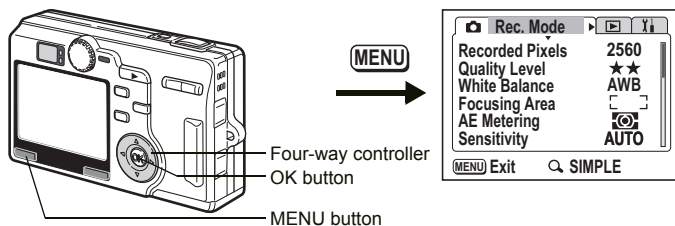

## Using Screen Effects

You can display various animated effects when switching display screens on the LCD monitor.

- 3 Use the four-way controller (▲▼) to select [Screen Effect].**
- 4 Use the four-way controller (◀▶) to select  (On)/  (Off).**
- 5 Press the MENU button twice.**

The camera is ready to take or play back images.

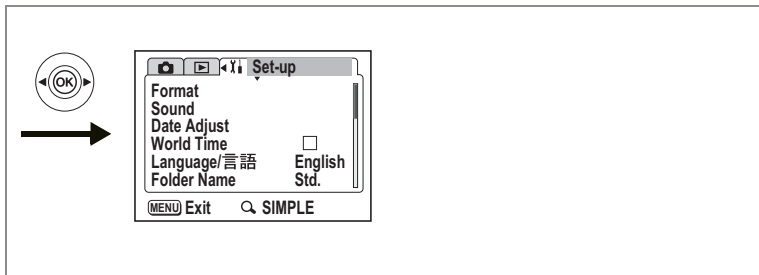

## Changing the Date and Time

You can change the initial date and time settings. You can also set the style in which the date appears on the camera. Choose [mm/dd/yy], [dd/mm/yy] or [yy/mm/dd].

**1 Select [Date Adjust] on the SIMPLE menu or the [Set-up] menu.**

**2 Press the four-way controller (▶).**

The Date Adjust screen appears.

Refer to “Initial Settings” (p.24) for the setting procedure.

## How to recall the [i Set-up] menu

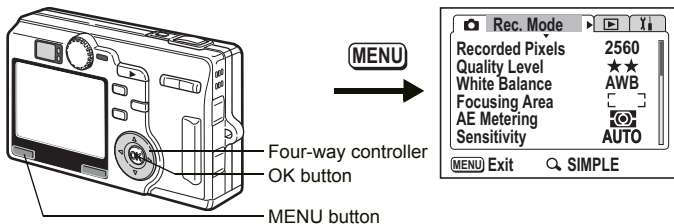

## Changing the Sound Settings

You can adjust the playback volume and the volume of operation sounds, such as the start-up sound, shutter sound, operation sound and self-timer sound. You can also change the operation sounds.

**1 Select [Sound] on the SIMPLE menu or [i Set-up] menu.**

**2 Press the four-way controller (▶).**

The Sound screen appears.

## Changing the Operation Volume and Playback Volume

**3 Use the four-way controller (▲▼) to select [Operation Volume].**

**4 Use the four-way controller (◀▶) to change the volume of sounds.**

**5 Change [Playback Volume] in the same way.**

**6 Press the OK button and then the MENU button.**

The camera is ready to take or play back images.

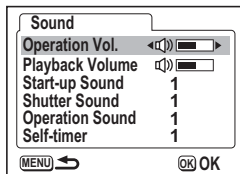

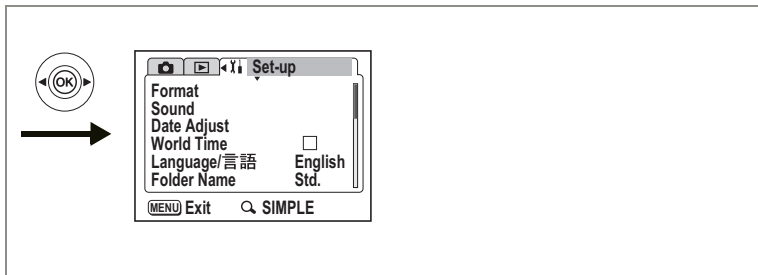

## Changing the Start-up Sound, Shutter Sound, Key Operation Sound, Focus Sound and Self-timer Sound

- 7 Use the four-way controller (▼) to select [Start-up Sound] and press the four-way controller (▶).
- 8 Use the four-way controller (◀▶) to select [1], [2], [3] or [Off] and press the OK button.
- 9 Change the [Shutter Sound], [Operation Sound] and [Self-timer Sound] in the same way.
- 10 Press the OK button and then the MENU button.

The camera is ready to take or play back images.



The Sound settings are saved when the camera is turned off.

## How to recall the [i Set-up] menu

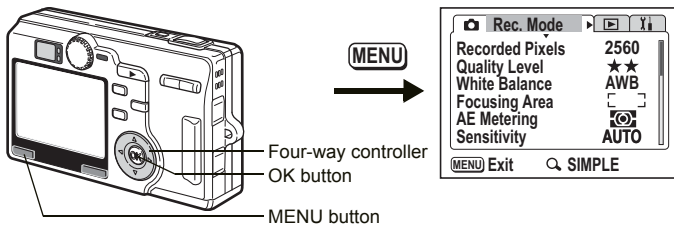

## Setting the World Time

The date and time selected in “Initial Settings” (p.24) serve as the Hometown setting.

You can display the time in a city other than the Home Time city (World Time). This is useful when taking pictures abroad.

**1 Select [World Time] on the [i Set-up] menu.**

**2 Press the four-way controller (▶).**

The World Time screen appears.

**3 Use the four-way controller (◀▶) to select  (On)/ (Off).**

: The time in the city selected in Destination is displayed.

: The time in the city selected in Hometown is displayed.



**4 Press the four-way controller (▼) to select ✈ (Destination) and press the four-way controller (▶).**

The Destination Setting screen appears. The map is selected and ◀▶ appear on the right and left side of the map.

**5 Press the four-way controller (◀▶) to select the region and press the four-way controller (▼).**

**6 Press the four-way controller (◀▶) to select the city and press the four-way controller (▼).**



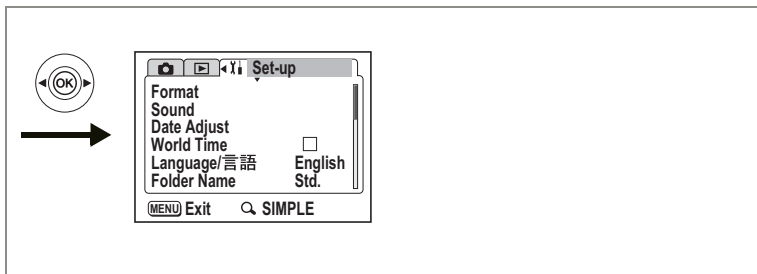

**7 Use the four-way controller (◀▶) to select  (On)/  (Off) of the [DST] and press the OK button.**

The World Time screen appears.

**8 Press the four-way controller (▼) to select (Hometown) and press the four-way controller (▶).**

Repeat Step 5 to 7 to set the region, city, and DST.

**9 Press the MENU button twice.**

The camera is ready to take or play back images with the time in the selected city.



- The default setting of and is [NYC (New York)]. Refer to page 160 for the list of region and city available for the setting.
- The time of the selected city is displayed on the right below of the Destination and Hometown Setting screen.
- The time difference is displayed on the right side of [DST] of the Destination Setting screen.
- The symbols on the map indicate the following information when setting the world time.

Symbol	World Time screen		Destination Setting screen	Hometown Setting screen
	<input checked="" type="checkbox"/> (On)	<input type="checkbox"/> (Off)		
●	Destination (Hometown when  is selected.)	– (Destination when  is selected and Hometown when  is selected.)	Selected city	Selected city
+	Hometown (Destination when  is selected.)	–	–	–
○	–	–	Selectable city	Selectable city

## How to recall the [Yi Set-up] menu

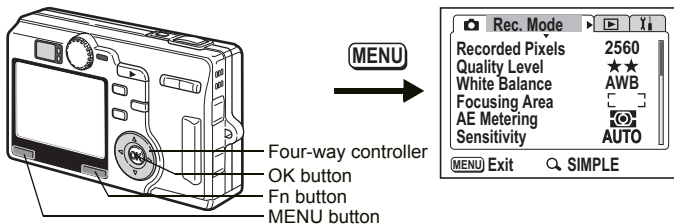

## Changing the Display Language

You can change the language in which the menus, error messages, etc. are displayed.

- 1 Select [Language/言語] on the [Yi Set-up] menu.
- 2 Press the four-way controller (▶).
- 3 Use the four-way controller (▲▼◀▶) to select the language.
- 4 Press the OK button and then the MENU button.

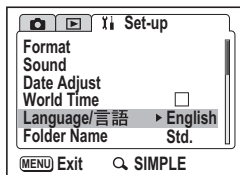

The camera is ready to take or play back images.

## Setting the Folder Name

You can change the way to name the folder to save the images and sounds.

- 1 Select [Folder Name] on the [Yi Set-up] menu.
- 2 Use the four-way controller (▲▼) to change the way to name the folder.

Standard: The folder is numbered from 100 to 999 (Ex: 100PENTX)  
Date: The folder is numbered from 100 to 999 and the date is added after the number. (Ex: 1000425 (when the date is set to April 25<sup>th</sup>))

- 3 Press the OK button and then the MENU button.

The camera is ready to take or play back images.

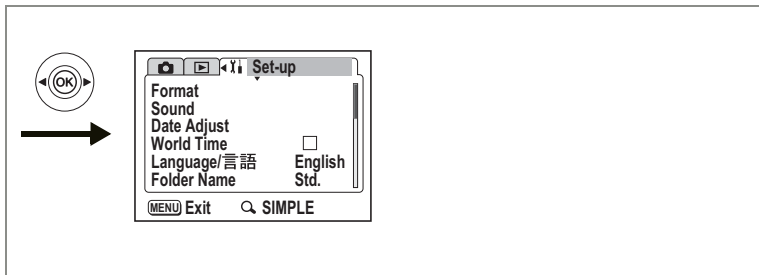

## Changing the Video Output Format

You can select the output format (NTSC or PAL) for taking or playing back images on a TV.

- 1 Select [Video Out] on the [ⓧ⓪ Set-up] menu and press the four-way controller (▶).**
- 2 Use the four-way controller (▲▼) to select [NTSC] or [PAL].**  
Choose the video output format to match the output format of the TV.
- 3 Press the OK button and then the MENU button.**

The camera is ready to take or play back images.



The image is displayed on both the camera and TV regardless of the video output format setting.

## Changing the USB Connection Mode

You can change the USB connection mode depending on whether the USB cable is to be connected to a printer (🖨) or a computer (PC).

- 1 Select [USB Connection Mode] on the [ⓧ⓪ Set-up] menu and press the four-way controller (▶).**
- 2 Use the four-way controller (▲▼) to select [PC] or [🖨].**
- 3 Press the OK button and then the MENU button.**

The camera is ready to be connected to the computer or printer.

## How to recall the [X] Set-up] menu

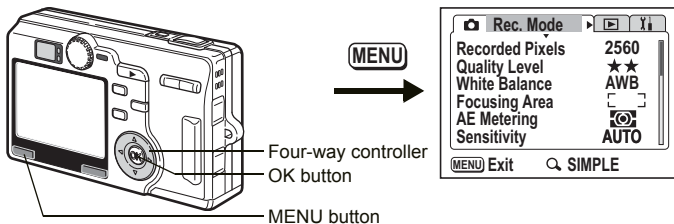

## Sleep Timeout

You can set the LCD monitor to turn off automatically when no operation is performed for a fixed time. The LCD monitor turns on when any operation is performed.

- 1 Select [Sleep Timeout] on the [X] Set-up] menu and press the four-way controller (▶).**
- 2 Use the four-way controller (▲▼) to select [30 sec], [1 min], [2 min] or [Off].**
- 3 Press the OK button and then the MENU button.**

The camera is ready to take or play back images.

7

Settings



This function will not work when playing the slideshow or when the USB cable is connected.

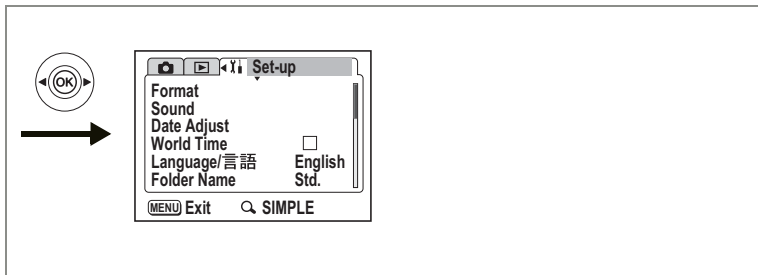

## Setting Auto Power Off

You can set the camera to turn off automatically when no operation is performed for a fixed time.

- 1 Select [Auto Power Off] on the [Set-up] menu and press the four-way controller (▶).**
- 2 Use the four-way controller (▲ ▼) to select [3 min], [5 min] or [Off].**
- 3 Press the OK button and then the MENU button.**

The camera is ready to take or play back images.



The Auto Power Off function will not work when the USB cable is connected.

## How to recall the [Fn Set-up] menu

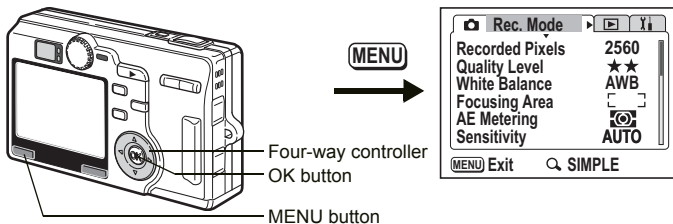

## Registering a Function (Fn Setting)

You can register the function you use most frequently on the four-way controller. The function can be called directly by pressing the four-way controller without displaying the menu.

For the Capture mode (FULL menu display mode), you can register the function of your choice. For the Capture mode (SIMPLE menu display mode) and the Playback mode, the functions are pre-registered.

### Registering a Function in the Capture Mode (FULL menu display)

- 1 Select [Fn Setting] on the [Fn Set-up] menu.**
- 2 Press the four-way controller (▶).**

The Fn Setting screen appears.
- 3 Press the four-way controller (▲▼) to select the key.**
- 4 Press the four-way controller (▶) to display the functions to register.**
- 5 Press the four-way controller (▲▼) to select the functions to register.**
- 6 Press the OK button and then the MENU button twice.**

The selected function is registered and the camera is ready to take pictures.

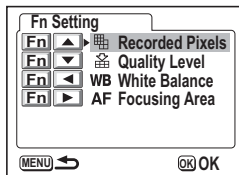

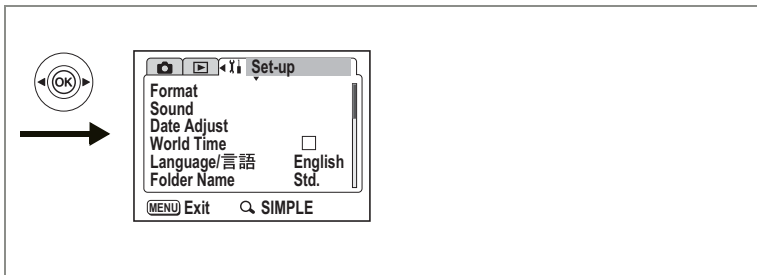

- The functions registered as default setting are as follows. Recorded Pixel for ▲, Quality Levels for ▼, White Balance for ◀, Focusing Area for ▶ are registered as the default Fn Settings.
- Only one function can be registered on each key of the four-way controller.
- You can choose from the following 12 functions: Recorded Pixels, Quality Levels, White Balance, Focusing Area, AE Metering, Sensitivity, Time-lapse Movie, Instant Review, M, Sharpness, Saturation and Contrast.

### Functions Registered in the Capture Mode (SIMPLE menu display) and Playback Mode

Capture mode (SIMPLE menu display)	Image Quality
Playback mode	▲Protect                    ▼DPOF ◀Voice Memo                ▶Digital Filter

### Retrieving a Function

#### 1 Press the Fn button.

**Capture mode (FULL menu display) and Playback mode:**

The functions registered on the four-way controller (▲▼◀▶) are displayed.

**Capture mode (SIMPLE menu display):**

The screen to set the Image Quality is displayed.

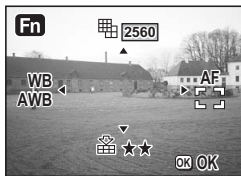

## How to recall the [Fn Set-up] menu

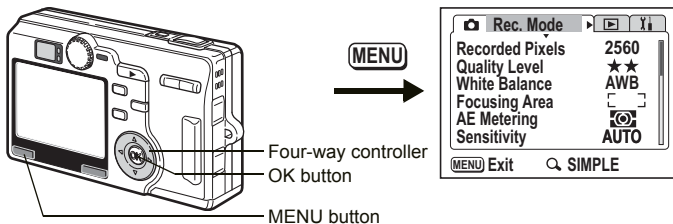

## 2 Press the four-way controller (▲▼◀▶) in the direction for which the function to you want to set is registered.

**To set the function registered on the four-way controller(▲▼):**

Press the four-way controller (◀▶) to change the setting.

**To set the function registered on the four-way controller(◀▶):**

Press the four-way controller (▲▼) to change the setting.

**To set from the Capture mode (SIMPLE menu) display:**

Press the four-way controller (◀▶) to change the setting.

## 3 Press the OK button when the setting of your choice is displayed.



You cannot change the setting in the second or subsequent images in the Panorama Assist and 3D modes.



When using the Fn Setting in the Playback mode, following files some of the functions cannot be selected for the following types of files.

Movie	Digital Filter mode, DPOF and voice memo cannot be selected.
Image with voice memo	Voice memo cannot be selected.
Protected file	[Overwrite] in the Digital Filter mode and voice memo cannot be selected.
3D picture and panoramic photo	The slim filter in the Digital Filter mode cannot be selected.
Damaged file	Fn Setting cannot be selected.



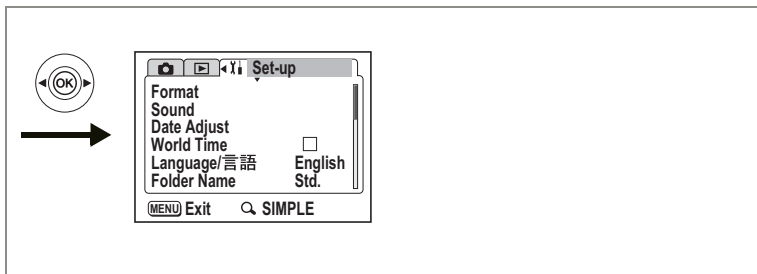

## Resetting to Default Settings

You can return all the settings other than the date and time, language/言語 and world time to the default settings.

- 1 Select [Reset] on the [xi Set-up] menu.**
- 2 Press the four-way controller (▶).**  
The Reset screen appears.
- 3 Use the four-way controller (▲) to select [Reset].**
- 4 Press the OK button.**

The camera is ready to take or play back images.

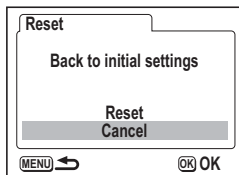

## List of Cities

Refer to the following list of cities when setting the World Time.

Region	City	Region	City
North America	Honolulu		Nairobi
	Anchorage		Jeddah
	Vancouver		Tehran
	San Francisco		Dubai
	Los Angeles		Karachi
	Calgary		Kabul
	Denver		Male
	Chicago		Delhi
	Miami		Colombo
	Toronto		Kathmandu
	New York	Dacca	
	Halifax	East Asia	Rangoon
South America	Mexico City	Bangkok	
	Lima	Kuala Lumpur	
	Santiago	Vientiane	
	Caracas	Singapore	
	Buenos Aires	Phnom Penh	
	Sao Paulo	Ho Chi Minh	
	Rio de Janeiro	Jakarta	
Europe	Madrid	Hong Kong	
	London	Beijing	
	Paris	Shanghai	
	Milan	Manila	
	Rome	Taipei	
	Berlin	Seoul	
	Athens	Tokyo	
	Helsinki	Guam	
	Moscow	Oceania	Perth
	Africa/ West Asia	Dakar	Adelaide
Algiers		Sydney	
Johannesburg		Noumea	
Istanbul		Wellington	
Cairo		Auckland	
Jerusalem		Pago Pago	

# Optional Accessories

A number of dedicated accessories are available for this camera.

**AC adapter D-AC8**

**Battery Charger D-BC8**

**USB cable I-USB17 (\*)**

**AV cable I-AVC7 (\*)**

**Camera case O-CC23**

**Strap O-ST20 (\*) / O-ST24**

**Remote control unit F**

**Remote control unit E (Supporting the Zoom function)**

**Rechargeable lithium-ion battery D-LI8 (\*)**

**Battery charging stand D-BC23 (\*)**

**AC plug cord D-CO2 (\*)**

D-CO2A	Australia	D-CO2B	United Kingdom
D-CO2E	Europe	D-CO2H	Hong Kong
D-CO2J	Japan	D-CO2K	Korea
D-CO2U	North America, Canada		

**3D image viewer O-3DV1**

Products marked with an asterisk (\*) are the same as those supplied with the camera.

# Messages

Messages such as the following may appear on the LCD monitor during camera operation.









Compression error	Compression of the image you captured has failed. Change the quality/size and try again.
No image & sound	There are no images/sound on the SD Memory Card or in the built-in memory.
Memory card full	The SD Memory Card is full and no more images can be saved. Insert a new SD Memory Card or delete unwanted images. (p.21, 118) Change the quality size and try again. (p.134)
Memory card error	Shooting and playback are impossible due to a problem with the SD Memory Card. Try displaying on a PC.
Card not formatted	The SD Memory Card you have inserted is unformatted or has been formatted on a PC or other device and is not compatible with this camera. (p.142)
No card in camera	There is no SD Memory Card in the camera. Turn off the camera and insert the SD Memory Card.
Card locked	The SD Memory Card is write-protected. Only menu operation and mode change are possible.
Data being recorded	The image is being recorded on the SD Memory Card. The protect setting or DPOF settings is being changed. The movie is being recorded.
Camera cannot play back this image or sound	You are trying to play back an image or sound in a format not supported by this camera. You may be able to play it back on another brand of camera or PC.
Deleting	The image is being deleted.
Battery depleted Cannot save image	The battery is exhausted. Recharge the battery or replace with charged battery. (p.14)
Formatting...	The SD Memory Card is being formatted.
Image folder could not be created	The largest file number has been assigned to an image and no more images can be saved. Insert a new SD Memory Card or format the SD Memory Card. (p.142)

Messages such as the following may appear on the LCD monitor when using the PictBridge function.

No paper	There is no paper in the printer.
No ink	There is no ink in the printer.
Printer error	An error message has been sent from the printer.
Data error	A data error message has been sent from the printer.
Jammed	The paper in the printer has jammed.

# Troubleshooting

Problem	Cause	Remedy
Camera will not turn on	Battery is not installed	Check battery is installed. If not, install battery.
	Battery is installed incorrectly	Check orientation of battery. Reinsert battery with (◀) symbol towards back of camera. (p.14)
	Battery power is low	Insert a charged battery or use the AC adapter.
No image on the LCD monitor	LCD monitor is set to OFF	Press DISPLAY button to turn LCD monitor on. (p.82)
	Image is displayed but is hard to see	Image on LCD monitor may be hard to see when taking pictures outside in sunlight.
Shutter will not release	Flash is charging	When flash status lamp blinks red, flash is charging and no pictures can be taken. Lamp lights red when charging is completed.
	No available space on SD Memory Card or in built-in memory	Insert SD Memory Card with available space or delete unwanted images. (p.21, 118)
	Recording	Wait until recording is finished.
Picture is dark	Subject is too far away in a dark environment, such as a night scene	Picture becomes dark if subject is too far away. Take picture within range of flash.
	Background is dark	When taking a picture of a person against a dark background, such as a night scene, the person may appear dark if the flash does not reach the background even with the correct exposure. Set the camera to the  mode to ensure both person and background are clear. (p.81)

Problem	Cause	Remedy
Subject is not in focus	Subject difficult to focus on	Subjects difficult to focus on using autofocus: objects with little contrast (blue sky, white walls, etc.), dark objects, finely patterned objects, fast-moving objects, scenery through window or net, etc. Lock focus on another object located at same distance (press shutter release button halfway), then aim at target and press shutter release button fully, or use the Manual Focus mode.
	Subject is not in focusing area	Position subject in focus frame (focusing area) in middle of LCD monitor. If the subject is outside the focusing area, aim the camera at the subject and lock the focus (press shutter release button halfway), then compose picture and press the shutter release button fully.
	Subject is too close	Set the focus mode to  or  . (p.85)
	The focus mode is set to  or  .	Normal pictures will be out of focus if taken with the focus mode set to  or  .
Flash does not discharge	Flash mode is set to Off	Set to Auto or  . (p.84)
	The capture mode is set to  , Continuous Shooting or Super Macro mode	Flash will not discharge in these modes.

# Main Specifications

## Camera

Type	Fully automatic compact digital still camera with built-in zoom lens	
Effective Pixels	5.0 megapixels	
Sensor	5.36 megapixels (total pixels), 1/2.5-inch interline transfer CCD with a primary color filter	
Recorded Pixels	Still Picture	2560×1920 pixels, 2048×1536 pixels, 1600×1200 pixels 1024×768 pixels, 640×480 pixels
	Movie	320×240 pixels
Sensitivity	Auto, manual (50, 100, 200, 400: Standard output sensitivity)	
File Format	Still Picture	JPEG (Exif2.2), DCF, DPOF, PRINT Image Matching III
	Movie	AVI (Open DML Motion JPEG), streaming recording, approx. 30 fps, with sound
	Sound	WAV (ADPCM system), monaural, max. recording time 262 min. (when using a 64 MB SD Memory Card)
Quality Level	Best, Better, Good	
Storage Medium	SD Memory Card	

### Image Storage Capacity (When using a 64 MB SD Memory Card)

Quality Level Recorded Pixels	Best ★★★	Better ★★	Good ★	Movie (320×240)
2560×1920	Approx. 42	Approx. 66	Approx. 93	Approx. 158 sec.
2048×1536	Approx. 61	Approx. 95	Approx. 132	
1600×1200	Approx. 81	Approx. 127	Approx. 174	
1024×768	Approx. 132	Approx. 202	Approx. 274	
640×480	Approx. 192	Approx. 295	Approx. 349	

White Balance	Auto, Daylight, Shade, Tungsten Light, Fluorescent Light, Manual	
Lens	Focal Length	5.8 mm – 29 mm (equivalent to 36 mm - 180 mm in 35 mm format)
	Maximum Aperture	f/2.8 – f/4.7
	Lens Composition	10 elements in 8 groups (two single-faced aspherical lenses)
	Zoom Type	Electrically driven
	Picture Range	32.5 mm × 43.4 mm (screen is filled) (Super Macro mode)
	Lens Barrier	Electrically driven
Digital Zoom	Capture/Playback Mode	Approx. max 4× (combines with 5× optical zoom to give zoom magnification equivalent to 20×)
Viewfinder	Type	Real-image optical zoom viewfinder
	Magnification	Wide 0.37×, Tele 1.55×
LCD Monitor	1.8-inch TFT color LCD with approx. 118 kilopixels monitor (with backlight), frame coverage approx. 100%	



Playback Functions	Single-frame, 9-frame index, enlargement (max. 4×), scroll, rotating, sound, slideshow, movie playback, histogram display, trimming, resizing	
	Digital Filter	Black-and-White, Sepia, 21 Color, Black-and-White + Red, Black-and-White + Green, Black-and-White + Blue, Illustration, Slim, Soft
Focusing System	Type	TTL contrast detection system by sensor 5-point autofocus (multi/spot autofocus possible)
	Focusing Range (from lens front)	Normal: 0.6 m – ∞ (full zoom range) Macro: 0.12 m – 0.7 m (from wide angle position to approx. ×2.24 optical zoom) Super Macro: 0.03 m – 0.14 m (wide zoom position only) Focus Limit OFF: 0.12 m – ∞ (full zoom range) Landscape: ∞ (full zoom range)
	Focus Lock	By half-pressing shutter release button
	Manual Focus	0.03 m – ∞ (Wide zoom position) 0.6 m – ∞ (Tele zoom position)
Exposure Mechanism	AE Metering	TTL metering by sensor (multi-segment, center-weighted, spot)
	Exposure Modes	Manual, Shutter Priority, Aperture Priority, Program, and Picture Modes
	EV Compensation	±2 EV (can be set in 1/3 EV steps)
	Auto Bracket	EV Compensation, White Balance, Sharpness, Saturation, Contrast
Capture Modes	Program, Picture, Night-Scene, Movie, Voice Recording, USER, Manual	
	Picture Modes	Landscape, Flower, Portrait, Self-Portrait, Sports, Surf & Snow, Autumn Colors, Sunset, Museum, Food, 3D, Panoramic Assist
Movie	Recording Time	From approx. 1 sec. until the memory card is full
	Time-lapse Movie	Frame rate ×2, ×5, ×10, ×20
Shutter	Type	Electronic/mechanical shutter
	Speed	f/2.8 – f/5.0 (not including f/5.0) Approx. 1/1000 sec. – 4sec. f/5.0 – f/8.0 (including f/5.0) Approx. 1/2000 sec. – 4 sec. (1/1000 sec. or longer in the Manual Exposure, Shutter-Priority and Aperture-Priority modes. Noise Reduction activates when longer than 1/4 sec.)
Flash	Type	Auto flash with red-eye reduction function
	Flash Modes	Auto, Flash Off, Flash On, Auto + Red-eye Reduction, Flash On + Red-eye Reduction
	Light Compensation	±2 EV (can be set in 1/3 EV steps)
	Working Range	Wide: approx. 0.12 m – 4.2 m (5.8 mm, at standard output sensitivity 200) Tele: approx. 0.6 m – 2.5 m (29 mm, at standard output sensitivity 200)
Drive Modes	Single-frame, Continuous, 3-sec. Remote Control, Instant Remote Control, 10-sec. Self-timer. 2-sec. Self-timer, Auto Bracket, Interval	
Time Function	World Time setting for 68 cities (28 time zones)	
Power Supply	Rechargeable lithium-ion battery D-LI8, AC adapter (optional)	
Battery Life	Approx. 100 images	(at 23°C with LCD monitor on, flash fired for 50% of shots and using a rechargeable lithium ion battery D-LI8) * In accordance with CIPA standard.

Max. Charging Time	Approx. 100 min.	
In/Out Port	High speed USB 2.0 /AV terminal, external power supply terminal	
Video Output Format	NTSC, PAL (monaural sound)	
PictBridge	Type of Printer	PictBridge supported
	Printing Modes	All Image Printing, Single Image Printing, DPOF Printing, Paper Size Setting
Size	91.5 (W) × 56 (H) × 28 (D) mm (excluding operating members and projections)	
Weight	150 g (excluding battery and SD Memory Card)	
Weight When Shooting	165 g (including battery and SD Memory Card)	
Accessories	Rechargeable lithium-ion battery, Battery charging stand, AC plug cord, USB cable, software (CD-ROM), AV cable, strap, operating manual	
Language	English, Japanese, French, German, Spanish, Italian, Russian, Korean, Chinese (Traditional, Simplified)	

## Power Supply

	Battery Charging Stand D-BC23	AC Adapter D-AC8 (optional)
Rated input	AC100-240V (50Hz/60Hz)	AC100-240V (50Hz/60Hz)
Rated output	DC 4.2 V / 630 mA	DC 4.5 V/2 A
External dimensions	99.5 × 85 × 25 (mm)	90 × 43.5 × 26.5 (mm)
Weight	100 g	122 g

# WARRANTY POLICY

All PENTAX cameras purchased through authorized bona fide photographic distribution channels are guaranteed against defects of material or workmanship for a period of twelve months from date of purchase. Service will be rendered, and defective parts will be replaced without cost to you within that period, provided the equipment does not show evidence of impact, sand or liquid damage, mishandling, tampering, battery or chemical corrosion, operation contrary to operating instructions, or modification by an unauthorized repair shop. The manufacturer or its authorized representatives shall not be liable for any repair or alterations except those made with its written consent and shall not be liable for damages from delay or loss of use or from other indirect or consequential damages of any kind, whether caused by defective material or workmanship or otherwise; and it is expressly agreed that the liability of the manufacturer or its representatives under all guarantees or warranties, whether expressed or implied, is strictly limited to the replacement of parts as hereinbefore provided. No refunds will be made on repairs by non-authorized PENTAX service facilities.

## Procedure During 12-month Warranty Period

Any PENTAX which proves defective during the 12-month warranty period should be returned to the dealer from whom you purchased the equipment or to the manufacturer. If there is no representative of the manufacturer in your country, send the equipment to the manufacturer, with postage prepaid. In this case, it will take a considerable length of time before the equipment can be returned to you owing to the complicated customs procedures required. If the equipment is covered by warranty, repairs will be made and parts replaced free of charge, and the equipment will be returned to you upon completion of servicing. If the equipment is not covered by warranty, regular charges of the manufacturer or of its representatives will apply. Shipping charges are to be borne by the owner. If your PENTAX was purchased outside of the country where you wish to have it serviced during the warranty period, regular handling and servicing fees may be charged by the manufacturer's representatives in that country. Notwithstanding this, your PENTAX returned to the manufacturer will be serviced free of charge according to this procedure and warranty policy. In any case, however, shipping charges and customs clearance fees to be borne by the sender. To prove the date of your purchase when required, please keep the receipt or bills covering the purchase of your equipment for at least a year. Before sending your equipment for servicing, please make sure that you are sending it to the manufacturer's authorized representatives or their approved repair shops, unless you are sending it directly to the manufacturer. Always obtain a quotation for the service charge, and only after you accept the quoted service charge, instruct the service station to proceed with the servicing.

- This warranty policy does not affect the customer's statutory rights.
- The local warranty policies available from PENTAX distributors in some countries can supersede this warranty policy. Therefore, we recommend that you review the warranty card supplied with your product at the time of purchase, or contact the PENTAX distributor in your country for more information and to receive a copy of the warranty policy.



The CE Mark is a Directive conformity mark of the European Community.

## **For customers in USA**

### **STATEMENT OF FCC COMPLIANCE**

This device complies with Part 15 of the FCC Rules. Operation is subject to the following two conditions: (1) This device may not cause harmful interference, and (2) this device must accept any interference received, including interference that may cause undesired operation.

Changes or modifications not approved by the party responsible for compliance could void the user's authority to operate the equipment.

This equipment has been tested and found to comply with the limits for a Class B digital device, pursuant to part 15 of the FCC Rules.

These limits are designed to provide reasonable protection against harmful interference in a residential installation. This equipment generates, uses and can radiate frequency energy and, if not installed and used in accordance with the instructions, may cause harmful interference to radio communications. However, there is no guarantee that interference will not occur in a particular installation.

If this equipment does cause harmful interference to radio or television reception, which can be determined by turning the equipment off and on, the user is encouraged to try to correct the interference by one or more of the following measures:

- Reorient or relocate the receiving antenna.
  - Increase the separation between the equipment and receiver.
  - Connect the equipment into an outlet on a circuit different from that to which the receiver is connected.
- \* Consult the dealer or an experienced radio/TV technician for help.

## **For customers in Canada**

This Class B digital apparatus meets all requirements of the Canadian Interference - Causing Equipment Regulations.

## **Pour les utilisateurs au Canada**

Cet appareil numérique de la classe B respecte toutes les exigences du Règlement sur le matériel brouilleur du Canada.

# Declaration of Conformity

According to 47CFR, Parts 2 and 15 for  
Class B Personal Computers and Peripherals

We: PENTAX Imaging Company  
A Division of PENTAX of America, Inc.

Located at: 600 12<sup>th</sup> Street, Suite 300  
Golden, Colorado 80401 U.S.A.  
Phone: 303-799-8000 FAX: 303-790-1131

Declare under sole responsibility that the product identified herein, complies with 47CFR Parts 2 and 15 of the FCC rules as a Class B digital device. Each product marketed is identical to the representative unit tested and found to be compliant with the standards. Records maintained continue to reflect the equipment being produced can be expected to be within the variation accepted, due to quantity production and testing on the statistical basis as required by 47CFR §2.909. Operation is subject to the following two conditions: (1) This device may not cause harmful interference, and (2) This device must accept any interference received, including interference that may cause undesired operation. The above named party is responsible for ensuring that the equipment complies with the standards of 47CFR §15.101 to §15.109.

Product Name: PENTAX Digital Still Camera

Model Number: Optio SV

Contact person: Customer Service Manager

Date and Place: September, 2004, Colorado

## Numerics

- 3D Image Mode ..... 60
- 3D Image Viewer ..... 63

## A

- AC adapter ..... 19, 124
- Aperture-Priority Mode ..... 52
- Auto Bracket ..... 74
- Auto Power Off ..... 155
- Autofocus ..... 85
- AV cable ..... 124

## B

- Background Color ..... 145
- Battery ..... 14
- Battery charging stand ..... 15
- Battery charging stand terminal ..... 11
- Battery Level Indicator ..... 17
- Battery/Card cover ..... 11
- Best ..... 23, 90
- Better ..... 23, 90

## C

- Capture Mode ..... 81
- Charging the Battery ..... 15
- Continuous Shooting Mode ..... 71
- Contrast ..... 102

## D

- Date/Time ..... 25, 147
- DC input terminal ..... 11
- Delete button ..... 12, 36
- Delete Images ..... 118
- Delete the Displayed Image ..... 30
- Deleting All Images ..... 121
- Deleting Selected Images ..... 120
- Digital Filter ..... 138
- Digital Zoom ..... 69
- DPOF ..... 125
- Drive mode button ..... 12, 35

## E

- Editing ..... 134
- EV Compensation ..... 103

## F

- Flash ..... 11
- Flash button ..... 12, 34
- Flash Mode ..... 84
- Flash status lamp ..... 11

- Fn button ..... 12, 35, 36
- Fn Setting ..... 156
- Focus button ..... 12, 34
- Focus frame ..... 28
- Focus Limit ..... 97
- Focus Mode ..... 85
- Focus status lamp ..... 11
- Focusing Area ..... 85, 94
- Folder ..... 152
- Format ..... 142
- Four-way controller ..... 12, 35, 36, 37
- FULL Menu ..... 38, 41

## G

- Good ..... 23, 90
- Guide Indications ..... 12

## H

- Hometown ..... 150

## I

- Image Quality ..... 91
- Image Size ..... 23, 134
- Infinity-Landscape ..... 85
- Initial Settings ..... 24
- Instant Review ..... 28, 99
- Interval Shooting ..... 76

## L

- Language ..... 24, 152
- LCD Brightness ..... 143
- LCD monitor ..... 11
- Lens ..... 11
- Light Metering Range ..... 95

## M

- Macro ..... 85
- Manual Exposure Mode ..... 49
- Manual Focus ..... 85
- Memory ..... 104
- MENU button ..... 12, 35, 36, 37
- Messages ..... 162
- Microphone ..... 11
- Mode dial ..... 11, 12, 27
- Movie Mode ..... 56

## N

- Night-Scene Mode ..... 55
- Nine Image Display ..... 115
- Noise Reduction ..... 98

Number of Recordable Images .....	23
Number of recordable images .....	17

## O

OK button .....	12, 35, 36, 37
Operation sound .....	148
Optional Accessories .....	161

## P

Panorama .....	66
Panorama Assist Mode .....	66
Paper Size .....	132
PictBridge .....	129
Picture Mode .....	58
Playback button .....	12, 34, 36, 37
Playback Menu .....	42
Playback Mode .....	81
Playback time .....	17
Playing Back Movies .....	113
Playing Back Sounds .....	109
Playing Back Still Pictures .....	29
Playing Back the Previous or Next Image .....	29
Power switch .....	11, 12, 32
Press down fully (Shutter release button) .....	28
Press halfway (Shutter release button) .....	28
Printer .....	129
Printing Service .....	125
Program Mode .....	48
Protect .....	122

## Q

Quality .....	23, 134
Quality Level .....	90
Quick Delete .....	119
Quick Zoom .....	112

## R

Rec.Mode Menu .....	41
Recorded Pixels .....	88
Recording Sound .....	108
Remote control receiver .....	11
Remote Control Unit .....	72
Reset .....	159
Rotate .....	30

## S

Saturation .....	101
Screen Effect .....	146
SD Memory Card .....	21, 22, 142
Self-Timer .....	70

Self-timer lamp .....	11
Self-timer sound .....	148
Sensitivity .....	96
Set-up Menu .....	42
Sharpness .....	100
Shooting Conditions .....	74
Shooting Information .....	82, 114
Shutter release button .....	11, 12, 28, 34, 36, 37
Shutter sound .....	148
Shutter-Priority Mode .....	51
SIMPLE Menu .....	44, 47
Sleep Timeout .....	154
Slideshow .....	116
Sound .....	148
Speaker .....	11
Start-up Screen .....	144
Start-up sound .....	148
Status lamps .....	28
Strap .....	13
Strap lug .....	11
Super Macro .....	85

## T

Taking Movies .....	56
Taking Still Pictures .....	27
Tele .....	68
Terminal cover .....	11
Time-lapse Movies .....	79
Trimming .....	136
Tripod socket .....	11
TV .....	124

## U

USB cable .....	129
USB Connection Mode .....	153
USB/AV terminal .....	11
User Mode .....	54

## V

Video Output Format .....	153
Viewfinder .....	11
Viewing Mode .....	62
Voice Memo .....	110
Voice Recording Mode .....	108

## W

White Balance .....	92
Wide .....	68
World Time .....	150, 160
Write-protect switch .....	22



## Z

Zoom .....	68
Zoom button .....	12, 34, 36
Zoom Display .....	111

# Memo

# Memo

- PENTAX Corporation** 2-36-9, Maeno-cho, Itabashi-ku, Tokyo 174-8639, JAPAN  
(<http://www.pentax.co.jp/>)
- PENTAX Europe GmbH  
(European Headquarters)** Julius-Vosseler-Strasse, 104, 22527 Hamburg, GERMANY  
(HQ - <http://www.pentaxeurope.com>)  
(Germany - <http://www.pentax.de>)
- PENTAX U.K. Limited** PENTAX House, Heron Drive, Langley, Slough, Berks  
SL3 8PN, U.K.  
(<http://www.pentax.co.uk>)
- PENTAX France S.A.S.** 12/14, rue Jean Poulmarch, 95106 Argenteuil Cedex, FRANCE
- PENTAX Benelux B.V.** (for Netherlands)  
Spinveld 25, 4815 HR Breda, NETHERLANDS  
(<http://www.pentax.nl>)  
(for Belgium & Luxembourg)  
Weiveldlaan 3-5, 1930 Zaventem, BELGIUM  
(<http://www.pentax.be>)
- PENTAX (Schweiz) AG** Widenholzstrasse 1 Postfach 367 8305 Dietlikon, SWITZERLAND  
(<http://www.pentax.ch>)
- PENTAX Scandinavia AB** P.O. Box 650, 75127 Uppsala, SWEDEN  
(<http://www.pentax.se>)
- PENTAX Imaging Company**  
**A Division of PENTAX of America, Inc.**  
(Headquarters)  
600 12<sup>th</sup> Street, Suite 300 Golden Colorado 80401, U.S.A.  
(Distribution & Service Center)  
16163 West 45th Drive, Unit H Golden, Colorado  
80403, U.S.A. (<http://www.pentaximaging.com>)
- PENTAX Canada Inc.** 1770 Argenta Road Mississauga, Ontario L5N 3S7, CANADA  
(<http://www.pentaxcanada.ca>)



for your  
precious moments

<http://www.digital.pentax.co.jp>

- Specifications and external dimensions are subject to change without notice.