

**PENTAX Corporation** 2-36-9, Maeno-cho, Itabashi-ku, Tokyo 174-8639, JAPAN  
(<http://www.pentax.co.jp/>)

**PENTAX Europe GmbH (European Headquarters)**  
Julius-Vosseler-Strasse, 104, 22527 Hamburg, GERMANY  
(HQ - <http://www.pentaxeuropa.com>)  
(Germany - <http://www.pentax.de>)

**PENTAX U.K. Limited** PENTAX House, Heron Drive, Langley, Slough, Berks  
SL3 8PN, U.K.  
(<http://www.pentax.co.uk>)

**PENTAX France S.A.S.** 12/14, rue Jean Poulmarch, 95106 Argenteuil Cedex, FRANCE

**PENTAX Benelux B.V.** (for Netherlands)  
Spinveld 25, 4815 HR Breda, NETHERLANDS  
(<http://www.pentax.nl>)  
(for Belgium & Luxembourg)  
Weiveldlaan 3-5, 1930 Zaventem, BELGIUM  
(<http://www.pentax.be>)

**PENTAX (Schweiz) AG** Widenholzstrasse 1 Postfach 367 8305 Dietlikon, SWITZERLAND  
(<http://www.pentax.ch>)

**PENTAX Scandinavia AB** P.O. Box 650, 75127 Uppsala, SWEDEN  
(<http://www.pentax.se>)

**PENTAX U.S.A., Inc** 600 12<sup>th</sup> Street, Suite 300  
Golden, Colorado 80401, U.S.A.  
(<http://www.pentax.com>)

**PENTAX Canada Inc.** 1770 Argentia Road Mississauga, Ontario L5N 3S7,  
CANADA  
(<http://www.pentaxcanada.ca>)



- Printed on recycled paper
- Specifications and external dimensions are subject to change without notice.

57343

Copyright © PENTAX Corporation 2004  
01-200402 Printed in Japan

# PENTAX™

Optio S4i

Digital Camera

## Optio S4i

### Operating Manual

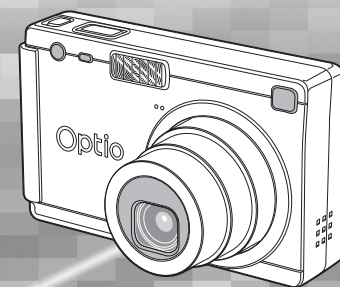

To ensure the best performance from  
your camera, please read the Operating  
Manual before using the camera.

Thank you for buying the PENTAX Optio S4i Digital Camera. Please read this manual before using the camera in order to get the most out of all the features and functions. Keep this manual safe, as it can be a valuable tool in helping you to understand all the camera's capabilities.

### **Regarding copyrights**

Images taken using the Optio S4i that are for anything other than personal enjoyment cannot be used without permission according to the rights as specified in the Copyright Act. Please take care, as there are even cases where limitations are placed on taking pictures even for personal enjoyment during demonstrations, industrial enterprise or as items for display. Images taken with the purpose of obtaining copyrights also cannot be used outside the scope of use of the copyright as laid out in the Copyright Act, and care should be taken here also.

### **To users of this camera**

- There is a possibility that recorded data may be erased or that the camera may not function correctly when used in surroundings such as installations generating strong electromagnetic radiation or magnetic fields.
- The liquid crystal panel used in the LCD display is manufactured using extremely high precision technology. Although the level of functioning pixels is 99.99% or better, you should be aware that 0.01% or fewer of the pixels may not illuminate or may illuminate when they should not. However, this has no effect on the recorded image.

### **Regarding trademarks**

- The SD logo  is a trademark.
- PENTAX is a trademark of PENTAX Corporation.
- Optio is a trademark of PENTAX Corporation.
- All other brands or product names are trademarks or registered trademarks of their respective companies.
- The USB driver uses software developed by inSilicon Corporation. Copyright © 2002 inSilicon Corporation. All rights reserved.
- This product supports PRINT Image Matching II. When used in combination, PRINT Image Matching II enables digital still cameras, printers and software help photographers to produce images more faithful to their intentions. Copyright 2001 Seiko Epson Corporation. All Rights Reserved. PRINT Image Matching II is a trademark of Seiko Epson Corporation.
- "PictBridge" allows the user to connect the printer and digital camera directly, using the unified standard for the direct printout of images. You can print images directly from the camera through a few simple operations.
- There is a possibility that the illustrations and the display screen of the LCD monitor in this manual are different from the actual product.

## FOR SAFE USE OF YOUR CAMERA

Sufficient attention has been paid to the safety of this product but please pay particular attention to the warnings indicated by the following symbols during use.



### **Warning**

These symbols indicate that it is possible that the user may experience serious difficulties if the warnings are not heeded.



### **Caution**

These symbols indicate that it is possible that the user may experience minor or middling difficulties or physical difficulties if the warnings are not heeded.

## About the Camera



### **Warning**

- Do not attempt to take the camera apart or remodel the camera. High voltages are present within the camera, and there is therefore a danger of electric shocks.
- If the inside of the camera should become exposed as a result of, for example, the camera being dropped, please do not under any circumstances touch such exposed portions, as there is a danger of receiving an electric shock.
- Wrapping the strap of the camera around your neck is also dangerous. Please take care that small children do not hang the strap around their necks.
- To avoid the risk of it being swallowed by mistake, keep the SD Memory Card out of the reach of small children. Seek medical attention immediately if accidentally swallowed.
- Use an AC adapter that is of the power and voltage specified for exclusive use with this product. The use of an AC adapter other than that specified exclusively for use with this product may cause fire or electric shocks.
- If the camera emits smoke or a strange smell, or in the event of any other irregularity, stop using the camera immediately, remove the battery or disconnect the AC adapter and contact your nearest PENTAX service center. Continued use of the camera may result in fire or electric shock.

### **Caution**

- Never try to disassemble or short the battery. Also, do not dispose of the battery in fire, as it may explode.
- Remove the battery from the camera immediately if it becomes hot or begins to smoke. Be careful not to burn yourself during removal.
- Some portions of the camera heat up during use, so please take care, as there is a risk of low temperature burns if such portions are held for long periods of time.
- Do not place your finger on the flash when it is discharging as there is a risk of burns.
- Do not discharge the flash while it is touching your clothing as there is a risk of discoloring.
- If any of the battery leakage should come in contact with your eyes, do not rub them. Flush your eyes with clean water and get medical attention immediately.
- If any of the battery leakage should come in contact with skin or clothes, wash the affected areas thoroughly with water.

### **About the Battery Charger D-BC8 and the AC Adapter D-AC8**

### **Warning**

- Do not use the product at a voltage other than the specified voltage. Use with a power source or voltage other than that designed can cause a fire or electrical shock. The specified voltage is 100-240 V AC.
- Do not disassemble or modify the product. This can cause a fire or electrical shock.
- If the generation of smoke or strange odor from the product or other abnormality occurs, immediately discontinue using and consult a PENTAX Service Center. Continuing to use the product can cause a fire or electrical shock.
- If water should happen to get inside the product, consult a PENTAX Service Center. Continuing to use the product can cause a fire or electrical shock.
- If lightning should be present during using, unplug the power cord and discontinue using. Continuing to use the product can cause damage to the equipment, fire or electrical shock.
- Wipe off the plug of the power cord if it should become covered with dust. This can cause a fire.

 **Caution**

- Do not place heavy objects on the AC plug cord, allow heavy objects to drop onto it or allow the AC plug cord to become damaged due to excessive bending. If the AC plug cord becomes damaged, consult a PENTAX Service Center.
- Do not short or touch the output terminals of the product while it is still plugged in.
- Remove the battery and unplug the AC plug cord when not using the battery charger.
- Do not plug in the AC plug cord with wet hands. This can cause an electrical shock.
- Do not subject the product to strong impacts or allow it to drop onto a hard surface. This can cause a malfunction.
- To reduce the risk of hazards, use only CSA/UL Certified power supply cord set, cord is Type SPT-2 or heavier, minimum NO.18 AWG copper, one end with a molded-on male attachment plug cap (with a specified NEMA configuration), and the other is provided with a molded-on female connector body (with a specified IEC nonindustrial type configuration) or the equivalent.
- Do not use the battery charger to charge batteries other than the ones specified. This can cause overheating or malfunctions.

## Care to be Taken During Handling

- Take the international warranty card with you when you travel abroad. Also take the Worldwide Service Network that is included in the package. This will be useful if you experience problems abroad.
- When the camera has not been used for a long time, confirm that it is still working properly, particularly prior to taking important pictures (such as at a wedding or during travelling). PENTAX is not responsible for consequential damages (costs incurred as a result of taking pictures, loss of benefits that were to be obtained through taking pictures) arising from failure of this product.
- The lens on this camera is not exchangeable. The lens is not removable.
- Do not clean the product with organic solvents such as thinner or alcohol benzene.
- Places of high temperature and humidity should be avoided. Particular care should be taken regarding vehicles, which can become very hot inside.
- Storing the camera where pesticides and chemicals are handled should be avoided. Remove from case and store in a well-ventilated place to prevent the camera from becoming moldy during storage.
- Do not use the camera where it may come in contact with rain, water or any other liquid, because the camera is not weather, water, or liquid resistant. Should the camera get wet from rain, splashing water, or any other liquid, wipe it off immediately with a dry soft cloth.
- Ensure that the camera is not subjected to substantial vibrations, shocks or pressure. Place the camera on a cushion for protection when the camera is subjected to the vibrations of a motorbike, car, or ship, etc.
- The temperature range in which the camera can be used is 0°C to 40°C (32°F to 104°F).
- The liquid crystal display will become black at temperatures of approximately 60°C (140°F) but will return to normal when normal temperatures are returned to.
- The response speed of the liquid crystal display becomes slow at low temperatures. This is due to the properties of the liquid crystal and is not a fault.
- Periodic checks are recommended every 1 to 2 years in order to maintain high-performance.

- If the camera is subjected to rapid temperature changes, condensation may form on the inside and outside of the camera.  
Therefore put the camera in a bag or plastic bag, and take the camera out when the difference in temperature has subsided.
- Avoid contact with garbage, dirt, sand, dust, water, toxic gases, salt, etc. as this may cause damage to the camera. If rain or drops of water get onto the camera, please wipe dry.
- Refer to “Precautions when using an SD Memory Card” (p.21) regarding the SD Memory Card.
- Please do not press forcefully on the LCD monitor. This could cause breakage or malfunction.
- Be careful not to sit down with the camera in your back pocket as this may damage the exterior of the camera or the LCD monitor.
- When using a tripod with the camera, be careful not to overtighten the screw in the tripod socket on the camera.

# Contents

FOR SAFE USE OF YOUR CAMERA .....	1
Care to be Taken During Handling .....	4
Contents .....	6
Contents of the Operating Manual .....	9
Checking the Contents of the Package .....	10
Names of Parts .....	11
Names of Operating Parts .....	12
<b>Getting Started</b> .....	<b>13</b>
<b>Attaching the Strap</b> .....	<b>13</b>
<b>Powering the Camera</b> .....	<b>14</b>
Installing the Battery .....	14
Removing the Battery .....	14
Charging the Battery .....	15
Using the AC Adapter (optional) .....	18
<b>Installing the SD Memory Card</b> .....	<b>20</b>
Image Size and Quality .....	22
<b>Initial Settings</b> .....	<b>23</b>
Setting the Display Language .....	23
Setting the Date and Time .....	24
<b>Quick Start</b> .....	<b>26</b>
<b>Taking Still Pictures</b> .....	<b>26</b>
<b>Playing Back Still Pictures</b> .....	<b>28</b>
Playing Back an Image .....	28
Playing Back the Previous or Next Image .....	28
Rotating the Displayed Image .....	29
<b>Common Operations</b> .....	<b>30</b>
<b>Turning the Camera On and Off</b> .....	<b>30</b>
Lens Closed Playback Mode .....	31
Voice Recording Mode .....	31
<b>Using the Button Functions</b> .....	<b>32</b>
Capture Mode .....	32
Playback Mode .....	34
Voice Recording Mode .....	35
<b>Setting the Menus</b> .....	<b>36</b>
How to Set the Menus .....	36
Menu List .....	38
<b>Taking Pictures</b> .....	<b>40</b>
<b>Taking Pictures</b> .....	<b>40</b>
Taking Pictures by the Simplest Procedure (Green Mode) .....	40
Setting the Functions (Program Mode) .....	41
Selecting the Picture Mode According to the Shooting Scene (Picture Mode) .....	42



Taking Pictures of Dark Scenes (Night-Scene Mode).....	43
Taking Moving Pictures (Moving Picture Mode).....	44
Taking Panorama Pictures (Panorama Assist Mode).....	46
Taking Soft-Contoured Pictures (Soft Focus Mode).....	48
Taking Posterization-Type Pictures (Posterization Mode).....	49
Taking Pictures with Digital Filters (Digital Filter Mode).....	50
Using Preset Function Settings (User Mode).....	52
Taking Underwater Pictures (Marine Mode).....	53
Taking 3D Pictures (3D Image Mode).....	55
Using the Self-Timer.....	60
Using the Remote Control Unit (optional).....	61
Continuous Shooting (Continuous Shooting Mode).....	62
Using the Zoom.....	63
Taking Time-Lapse Moving Pictures.....	65
<b>Setting the Shooting Functions.....</b>	<b>66</b>
Changing the Mode.....	66
Selecting the Capture Mode.....	66
Displaying Shooting Information in Capture Mode.....	68
Selecting the Focus Mode.....	69
Selecting the Flash Mode.....	71
Selecting the Recorded Pixels.....	72
Selecting the Quality Level.....	73
Adjusting the White Balance.....	74
Changing the Focusing Area.....	76
Setting the Light Metering Range to Determine the Exposure.....	77
Setting the Sensitivity.....	78
Setting the Instant Review Time.....	79
Setting the Image Sharpness.....	80
Setting the Color Saturation.....	81
Setting the Image Contrast.....	82
Setting the Exposure (EV Compensation).....	83
<b>Saving the Settings.....</b>	<b>84</b>
Saving the Menu Items (Memory).....	84
Registering Functions in User Mode.....	85
<b>Recording and Playback.....</b>	<b>86</b>
<b>Recording Sound (Voice Recording Mode).....</b>	<b>86</b>
<b>Playing Back Sound.....</b>	<b>87</b>
<b>Adding a Voice Memo.....</b>	<b>88</b>
Setting the Record Voice Memo to [Off].....	88
<b>Playback/Deleting/Editing.....</b>	<b>89</b>
<b>Playing Back Images.....</b>	<b>89</b>
Playing Back Still Pictures.....	89
Zoom Display.....	89
Playing Back Moving Pictures.....	91
Displaying Shooting Information in Playback Mode.....	92
Nine Image Display.....	93
Slideshow.....	94

<b>Deleting Images, Moving Pictures and Sound</b> .....	<b>95</b>
Deleting a Single Image or Sound .....	95
Deleting All Images .....	97
Protecting Images and Sounds from Deletion (Protect) .....	98
<b>Viewing Images on a TV</b> .....	<b>99</b>
<b>Setting the Printing Service (DPOF)</b> .....	<b>100</b>
Printing Single Images .....	100
Printing All Images .....	102
<b>Direct Printing Using PictBridge</b> .....	<b>103</b>
Connecting the Camera to the Printer .....	103
Printing Single Images .....	104
Printing All Images .....	105
Printing Using the DPOF Settings .....	105
Disconnecting the Camera from the Printer .....	106
<b>Editing Images</b> .....	<b>107</b>
Changing the Image Size and Quality .....	107
Trimming Images.....	109
<b>Copying Files</b> .....	<b>110</b>

## **Settings** **112**

---

<b>Camera Settings</b> .....	<b>112</b>
Formatting an SD Memory Card or the Built-in Memory .....	112
Changing the Start-up Screen .....	113
Changing the Sound Settings.....	114
Changing the Date and Time .....	115
Setting the World Time .....	116
Changing the Display Language .....	118
Changing the Video Output Format .....	119
Changing the USB Connection Mode .....	119
Sleep Timeout .....	120
Setting Auto Power Off.....	120
Registering a Function (Custom Function).....	121
Setting the QUICK Button .....	122
Resetting to Default Settings .....	123
<b>Setting the Alarm</b> .....	<b>124</b>
Checking the Alarm .....	124
Setting the Alarm .....	124
Turning the Alarm Off .....	125

## **Appendix** **126**

---

<b>List of City Codes</b> .....	<b>126</b>
<b>Optional Accessories</b> .....	<b>127</b>
<b>Messages</b> .....	<b>128</b>
<b>Troubleshooting</b> .....	<b>130</b>
<b>Main Specifications</b> .....	<b>132</b>
<b>WARRANTY POLICY</b> .....	<b>134</b>

# Contents of the Operating Manual

This operating manual contains the following chapters.

## 1 Getting Started

This chapter explains what you need to do after purchasing the camera before you start taking pictures. Be sure to read it and follow the instructions.

## 2 Quick Start

This chapter explains the simplest way to take pictures and play back images. Use it if you want to start taking pictures straightaway.

## 3 Common Operations

This chapter explains common operations such as the functions of the buttons and how to use the menus. For more details, refer to the respective "Taking Pictures", "Recording and Playback", "Playback/Deleting/Editing" and "Settings" chapters.

## 4 Taking Pictures

This chapter explains the various way of capturing images and how to set the relevant functions, including how to use the Capture Mode screen to select the capture mode best suited to the situation.

## 5 Recording and Playback

This chapter explains how to record sound only or add a voice memo to an image, and how to play back voice memos.

## 6 Playback/Deleting/Editing

This chapter explains how to play back images on the camera or on a TV, how to delete, resize and trim images, and how to print images directly to the printer.





## 7 Settings

This chapter explains how to set the camera-related functions.

## 8 Appendix

This tells you about the messages displayed on the LCD monitor and what to do in the event of trouble.

The meanings of the symbols used in this operating manual are explained below.

	indicates the reference page number for an explanation of the related operation.
	indicates information that is useful to know.
	indicates precautions to be taken when operating the camera.
	The icons above the title show the Capture modes that can activate the function. Ex.)  <b>Setting the Image Sharpness</b>

1

2

3

4

5

6

7

8

## Checking the Contents of the Package



Camera  
Optio S4i

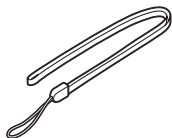

Strap  
O-ST20 (\*)

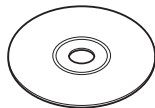

Software (CD-ROM)  
S-SW20

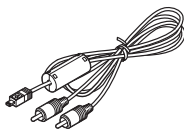

AV cable  
I-AVC7 (\*)

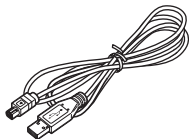

USB cable  
I-USB7 (\*)



Rechargeable  
lithium-ion battery  
D-LI8 (\*)

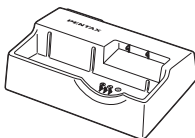

Battery charger  
D-BC20 (\*)



AC plug cord  
D-CO2J



Operating Manual  
(this manual)

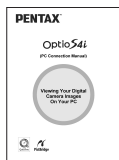

Operating Manual  
(PC Connection Manual)

Items marked with an asterisk (\*) are also available as optional accessories. For other optional accessories, refer to "Optional Accessories" (p.127).

## Names of Parts

### Front

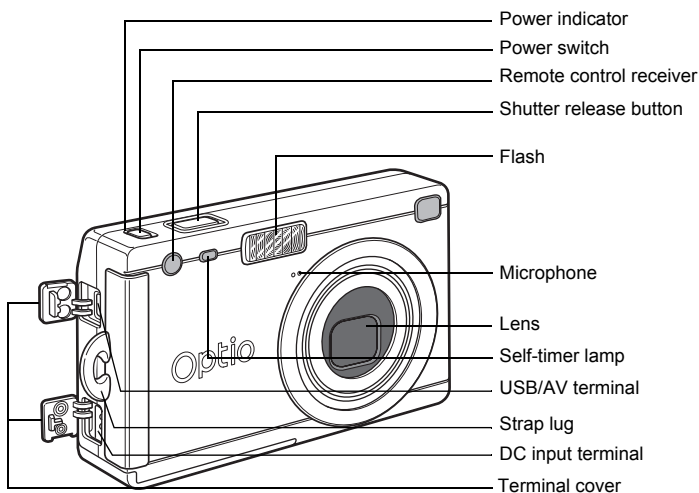

### Back

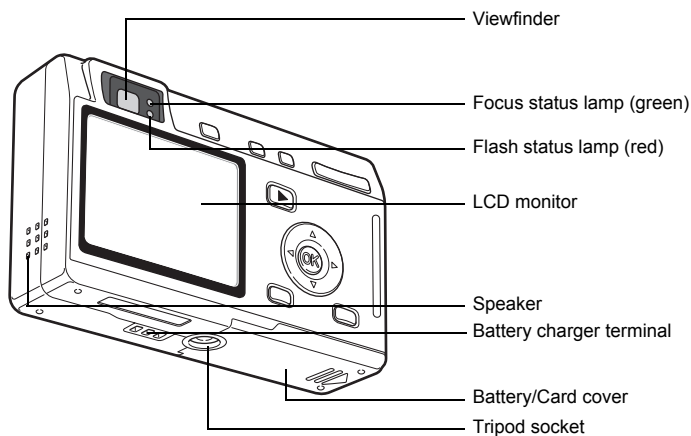

## Names of Operating Parts

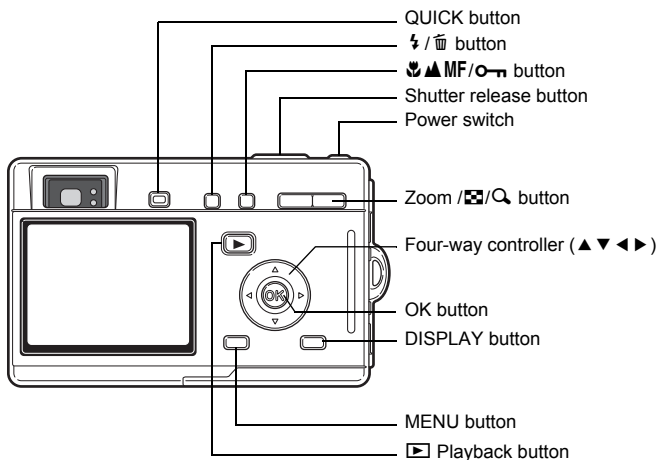

### Guide Indications

A guide to available button operations appears on the LCD monitor during operation.

The buttons are indicated as shown below.

Four-way controller (▲)	▲
Four-way controller (▼)	▼
Four-way controller (◀)	◀
Four-way controller (▶)	▶
MENU button	
Shutter release button	

Zoom /📷/🔍 button	
for digital zoom	
for trimming	
DISPLAY button	
🗑️ button	
🔑 button	
OK button	

## Attaching the Strap

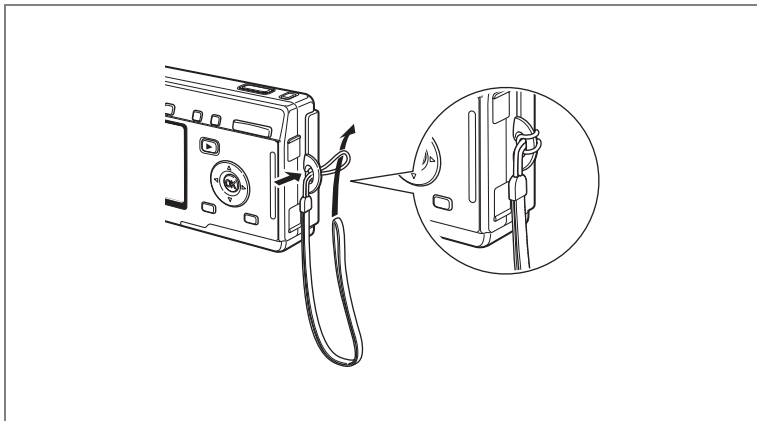

Pass the narrow end of the strap through the strap lug and pass the other end through the loop.

# Powering the Camera

1

Getting Started

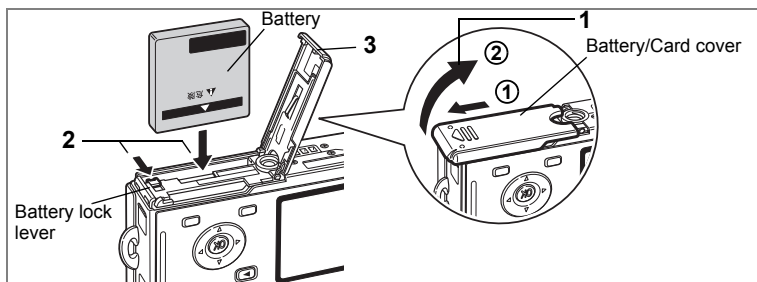

## Installing the Battery

Install the battery provided with the camera.

### 1 Open the battery/card cover.

Slide the battery/card cover in the direction indicated by the arrow ① and flip the cover open ②.

### 2 Insert the battery with the ▲ symbol facing toward the LCD monitor while using the side of the battery to press the battery lock lever in the direction indicated by the arrow.

### 3 Close the battery/card cover.

## Removing the Battery

### 1 Release the battery by using your finger to press the battery lock lever in the same direction as when you inserted the battery.

Pull the battery out.



If you intend to use the camera continuously for a long period, use of the AC adapter D-AC8 (optional) is recommended. (p.18)



- Insert the battery correctly. If the battery is incorrectly oriented, it may cause malfunction.
- Do not remove the battery when the camera is turned on.
- If you do not intend to use the camera for a long time, remove the battery.
- If the camera is left without the battery for a long time, the date will be reset.



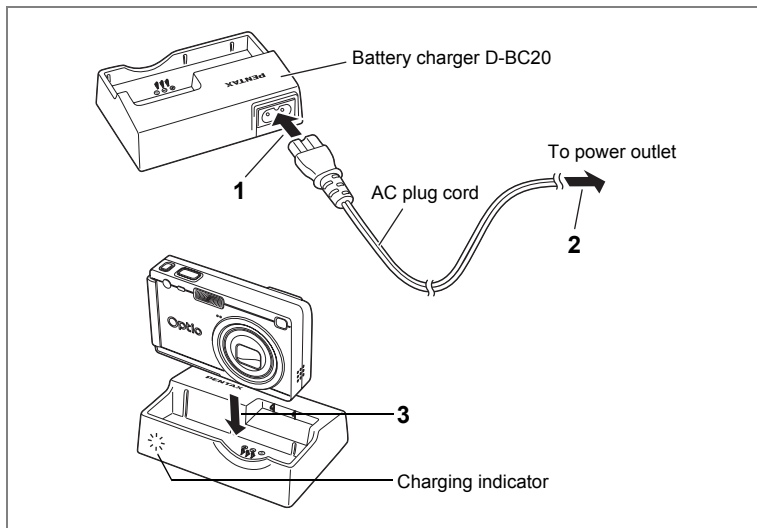

## Charging the Battery

Use the optional D-BC20 battery charger to charge the battery before using the camera for the first time or when the [Battery depleted] message appears. You can charge the battery without removing it from the camera.

- 1 Connect the AC plug cord to the battery charger D-BC20.**
- 2 Plug the AC plug cord into the power outlet.**

### Charging the Battery in the Camera

- 3 Place the camera in the charger.**

Turn the camera off and position the camera so that the lens rests in the depression in the case. The charging indicator on the charger blinks red while the battery is charging and lights red when charging is completed.
- 4 Remove the camera from the battery charger when charging is completed.**

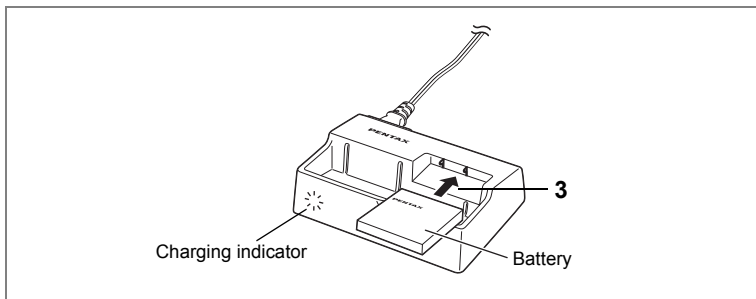

### Charging the Battery by Itself

You can remove the battery from the camera and charge it.

#### 3 Place the battery in the charger so that the PENTAX name is visible.

The charging indicator blinks red while the battery is charging and lights red when charging is completed.

#### 4 Remove the battery from the battery charger when charging is completed.



- The time required for full charge is about 100 minutes. The appropriate ambient temperature range for charging the battery is 0°C – 40°C (32°F to 104°F).
- The charging time may vary depending on the ambient temperature and charging conditions.
- When the battery reaches the end of its service life, the time that the camera can be operated becomes shorter even when the battery is fully charged. In this event, replace the battery.
- You can also remove the battery from the camera and charge it using the optional D-BC8 battery charger kit.



- Always charge the battery before using the camera for the first time or when the battery has not been used for a long time.
- Do not use the D-BC20 battery charger to charge batteries other than D-LI8 rechargeable lithium-ion batteries, as the charger may overheat or be damaged as a result.
- If the battery is inserted correctly but the charging indicator fails to blink, the battery may be faulty. Replace with a new battery.

## • Approximate Operating Time (when the D-LI8 battery is fully charged)

Number of recordable images: Approx. 180 (at 25°C with the LCD monitor on and the flash used for 50% of shots)

Playback time: Approx. 110 min.

- The above figures are based on PENTAX measuring conditions and may vary depending on capture mode and shooting conditions.



- In general, battery performance temporarily deteriorates as the temperature decreases. When using the camera in a cold environment, keep it warm by putting it in your pocket or inside your coat. Battery performance that has deteriorated due to low temperature will be restored when the battery is returned to room temperature.
- Be sure to take a spare battery with you when traveling abroad or to a cold region, or if you intend to take a lot of pictures.

## • Battery Level Indicator

You can check the battery level by the  symbol on the LCD monitor.

 (lit green) : Adequate power remains.



 (lit green) : Battery is running low.



 (lit yellow) : Battery is running very low.



 (lit red) : Battery is exhausted.



[Battery depleted] : The camera will turn off after the message appears.

## • Recycling Batteries



This symbol indicates that the battery is recyclable. Cover the terminals with insulating tape and take the battery to a store displaying this symbol.

## Li-ion

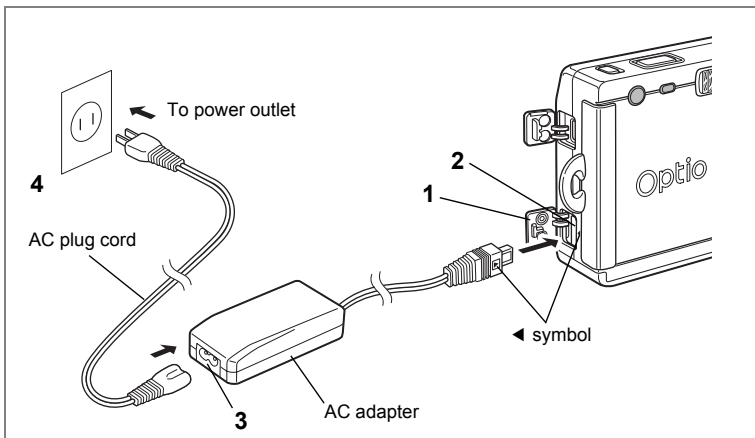

## Using the AC Adapter (optional)

If you intend to use the LCD monitor for a long time or connect the camera to a PC, use of the AC adapter D-AC8 is recommended.

- 1** Make sure that the camera is turned off and open the terminal cover.
- 2** Connect the DC terminal on the AC adapter to the DC input terminal on the camera, being sure to match the ◀ symbols.
- 3** Connect the AC plug cord to the AC adapter.
- 4** Plug the AC plug cord into the power outlet.



- Make sure that the camera is turned off when connecting or disconnecting the AC adapter.
- Make sure that the AC plug cord and connecting cable are inserted securely. The data may be lost if the cable becomes disconnected while you are taking pictures.
- Be sure to read the operation manual accompanying the AC adapter before using the adapter.
- Be sure to match the ◀ symbols when connecting the DC terminals. Inserting the plugs with too much force may damage them.

## Precautions When Using the Battery Charger or AC Adapter

To avoid the risk of fire or electric shock when using the battery charger or AC adapter, be sure to read the section on “FOR SAFE USE OF YOUR CAMERA” on page 1. Refer to page 132 for the specifications of the battery charger and AC adapter.

# Installing the SD Memory Card

1

Getting Started

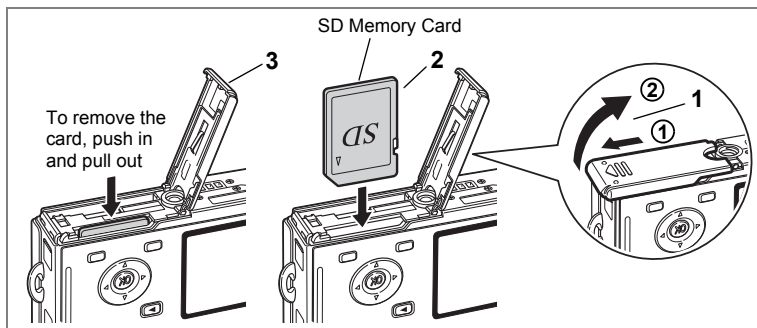

An SD Memory Card can be used with this camera. Captured images are recorded on the SD Memory Card if a card is inserted (☐ appears on the LCD monitor) or in the built-in memory if no card is inserted (📷 appears on the LCD monitor).



Make sure that the camera is turned off before inserting or removing the SD Memory Card.

- 1 Open the battery/card cover.**  
Slide the battery/card cover in the direction indicated by the arrow ① and flip the cover open ②.
- 2 Insert an SD Memory Card so the label (the side with the ▲ symbol) is facing toward the LCD monitor and push the card in until it clicks.**
- 3 Close the battery/card cover.**  
To remove the card, eject the card by pressing it in the direction indicated by the arrow and pull it out.



The number of recordable images varies depending on the capacity of the SD Memory Card or built-in memory and the selected image size and quality. (p.22)

## Data Backup

Very occasionally, data stored in the built-in memory becomes unreadable. As a backup measure, we recommend that you download important data to a PC or store the data in a media other than the built-in memory.

## Precautions When Using an SD Memory Card

- Make sure that the camera is turned off before opening the card cover.
- The SD Memory Card is equipped with a write-protect switch. Setting the switch to [LOCK] protects the existing data by prohibiting recording of new data, deletion of existing data or formatting of the card.
- Care should be taken if you remove the SD Memory Card immediately after using the camera, as the card may be hot.
- Do not remove the SD Memory Card or turn the camera off while data is being recorded on the card, images or sound are being played back, or the camera is connected to a PC with the USB cable as this may cause the data to be lost or the card to be damaged.
- Do not bend the SD Memory Card or subject it to violent impact. Keep it away from water and store away from high temperature.
- Be sure to format unused cards or cards that have been used on another camera. Refer to "Formatting an SD Memory Card or the Built-in Memory" (p.112) for instructions on formatting.
- Do not remove the SD Memory Card during formatting as this may damage the card and render it unusable.
- The data on the SD Memory Card may be deleted in the following circumstances.
  - (1) when the SD Memory Card is mishandled by the user.
  - (2) when the SD Memory Card is exposed to static electricity or electrical interference.
  - (3) when the card has not been used for a long time.
  - (4) when the card is ejected, the AC adapter is disconnected or the battery is removed while the data on the card is being recorded or accessed.
- The SD Memory Card has a limited service life. If it is not used for a long time, the data on the card may become unreadable. Be sure to make a backup of important data on a PC.
- Avoid using or storing the card where it may be exposed to static electricity or electrical interference.
- Avoid using or storing the card in direct sunlight or where it may be exposed to rapid changes in temperature or to condensation.
- When using an SD Memory Card with a slow recording speed, recording may stop while you are taking moving pictures even when there is adequate space in the memory, or shooting and playback may take a long time.
- When you purchase the SD Memory Cards, access the PENTAX website and confirm beforehand if they have compatibility with your camera. Inquiries on the card compatibility can also be answered by your nearest PENTAX service center.

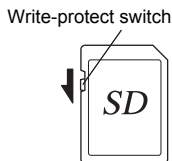

## Image Size and Quality

Choose the image size and quality best suited to your purpose. Higher quality levels and numbers of recorded pixels produce clearer images for printing, but the resulting increase in data volume reduces the total number of pictures that can be taken.

Choose the appropriate number of recorded pixels and quality level on the [📷 Rec. Mode] menu.

How to Set the Menu [p.36](#)

Selecting the Recorded Pixels [p.72](#)

Selecting the Quality Level [p.73](#)

### ● Appropriate Sizes According to Use

2304×1728	Suitable for printing on A4 paper (8 1/2 in. × 11 1/2 in.)
1600×1200	Suitable for printing on A5 paper
1024×768	Suitable for printing on postcards
640×480	Suitable for attaching to e-mails or creating websites

The default setting is 2304×1728.

### ● Appropriate Quality According to Use

★★★	Best	Lowest compression ratio. Suitable for large A4-size photo prints.
★★	Better	Standard compression ratio. Suitable for photo prints or viewing images on a computer screen.
★	Good	Highest compression ratio. Suitable for attaching to e-mails or creating websites.

The default setting is ★★.

### ● Approximate Number of Recordable Images by Size and Quality

Quality Level Recorded Pixels	Best ★★★	Better ★★	Good ★	Moving Picture (320×240)
2304×1728	3	6	10	53 sec.
1600×1200	8	14	20	
1024×768	18	33	43	
640×480	40	62	83	

- The above table indicates the number of images when using the built-in memory (10MB).
- The above table is based on standard shooting conditions specified by PENTAX and may vary depending on the subject, shooting conditions, capture mode, SD Memory Card, etc.



# Initial Settings

1

Getting Started

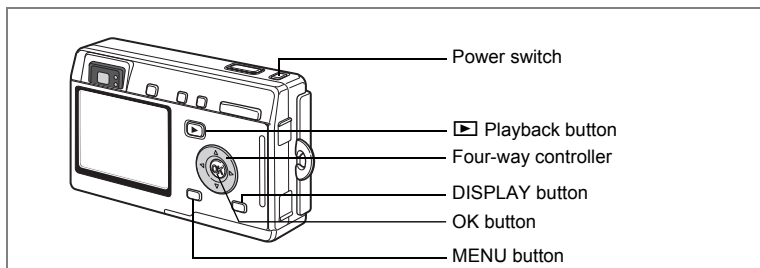

If the Initial Settings screen or Date Adjust screen appears when you turn the camera on, follow the procedure below to set the display language and/or current date and time.

If the Initial Settings screen appears:

☞ p.23 - 24 “Setting the Display Language”, “Setting the Date and Time”

If the Date Adjust screen appears:

☞ p.24 - 25 “Setting the Date and Time”

If neither screen appears, setting is not required.

## Setting the Display Language

You can choose the language in which the menus, error messages, etc. are displayed from the following: English, French, German, Spanish, Italian, Russian, Chinese (traditional and simplified) and Japanese.

- 1 Turn the camera on.**
- 2 Use the four-way controller (◀▶) to choose the display language.**

The default setting is English.

- 3 Press the OK button.**

The Date Adjust screen appears.

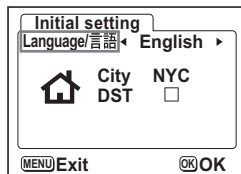

## Setting the Date and Time

Set the current date and time and the display style.

1

Getting Started

- 1 Use the four-way controller (▲▼) to choose the date and time display style.

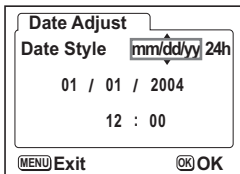

- 2 Press the four-way controller (▶).  
▲ and ▼ appear above and below "24h".

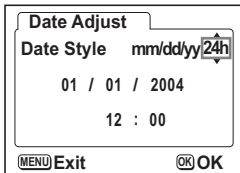

- 3 Use the four-way controller (▲▼) to select [24h] (24-hour display) or [12h] (12-hour display).

- 4 Press the four-way controller (▶).  
▲ and ▼ appear above and below the month.

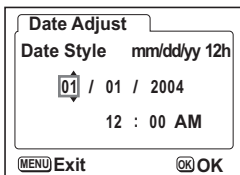

- 5 Use the four-way controller (▲▼) to change the month.

- 6 Press the four-way controller (▶).  
▲ and ▼ appear above and below the day.

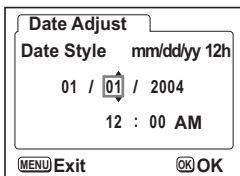

- 7 Use the four-way controller (▲▼) to change the day and press the four-way controller (▶).  
▲ and ▼ appear above and below the year.

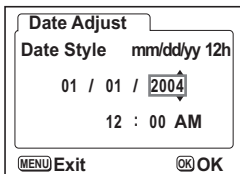

## 8 Repeat Step 7 to change the [year], [hour] and [minutes].

Choose AM or PM if you selected [12h] in Step 3.

## 9 Press the OK button when you have finished the settings.

The camera is ready to take pictures. If you set the date and time using the MENU button, you will return to the Menu screen. Press the OK button again.



- When you finish the settings and press the OK button, the camera clock is reset to 00 seconds.
- To set the exact time, press the OK button when the time signal (on the TV, radio, etc.) reaches 00 seconds.



- When the Initial Settings screen is displayed, you can cancel the setting operation and switch to Capture mode by pressing the MENU button. In this case, the screen will appear next time you turn the camera on.
- You can change the settings after they have been made. Refer to "Changing the Date and Time" (p.115).

## Taking Still Pictures

2

Quick Start

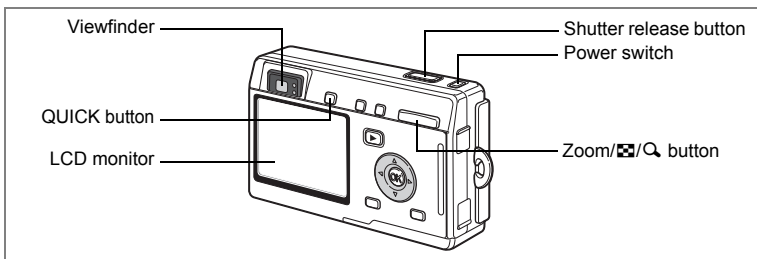

The simplest procedure for taking still pictures is described below. The flash fires automatically depending on the light conditions.

### 1 Press the power switch.

The camera turns on.

### 2 Confirm the subject and shooting information on the LCD monitor.

The focus frame in the middle of the LCD monitor indicates the zone of automatic focusing. You can change the size of the subject by pressing the Zoom/□/Q button.

⬆ : makes the subject bigger.

⬆⬆ : makes the subject smaller.

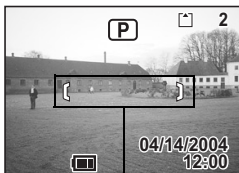

Focus frame

You can check the size of the subject by looking through the viewfinder.



- As there is no focus frame in the viewfinder, be sure to check the focusing area on the LCD monitor.
- To switch to the Green mode and let the camera set all the shooting functions automatically, press the QUICK button. Selecting the Green mode is the easiest way to ensure that pictures come out well. "Taking Pictures by the Simplest Procedure" (p.40)

### 3 Press the shutter release button halfway.

The focus frame on the LCD monitor will light green when the camera is in focus.

### 4 Press the shutter release button.

The image appears on the LCD monitor for one second (Instant Review) and is recorded on the SD Memory Card or in the built-in memory. (The green and red lamps on the right of the viewfinder blink alternately while the image is being recorded.)

## Using the Shutter Release Button

The shutter release button works in a two-step action as follows.

### Press halfway

The focus, exposure and white balance are locked when the shutter release button is pressed lightly (halfway). The shutter speed and aperture settings only appear on the LCD monitor when the shutter release button is pressed halfway. The following information is indicated on the LCD monitor and by the focus status and flash status lamps when the shutter release button is pressed halfway.

#### 1. Focus frame

The focus frame turns green if the subject is in focus. The frame does not appear if the subject is out of focus.

#### 2. Status lamps

	Focus status lamp (green)	Flash status lamp (red)
Lit	Subject is in focus	Flash is charged
Blinks	Subject is out of focus	Flash is charging

Pictures cannot be taken while the flash is charging.

### Press down fully

Press the shutter release button all the way down (fully) to take a picture.

[Poor focusing conditions]

The camera may not be able to focus under the following conditions. In this case, lock the focus on an object the same distance away as the subject (by pressing the shutter release button halfway), then aim the camera at your subject and press the shutter release button fully.

- Objects that lack contrast such as a blue sky or white wall
- Dark places or objects, or conditions that prevent light being reflected back
- Finely patterned object
- Fast moving objects
- When there is an object in the foreground and an object in the background in the same picture
- Strongly reflected light or strong backlighting (bright background)

## Instant Review

The Instant Review default setting is one second. During this time, you can delete the image by pressing the  button, selecting [Delete] when the [Delete] menu appears and pressing the OK button. (p.96)

You can also record a voice memo by pressing the OK button during Instant Review. (p.88)

Setting the Instant Review Time p.79

## Playing Back Still Pictures

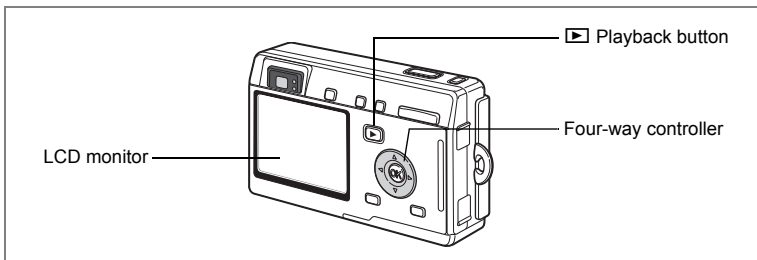



### Playing Back an Image

You can display the still picture you have just taken.

- 1 **Press the  Playback button after taking a picture.**

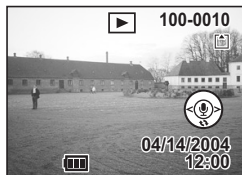
The image appears on the LCD monitor.



Zoom Display  p.89

### Playing Back the Previous or Next Image

Still pictures can be played back one at a time, proceeding either forward or backward.

- 1 **Press the  Playback button after taking a picture.**

The image appears on the LCD monitor.

- 2 **Press the four-way controller ( ).**



displays the previous image.



displays the next image.

## Rotating the Displayed Image

### 1 Press the Playback button after taking a picture.

The image appears on the LCD monitor.



### 2 Press the four-way controller ()

The image is rotated 90° clockwise each time the button is pressed.





Press the four-way controller () to return to normal playback. The zoom display and nine-image display functions cannot be used with rotated images, nor can DPOF or delete/protect settings be made.

## Deleting the Displayed Image

You can delete the image displayed on the LCD monitor by pressing the  button, using the four-way controller () to select [Delete] and pressing the OK button.

Press the  Playback button again or press the shutter release button halfway to return to the Capture mode.



- The last picture taken appears on the LCD monitor when you switch to the Playback mode.
- You can enlarge the image displayed on the LCD monitor by pressing the Zoom /  /  button.
- If there are no images stored, the [No image or sound] message appears.

Deleting Images, Moving Pictures and Sound  p. 95

## Turning the Camera On and Off

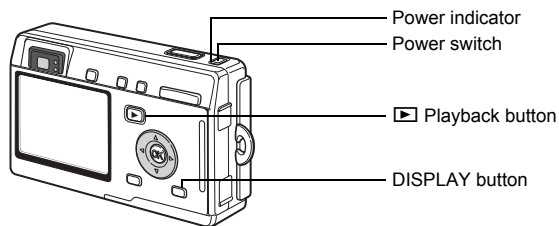



3

**1 Press the power switch.**

The power switch is illuminated by a green light. The lens extends and the camera turns on in the Capture mode.

The camera is ready to take pictures by pressing the shutter release button.

- Press the  Playback button to switch to the Playback mode and view pictures while the lens is extended.
- Hold down the  Playback button for more than two seconds to activate the Lens Closed Playback mode.

**2 Press the power switch again.**

The camera turns off.

Switching between Capture Mode and Playback Mode  
 p.66

Taking Pictures  p.40







## Lens Closed Playback Mode

When the camera is turned on in the Lens Closed Playback mode, the lens does not extend. Use this mode when you want to play back pictures one after another.

### 1 Press the power switch while pressing the Playback button.

The power indicator lights green and the camera turns on in the Lens Closed Playback mode.

- Press the  Playback button to extend the lens and switch to the Capture mode.
- Hold down the  Playback button for more than two seconds in the Capture mode or press the  Playback button in the Voice Recording mode to switch to the Lens Closed Playback mode.

Playing Back Still Pictures  p.28

## Voice Recording Mode

You can use the camera as a voice recorder.

There are two ways to activate the Voice Recording mode.

### 1 Press the power switch for more than two seconds.

The power indicator lights green and then changes to red, and the camera turns on in the Voice Recording mode.

### 1 Press the power switch while pressing the DISPLAY button.

The power indicator lights red and the camera turns on in the Voice Recording mode.

- Press the  Playback button to switch to the Lens Closed Playback mode.

Recording Sound  p.86

# Using the Button Functions

3

Common Operations

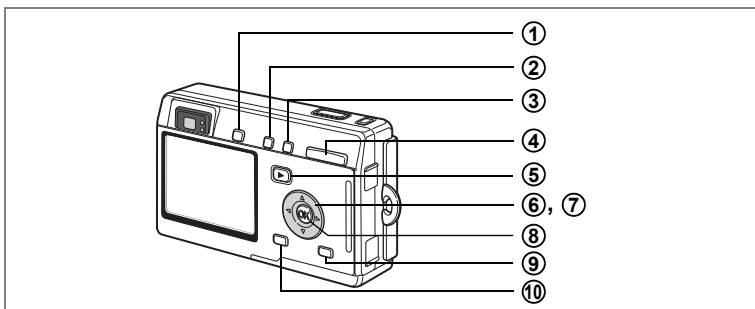

## Capture Mode

- ① **QUICK button**  
Switches to the Green mode, the easiest way to take pictures. (☞p.40)  
You can assign a different function to the QUICK button by selecting [QUICK Button] on the [⏏ Set-up] menu. (☞p.122)
- ② **⚡ button**  
Changes the flash mode. (☞p.71)
- ③ **👁️▲ MF button**  
Changes the focus mode as follows. (☞p.69)  
Macro mode (☞p.69)                      Super Macro mode (☞p.69)  
Infinity-Landscape mode (☞p.69)        Manual Focus mode (☞p.70)  
Focusing Area mode (☞p.70)
- ④ **Zoom button**  
Changes the size of the subject. (☞p.26)
- ⑤ **▶ Playback button**  
Switches to the Playback mode. When pressed again, returns to Capture mode. (☞p.28)
- ⑥ **Four-way controller (◀▶)**  
Changes the EV compensation. (☞p.83)  
You can assign a different function to the key by selecting [Custom Function] on the [⏏ Set-up] menu. (☞p.121)  
Adjusts the ratio when the digital filter is set to the slim filter. (☞p.50)

- ⑦ **Four-way controller (▲▼)**  
(▲) Selects self-timer mode, remote control mode and continuous shooting mode.  
(▼) Displays the Capture mode screen and changes the Capture mode.  
(▲▼) Adjusts the focus in manual focus mode. (p.70)
- ⑧ **OK button**  
Selects a menu item. (p.36)  
Performs spot autofocus at the standard autofocus distance in manual focus mode.
- ⑨ **DISPLAY button**  
Changes the information displayed on the LCD monitor. (p.68, 92)
- ⑩ **MENU button**  
Displays the [📷 Rec.Mode], [▶ Playback] and [⚙️ Set-up] menus. (p.36)

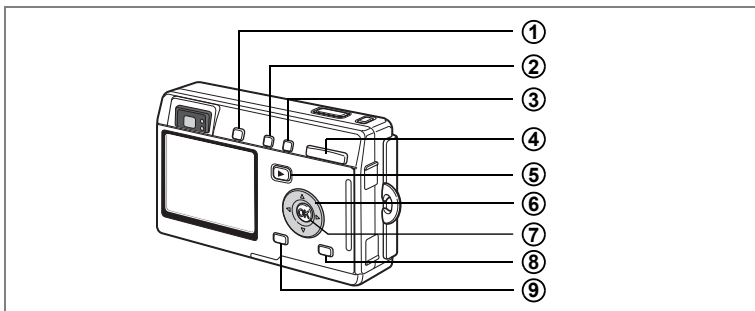

## Playback Mode

- ① QUICK button**  
Switches to the Green mode, the easiest way to take pictures. (☞p.40)  
You can assign a different function to the QUICK button by selecting [QUICK Button] on the [⚙️ Set-up] menu. (☞p.122)
- ② 🗑️ button**  
Deletes the image displayed on the LCD monitor. (☞p.95)
- ③ 🔒 button**  
Protects the image displayed on the LCD monitor from deletion. (☞p.98)
- ④ Zoom/📷/🔍 button**  
Press 📷 during normal playback to display nine images at once. (☞p.93)  
Press Zoom/📷/🔍 button during zoom playback to change the size of the Zoom Display image displayed on the LCD monitor. (☞p.89)
- ⑤ ▶️ Playback button**  
Switches to Capture mode. (☞p.26, 86)
- ⑥ Four-way controller**  
(▲) Sets the DPOF settings for the print service. (☞p.100)  
(◀▶) Displays the previous or next image. (☞p.28)  
(▼) Rotates the image. (☞p.29)
- ⑦ OK button**  
Selects a menu item. (☞p.36)  
Records or plays back a voice memo. (☞p.88)
- ⑧ DISPLAY button**  
Changes the information displayed on the LCD monitor. (☞p.68, 92)
- ⑨ MENU button**  
Displays the [📷 Rec.Mode], [▶️ Playback] and [⚙️ Set-up] menus. (☞p.36)

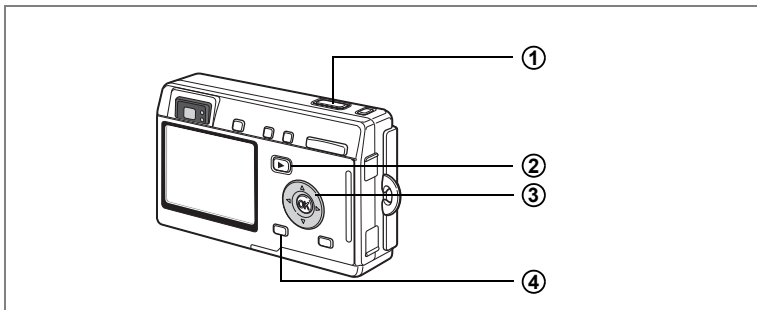

## Voice Recording Mode

### ① Shutter release button

When pressed, starts recording, and when pressed again, stops recording. When pressed for more than one second, recording continues for as long as the button is held down and stops when the button is released.

### ② Playback button

Switches to Lens Closed Playback mode. (p.31) When pressed again, returns to Voice Recording mode.

### ③ Four-way controller (in Lens Closed Playback mode)

(▲) Starts playback. When pressed again, pauses playback.

(◀▶) Performs the following operations during playback. Selects a recorded file before playback.

If there are no recorded indexes:

When (◀) is pressed during playback, rewinds five seconds.

When (▶) is pressed during playback, advances five seconds.



If there are recorded indexes:

When (◀) is pressed during playback, plays back starting from the previous index.

When (▶) is pressed during playback, plays back starting from the next index.

### ④ MENU button

When pressed during recording, an index can be added.

When pressed during standby or before recording or playing back, displays the [ Playback] and [ Set-up] menus. (p.36)

# Setting the Menu

When you press the MENU button, the menus appear on the LCD monitor. You can set functions, save the settings and change the camera settings on these menus.

## How to Set the Menu

When you are making settings from a menu, a guide to operation appears on the LCD monitor.

### 1 Press the MENU button.

The [📷 Rec.Mode] menu appears when you display the menu from Capture mode, and the [▶ Playback] menu appears when you display the menu from Playback mode.

The selected area appears in a green frame.

### 2 Press the four-way controller (◀▶).

Changes the menu screen.

### 3 Use the four-way controller (▲▼) to choose an item.

Moves the frame up or down.

### 4 Use the four-way controller (◀▶) to change the setting.

### 5 If there is a select screen, use the four-way controller (▶) to move to the select screen.

Press the OK button to return to the menu when you have finished making the settings.

### 6 Press the OK button.

The settings are saved and the screen returns to capture or playback status.



- If you press any buttons before pressing the OK button to exit the menu, any changes you have made to the settings will not be saved.
- Even after pressing the OK button to exit the menu, if you turn the camera off incorrectly (such as by removing the battery while the camera is turned on), any changes you have made to the settings will not be saved.
- The menu is exited automatically one minute after the last operation.

## Example of Menu Operation

### 1 MENU button

[CAMERA] [Rec.Mode] Menu

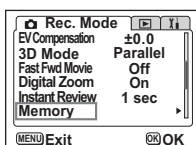
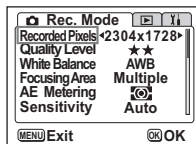
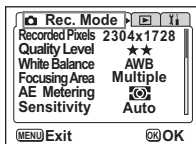

To the next screen

### 2

[PLAYBACK] [Playback] Menu



[SETUP] [Set-up] Menu



### 4



### 4'

Select Screen

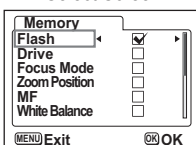



If you press the shutter release button halfway to exit the menu and switch to Capture mode, any changes you have made to the settings will not be saved.

## Menu List

### [ Rec.Mode] Menu

Yes ... Adjustable

No ... Any changes made are invalid. You can change the setting on the menu, but any changes you make are invalid in actual operation.

Item	Description	Default Setting	Green Mode	Moving Picture Mode	Other Modes	Page
Recorded Pixels	For selecting the number of pixels	2304 × 1728	No	320×240	Yes	p.72
Quality Level	For selecting the image compression ratio	★★	No	No	Yes	p.73
White Balance	For adjusting the color balance according to lighting	AWB (Auto)	No	Yes	Yes	p.74
Focusing Area	For changing the area of the autofocus	[  ] (Multiple)	No	No	Yes	p.76
AE Metering	For setting the metering method to determine the exposure	 (Multi-segment)	No	Yes	Yes	p.77
Sensitivity	For setting the sensitivity	Auto	No	No	Yes	p.78
EV Compensation	For adjusting the exposure between -2.0 and +2.0	±0.0	No	Yes	Yes	p.83
3D Mode	For taking 3D pictures	Parallel mode	No	No	Yes (3D only)	p.55
Time-Lapse Movie	For setting the frame rate when recording moving pictures	Off	No	Yes	No	p.65
Digital Zoom	For taking digital zoom pictures	On	No	Yes	Yes	p.63
Instant Review	For setting the Instant Review time	1 sec.	No	No	Yes	p.79
Memory	For saving the shooting function settings when the camera is turned off	—	No	Yes	Yes	p.84
Sharpness	For setting the sharpness	Normal	No	No	Yes	p.80
Saturation	For setting the saturation	Normal	No	No	Yes	p.81
Contrast	For setting the contrast	Normal	No	No	Yes	p.82



## [▶ Playback] Menu

Item	Description	Page
Slideshow	For playing recorded images successively	p.94
Resize	For changing the size of images	p.107
Trimming	For trimming images	p.109
Copy Image & Sound	For copying files from the built-in memory to the SD Memory Card and vice versa	p.110
Alarm	For setting the alarm to ring at a specific time	p.124
Record Voice Memo	For adding a voice memo to an image	p.88
Quick Zoom	For playing back images at the maximum zoom size by pressing the Zoom/⏏/Q button only once	p.90
Quick Delete	For displaying the Delete screen with [Delete] or [Delete All] highlighted when ON is selected	p.96

## [⚙️ Set-up] Menu

Item	Description	Page
Format	For formatting the SD Memory Card or built-in memory	p.112
Sound	For adjusting the playback volume and setting the type and volume of start-up sound, shutter sound, key operation sound, etc.	p.114
Date Adjust	For adjusting the date and time	p.115
World Time	For setting the world time	p.116
Language/言語	For changing the language in which menus and messages appear	p.118
Start-up Screen	For selecting the start-up screen when the camera is turned on	p.113
Video Out	For setting the video output format	p.119
USB Connection Mode	For changing the USB connection mode	p.119
Sleep Timeout	For setting the power saving function	p.120
Auto Power Off	For turning off the power automatically	p.120
Custom Function	For registering a function on the four-way controller (◀▶)	p.121
QUICK Button	For registering a function on the QUICK button	p.122
Reset	For returning the camera settings to defaults	p.123

## Taking Pictures

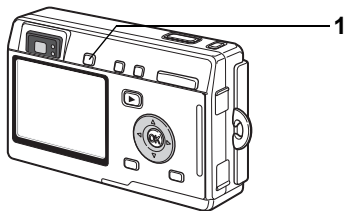

4



## Taking Pictures by the Simplest Procedure (Green Mode)

The Green mode lets you take pictures quickly and easily, simply by pressing the shutter release button. In  (Green) mode, the camera automatically sets all the functions, including the shutter speed and aperture. You can use the zoom button to change the size of the subject.

### 1 Press the QUICK button in Capture mode or Playback mode.

You can switch to the Green mode at any stage of operation in Capture mode or Playback mode.

Press the QUICK button again to return to the mode before the Green mode was activated.

Press the  button,  button or four-way controller () to switch to the Program mode.



### 2 Press the shutter release button halfway.

The focus frame on the LCD monitor will light green when the camera is in focus.

### 3 Press the shutter release button.

The picture is taken.



- If the camera is turned off in the Green mode, it will turn on again in the Green mode the next time the power switch is pressed. The Green mode start-up screen will appear.
- No settings, including the flash mode and focus mode, can be changed in the Green mode.

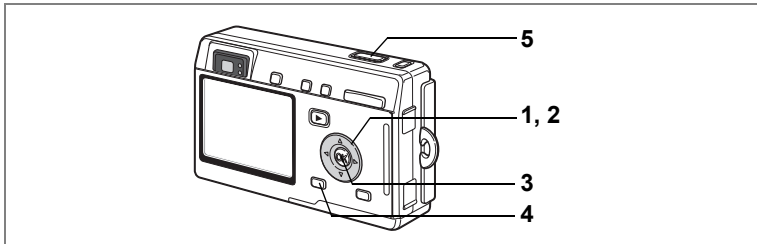

## Setting the Functions (Program Mode)

In **P** (Program mode), the camera automatically sets the shutter speed and aperture for taking still pictures. However, you can select other functions such as the Flash mode or Continuous Shooting mode.

**1 Press the four-way controller (▼) in Capture mode.**

The Capture mode screen appears.

**2 Use the four-way controller (▲▼◀▶) to select **P** (Program mode).**

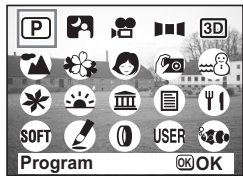

**3 Press the OK button.**

**4 Set the functions you want to use.**

Refer to “Setting the Shooting Functions” (p.66 to p.83) for details of how to set the functions.

**5 Press the shutter release button halfway.**

The focus frame on the LCD monitor will light green when the camera is in focus.

**6 Press the shutter release button.**

The picture is taken.

Taking Still Pictures p.26

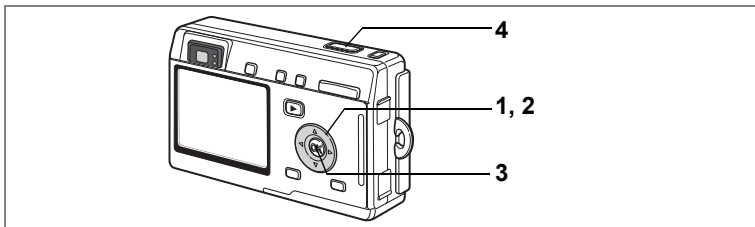

## Selecting the Picture Mode According to the Shooting Scene (Picture Mode)

You can select the Picture mode according to the shooting scene. There are ten available modes in Picture mode.

	Landscape	Lets you capture the natural colors of landscape views.
	Flower	Lets you take brightly colored flower pictures.
	Portrait	Lets you take portraits with spatial effect, by emphasizing the person.
	Self-Portrait	Lets you take pictures of yourself or be included in pictures.
	Surf & Snow	Lets you take photos against dazzling backgrounds like beaches or snow-covered mountains.
	Autumn Colors	Lets you take colorful pictures of trees in autumn.
	Sunset	Lets you reproduce the beautiful colors of the sunrise or sunset.
	Museum	Lets you take pictures of works of art in museums and galleries.
	Text	Lets you take clear pictures of text or writing.
	Food	Lets you take appetizing pictures of prepared food.

- 1 Press the four-way controller (▼) in Capture mode.**  
The Capture mode screen appears.
- 2 Use the four-way controller (▲▼◀▶) to choose the desired mode.**  
For example, select (Landscape mode).
- 3 Press the OK button.**
- 4 Press the shutter release button halfway.**  
The focus frame on the LCD monitor will light green when the camera is in focus.
- 5 Press the shutter release button.**  
The picture is taken.

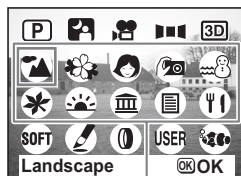
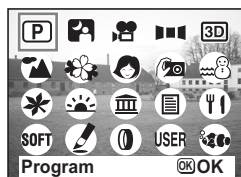

Picture mode



In Picture mode, the EV compensation, saturation, contrast, sharpness and white balance are automatically set to their default settings. You can change the settings.

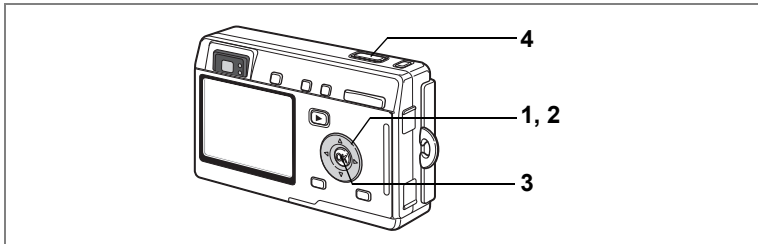

## Taking Pictures of Dark Scenes (Night-Scene Mode)

You can take pictures of dark scenes, such as nightscapes, with the appropriate settings.

**1 Press the four-way controller (▼) in Capture mode.**

The Capture Mode screen appears.

**2 Use the four-way controller (▲▼◀▶) to select  (Night-Scene mode).**



**3 Press the OK button.**

**4 Press the shutter release button halfway.**

The focus frame on the LCD monitor will light green when the camera is in focus.

**5 Press the shutter release button.**

The picture is taken.



Total recording time will be longer when the picture is taken at slower shutter speed, because the noise reduction activates to reduce noise.



The shutter speed is slower when taking pictures of dark scenes. To prevent camera shake, secure the camera on a tripod or other surface.

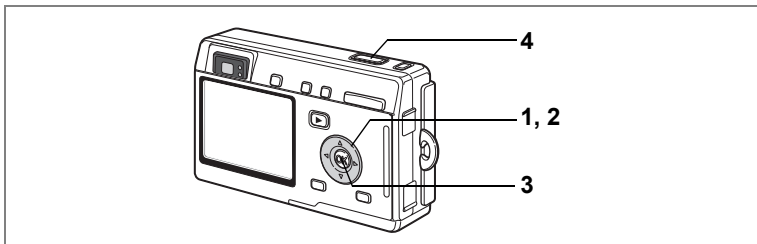



## Taking Moving Pictures (Moving Picture Mode)

This mode enables you to take moving pictures and sound.

- 1 Press the four-way controller (▼) in Capture mode.**

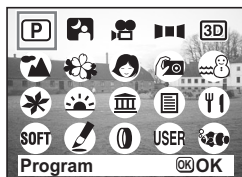
The Capture Mode screen appears.



- 2 Use the four-way controller (▲▼◀▶) to select  (Moving Picture mode).**

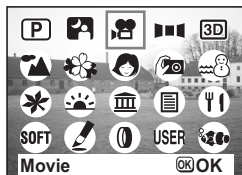

- 3 Press the OK button.**

The following shooting information appears on the LCD monitor and the camera is ready to take moving pictures.

- Flash Off icon
- Moving Picture mode icon
- Card/Built-in memory
- Recordable time



- 4 Press the shutter release button.**

Shooting starts. You can change the size of the image using the Zoom button.

▲ : makes the subject bigger.

▶▶▶ : makes the subject smaller.

- 5 Press the shutter release button.**

Shooting ends.

## Keeping the Shutter Release Button Pressed

If you keep the shutter release button pressed for more than one second, pictures will be taken for as long as you keep the button pressed. Shooting stops when you take your finger off the shutter release button.



- The flash will not discharge in Moving Picture mode.
- Continuous shooting is not possible in Moving Picture mode.
- The LCD monitor cannot be turned off in Moving Picture mode.
- Sound cannot be recorded when [Time-Lapse Movie] is set to On.
- Only Autofocus mode, Infinity-Landscape mode and Manual Focus mode can be set in Moving Picture mode. The focus is set to a fixed position in Autofocus mode.
- Only the digital zoom can be used to change the size of the image in Moving Picture mode. Use the LCD monitor when recording moving pictures using the digital zoom.
- The Marine Moving Picture mode enables you to record moving pictures using the waterproof case (optional).

Taking Time-Lapse Moving Pictures p.65

Taking Underwater Moving Pictures p.54

Playing Back Moving Pictures p.91

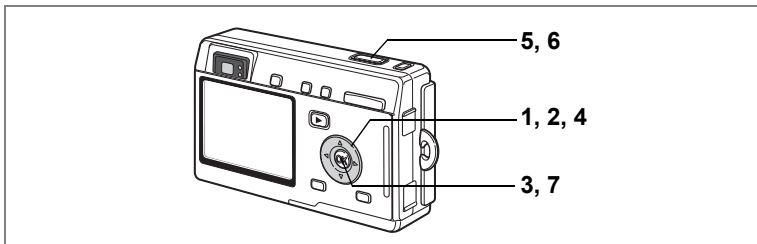

## Taking Panorama Pictures (Panorama Assist Mode)

You can take a number of images and join them together to form a panorama picture. The panorama software supplied with the camera (ACDSee for PENTAX) and a computer are necessary for joining the images. The Panorama Assist mode enables you to overlap the edges of the images so that they are easier to join together later into a panorama picture.

- 1 Press the four-way controller (▼) in Capture mode.**

The Capture Mode screen appears.

- 2 Use the four-way controller (▲▼◀▶) to select  (Panorama Assist mode).**



- 3 Press the OK button.**
- 4 Use the four-way controller to choose the direction in which the images will be joined.**

- ◀ Joins the images at the left.
- ▶ Joins the images at the right.
- ▲ Joins the images at the top.
- ▼ Joins the images at the bottom.

The example shows the images when ▶ is selected.





## 5 Take the first image.

Press the shutter release button to take the first image. The right edge of the image appears in half-transparent form on the left of the LCD monitor.



## 6 Move the camera to the right and take the second image.

Move the camera until the half-transparent image and the actual view overlap and press the shutter release button. Repeat Steps 5 and 6 to take the third and subsequent images.

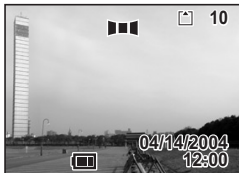

## 7 Press the OK button.

The screen returns to Step 4.



To cancel Panorama Assist mode, change to another mode.



- The camera cannot join the images. Use the panorama software supplied with the camera (ACDSee for PENTAX, ACD Photostitcher). Refer to "Viewing Digital Camera Images on a PC" for instructions on creating panorama pictures.
- Continuous shooting is not possible in Panorama Assist mode.

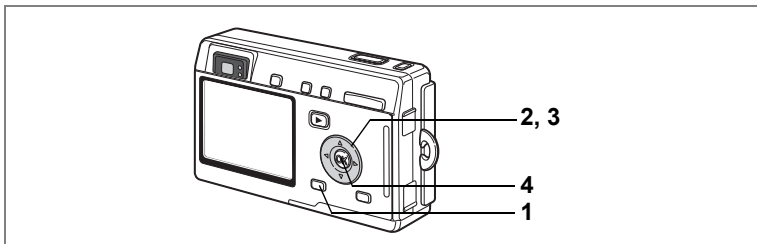

## Taking Soft-Contoured Pictures (Soft Focus Mode)

You can take pictures with a soft lens effect.

- 1 Press the four-way controller (▼) in Capture mode.**

The Capture Mode screen appears.

- 2 Use the four-way controller (▲▼◀▶) to select **SOFT** (Soft Focus mode).**

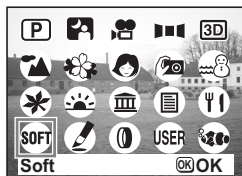

- 3 Press the OK button.**

- 4 Press the shutter release button halfway.**

The focus frame on the LCD monitor will light green when the camera is in focus.

- 5 Press the shutter release button.**

The picture is taken in Soft Focus mode.



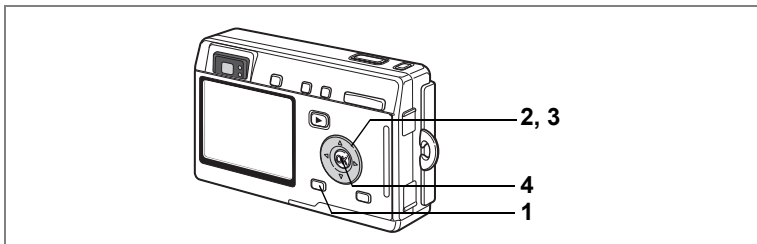

## Taking Posterization-Type Pictures (Posterization Mode)

You can take posterization-type pictures with sharp outlines.

- 1 Press the four-way controller (▼) in Capture mode.**  
The Capture Mode screen appears.
- 2 Use the four-way controller (▲▼◀▶) to select  (Posterization mode).**
- 3 Press the OK button.**
- 4 Press the shutter release button halfway.**  
The focus frame on the LCD monitor will light green when the camera is in focus.
- 5 Press the shutter release button.**  
The picture is taken in Posterization mode.



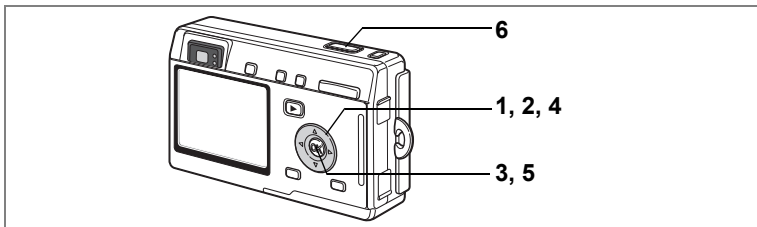

## Taking Pictures with Digital Filters (Digital Filter Mode)

The filters consist of color filters such as red, blue and green, and a slim filter that produces a slim effect. The Digital Filter mode enables you to take pictures using these filters.

### Taking Pictures with the Color Filter

- 1 Press the four-way controller (▼) in Capture mode.**

The Capture Mode screen appears.

- 2 Use the four-way controller (▲▼◀▶) to select  (Digital Filter mode).**

The Color Filter Selection screen appears.

- 3 Press the OK button.**

The Filter Options screen appears.

- 4 Use the four-way controller (▲▼) to choose a color filter.**

You can choose from eight color filters: black-and-white, sepia, red, pink, violet, blue, green and yellow. You can check the filter effect on the LCD monitor when you choose a color.

- 5 Press the OK button.**

- 6 Press the shutter release button halfway.**

The focus frame on the LCD monitor will light green when the camera is in focus.

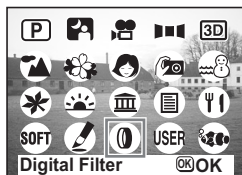

- 7 Press the shutter release button.**

The picture is taken.





## Taking Pictures with the Slim Filter ( )

The screen for setting the slimness level appears when you select the slim filter in Digital Filter mode.

**4 Use the four-way controller (   ) to select  (Slim Filter mode).**

**5 Use the four-way controller (   ) to set the slimness.**

 : Stretches the image up to twice its size horizontally.

 : Stretches the image up to twice its size vertically.

**6 Press the OK button.**

**7 Press the shutter release button halfway.**

The focus frame on the LCD monitor will light green when the camera is in focus.

**8 Press the shutter release button.**

The picture is taken with a slim filter effect.



The digital zoom cannot be used when the slim filter is selected.

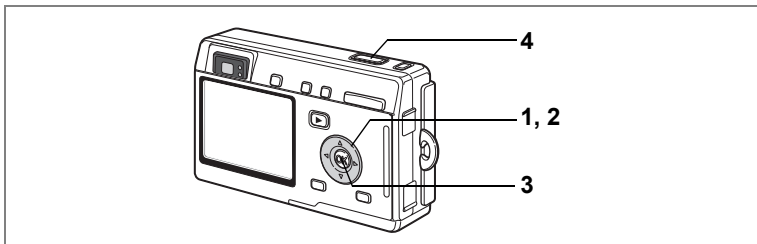

## Using Preset Function Settings (User Mode)

In User mode, you can take pictures using the functions and settings registered in advance in User mode.

### 1 Press the four-way controller (▼) in Capture mode.

The Capture Mode screen appears.

### 2 Use the four-way controller (▲▼◀▶) to select USER (User mode).

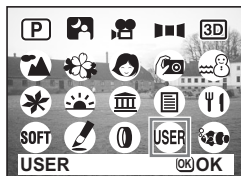

### 3 Press the OK button.

### 4 Press the shutter release button halfway.

The focus frame on the LCD monitor will light green when the camera is in focus.

### 5 Press the shutter release button.

The picture is taken.



Registering Functions in User Mode p.85

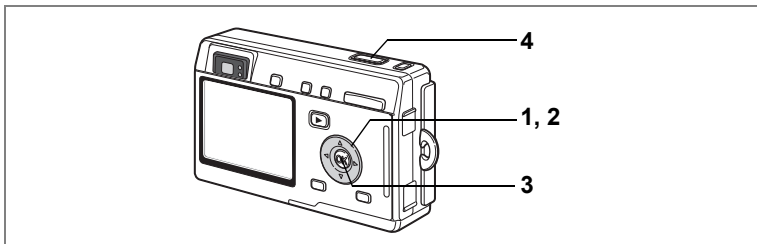

## Taking Underwater Pictures (Marine Mode)

In Marine mode, you can use the optional waterproof case to take underwater pictures that capture the blueness of the sea.

### Taking Underwater Still Pictures (Marine Mode)

- 1 Press the four-way controller (▼) in Capture mode.**

The Capture Mode screen appears.

- 2 Use the four-way controller (▲▼◀▶) to select  (Marine mode).**



- 3 Press the OK button.**

- 4 Press the shutter release button halfway.**

The focus frame on the LCD monitor will light green when the camera is in focus.

- 5 Press the shutter release button.**

The picture is taken.

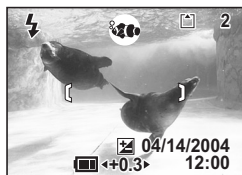

- The only flash modes available are flash on and flash off. Auto flash and the red-eye reduction function are not available.
- Only single-frame or continuous shooting can be selected for the Drive mode. Self-timer mode and remote control mode are not available.
- Only Autofocus or Macro mode can be selected for the focus mode.

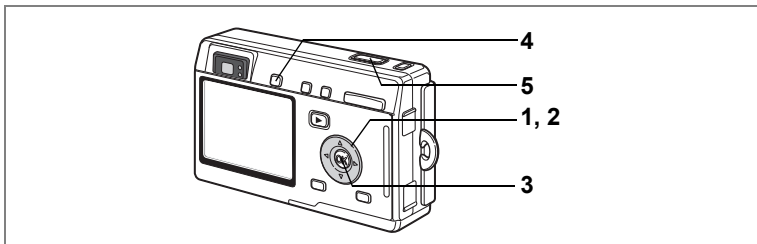

### Taking Underwater Moving Pictures (Marine Moving Picture Mode)

**1 Press the four-way controller (▼) in Capture mode.**

The Capture Mode screen appears.



**2 Use the four-way controller (▲▼◀▶) to select  (Marine mode).**

**3 Press the OK button.**

The Marine Mode screen appears.



**4 Press the QUICK button.**

The camera switches to  (Marine Moving Picture mode). Press the QUICK button again to return to  (Marine mode).

**5 Press the shutter release button.**

The moving picture is recorded.



- Sound cannot be recorded with marine moving pictures.
- In Marine mode, the QUICK button is used solely to switch between Marine mode and Marine Moving Picture mode. In any mode other than Marine mode, pressing the QUICK button activates the function set on [QUICK Button] on the [↑↓ Set-up] menu. (p.122)



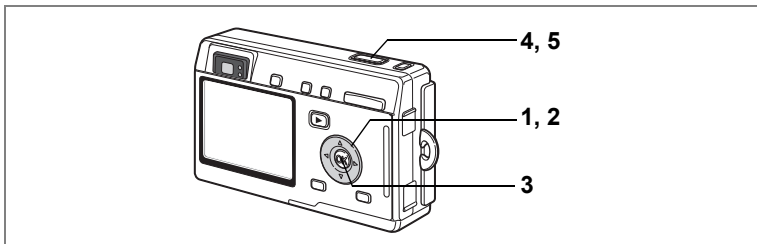

## Taking 3D Pictures (3D Image Mode)

You can take 3D pictures and view them by the parallel method or cross method.

The default setting is [Parallel]. If you print out 3D pictures for viewing by the parallel method and look at them through the optional 3D image viewer, the image will appear in three dimensions.

You can also take 3D pictures for viewing by the cross method. Refer to "Selecting the Viewing Mode" (p.56) for instructions on taking pictures by the cross method.

### 1 Press the four-way controller (▼) in Capture mode.

The Capture Mode screen appears.

### 2 Use the four-way controller (▲▼◀▶) to select 3D (3D Image mode).

### 3 Press the OK button.

The screen for taking the first image appears on the left of the LCD monitor.

### 4 Take the first image.

Hold the camera so that the subject is in the middle of the left half of the screen and press the shutter release button. The image appears in the left half of the LCD monitor. The right half of the screen is for taking the second image.

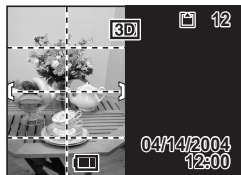

### 5 Move the camera to the right without changing your stance.

### 6 Take the second image.

Make sure that the subject is in the middle of the right half of the screen and press the shutter release button.

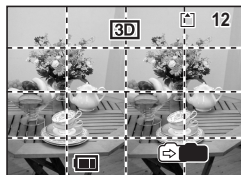

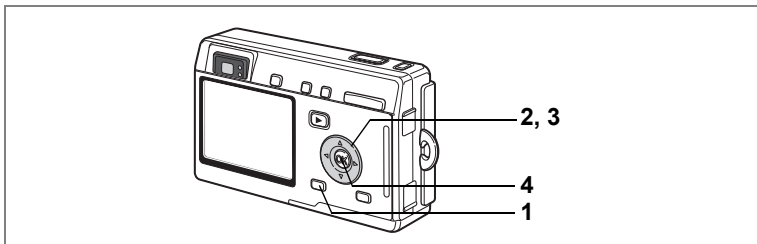

## Selecting the Viewing Mode

### 1 Press the MENU button.

The [Rec.Mode] menu appears.

### 2 Use the four-way controller (▲▼) to select [3D Mode].

### 3 Use the four-way controller (◀▶) to select [Parallel] or [Cross].

To view pictures with the 3D image viewer, select [Parallel].

You can view both [Parallel] and [Cross] pictures without the image viewer.

### 4 Press the OK button.

The camera returns to the Capture Mode screen.

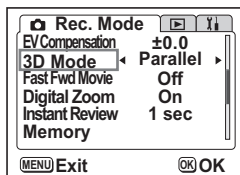

- To cancel the 3D Image mode, change to another Capture mode.
- A three-dimensional effect will not be achieved if the subject moves before the second image is taken. When taking a person, you are recommended to ask your model to stay as still as possible and to take the second picture as quickly as you can. It is easier to take the pictures if you use a tripod or appropriate base.
- As a guide, the camera should be moved about 1/40 of the distance between the camera and the subject. For example, if the subject is 3m away, the distance the camera should be moved will be  $3\text{m} \div 40 = 7.5\text{cm}$ . However, as the way people see three-dimensional images differs from person to person, there is no need to be too concerned. Refer to the table below for a simple guide to how far to move the camera.

Distance to subject	0.1m	0.3m	0.5m	1m	3m	5 m
Camera movement	0.5cm	1cm	1.5cm	2.5cm	7.5cm	13cm

### Viewing 3D Pictures by the Parallel Method and Cross Method

As our eyes are positioned about 6 cm or 7 cm apart, there is a very slight deviation between what we see with our right eye and what we see with our left eye. The difference is processed by our brain to produce a three-dimensional image. This principle is applied to taking and viewing 3D pictures.

3D pictures can be viewed by the parallel method where the left and right lines of vision are virtually parallel, as when looking at a distant scene, or the cross method where the left and right lines of vision are crossed, as when you cross your eyes. A certain amount of practice may be necessary to view 3D pictures without using the viewer.

### How to Assemble the 3D Image Viewer

Assemble the 3D image viewer (optional) as shown below.

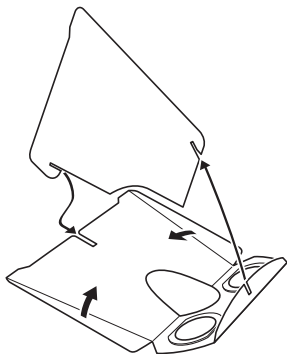

## How to View 3D Pictures Using the 3D Image Viewer

Print out the pictures so that they are about 11 cm or 12 cm wide and place the divider of the 3D image viewer in the middle of the two.

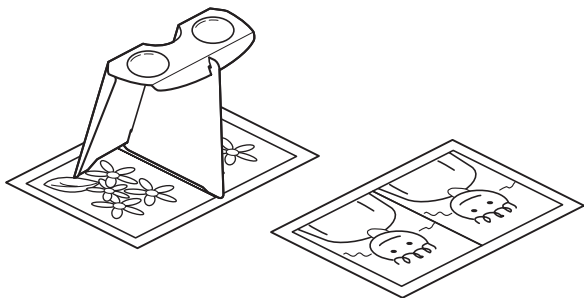

4



As the distance between the left and right eyes differs from person to person, some people may have difficulty obtaining a three-dimensional effect even when looking at prints that are the same size. It may be especially difficult if the pictures are very large or very small. Try different sizes until the right effect is achieved.



- Never look at the sun through the 3D image viewer.
- Do not leave the 3D image viewer where it is exposed to direct sunlight as this may lead to fire.

## Example of a 3D Picture (Cross Method)



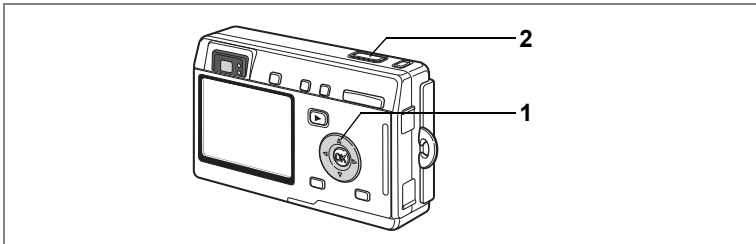

## Using the Self-Timer

In self-timer mode, the picture is taken ten seconds or two seconds after the shutter release button is pressed.

4

Taking Pictures

**1 Press the four-way controller (▲) in Capture mode to display or on the LCD monitor.**

**2 Press the shutter release button.**

- The self-timer is engaged and the self-timer lamp lights for about seven seconds. The picture is taken approximately three seconds after the self-timer lamp starts to blink.



- The self-timer is engaged and the picture is taken approximately two seconds after the self-timer lamp starts to blink.



Focusing may be compromised if you move the camera while the self-timer lamp is blinking.



- The second count appears if you turn the LCD monitor on.
- To cancel the self-timer, press the MENU button while the second count is displayed.
- In 3D Image mode, both the first and second images will be taken with the self-timer engaged.

Taking Pictures of Yourself p.42

Troubleshooting "Subject is not in focus" p.131

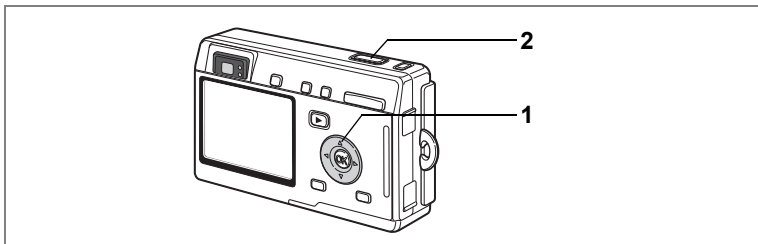

## Using the Remote Control Unit (optional)



You can switch the Drive mode to Remote Control mode and take pictures using the remote control unit (optional).

- 1 Press the four-way controller (▲) in Capture mode to display  or  on the LCD monitor.**

The self-timer lamp blinks slowly and the camera is ready to take the picture.

- 2 Press the shutter release button on the remote control unit.**



-  The self-timer lamp blinks quickly and the picture is taken after approximately three seconds.
-  The picture is taken immediately.



Focusing may be compromised if you move the camera while the self-timer lamp is blinking.



- The buttons on the camera can be used in the normal way.
- Ensure that the remote control unit is no more than four meters away from the front of the camera.

### Life of the Battery for the Remote Control Unit

A signal can be sent from the remote control unit to the camera approximately 30,000 times. Contact your nearest PENTAX customer service center if the battery needs changing. (A charge is made for changing the battery.)

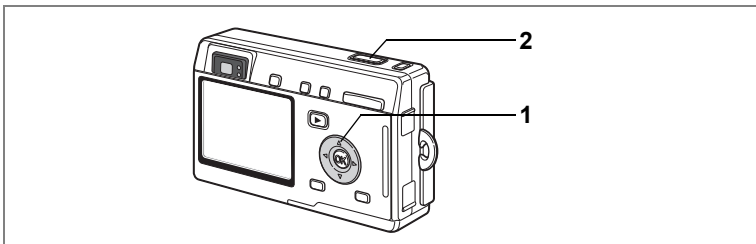

## Continuous Shooting (Continuous Shooting Mode)

4

Taking Pictures

You can switch the Drive mode to Continuous Shooting mode. Pictures are taken continuously while the shutter release button is pressed.

**1 Press the four-way controller (▲) in Capture mode to display  on the LCD monitor.**

**2 Press the shutter release button halfway.**

The focus frame on the LCD monitor will light green when the camera is in focus.

**3 Press the shutter release button.**

Pictures are taken continuously while the shutter release button is pressed.

Shooting stops when you take your finger off the shutter release button.

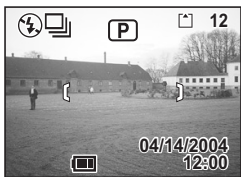

- You can continue shooting until the SD Memory Card is full.
- The interval will vary according to the [Recorded Pixels] and [Quality Level] settings.



- The flash will not discharge in Continuous Shooting mode.
- Continuous shooting is not available for Moving Picture, Panorama Assist or 3D Image mode.
- The focus, exposure and white balance are locked with the first image.



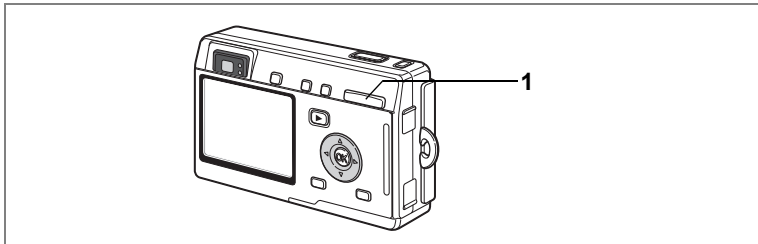

## Using the Zoom

You can use the zoom to change the size of the subject and take pictures in Tele or Wide mode.

### 1 Press the Zoom button in Capture mode.

▲ : makes the subject bigger.

▼ : makes the subject smaller.

When the digital zoom function is disabled, you can take pictures at up to three times magnification using the optical zoom. When the digital zoom function is enabled, you can further enlarge the subject to a maximum magnification equivalent to 12 times.

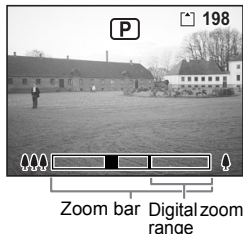

Zoom bar Digital zoom range

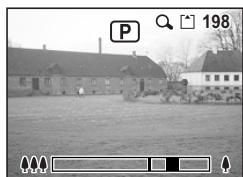

When digital zoom is enabled

Saving the Zoom Position p.84



You cannot use the optical zoom in Moving Picture mode.

## Enabling the Digital Zoom Function

### 1 Press the MENU button in Capture mode.

The [Rec.Mode] menu appears.

### 2 Use the four-way controller (▲▼) to select [Digital Zoom].

### 3 Use the four-way controller (◀▶) to select [On].

### 4 Press the OK button.

The camera is ready to take the picture.

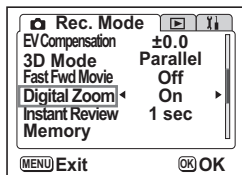

4

Taking Pictures



- The digital zoom is disabled when you turn the LCD monitor off, even if the digital zoom function is set to On.
- You cannot use the digital zoom if the slim filter has been selected for the digital filter.



You should compose the picture on the LCD monitor when you use the digital zoom function.

Saving the Digital Zoom Function Setting p.84

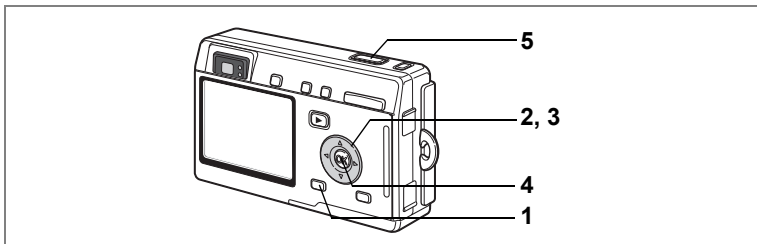

## Taking Time-Lapse Moving Pictures

This mode lets you take moving pictures at a delayed frame rate so that when you play the moving picture back, the action appears speeded up.

- 1 Press the MENU button in Moving Picture mode or Marine Moving Picture mode.**  
The [📷 Rec.Mode] menu appears.
- 2 Use the four-way controller (▼) to select [Time-Lapse Movie].**
- 3 Use the four-way controller (◀▶) to choose [Off (×1)], [×2], [×5], [×10], [×20], [×50] or [×100].**
- 4 Press the OK button.**
- 5 Press the shutter release button.**

Shooting in Time-Lapse Movie mode starts.

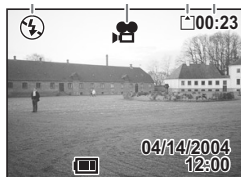

- Off (×1) is the normal setting for moving pictures (15 frames per second). Each time ×2 or ×5 is selected, the number of frames taken per second is reduced to 1/2 or 1/5.
- As moving pictures are normally played back at the rate of 15 frames per second, moving pictures taken at ×2 appear to be played back at twice the normal speed and moving pictures taken at ×5 appear to be played back at five times the normal speed.
- Sound cannot be recorded.

Taking Moving Pictures 📷p.44



Taking Underwater Moving Pictures 📷p.54

# Setting the Shooting Functions

## Changing the Mode

Capture mode is for taking pictures and Playback mode is for playing back or deleting images.











### Switching between Capture Mode and Playback Mode







- To change from Capture mode to Playback mode, press the  Playback button.
- To change from Playback mode to Capture mode, press the  Playback button or press the shutter release button halfway.

## Selecting the Capture Mode

Pressing the QUICK button activates the Green mode. Other capture modes are selected from the Capture Mode screen.

### Capture Modes

	Green mode	Lets you take pictures quickly and easily.	p.40	
	Program mode	The basic picture-taking mode.	p.41	
	Night-Scene mode	Lets you take dark scenes such as night views.	p.43	
	Moving Picture mode	Lets you take moving pictures and sound.	p.44	
	Panorama Assist mode	Lets you take a number of images to be joined into a panorama picture using the software supplied with the camera.	p.46	
	3D Image mode	Lets you take 3D pictures.	p.55	
	Picture mode	Landscape mode	Lets you capture the natural colors of landscape views.	p.42
		Flower mode	Lets you take brightly colored flower pictures.	
		Portrait mode	Lets you take portraits with spatial effect, by emphasizing the person.	
		Self-Portrait mode	Lets you take pictures of yourself or be included in pictures.	
		Surf & Snow mode	Lets you take photos against dazzling backgrounds like beaches or snow-covered mountains.	

*	Picture mode	Autumn Colors mode	Lets you take colorful pictures of trees in autumn.	p.42
		Sunset mode	Lets you reproduce the beautiful colors of the sunrise or sunset.	
		Museum mode	Lets you take pictures of works of art in museums and art galleries.	
		Text mode	Lets you take clear pictures of text or writing.	
		Food mode	Lets you take appetizing pictures of prepared food.	
<b>SOFT</b>	Soft Focus mode	Lets you take pictures with a soft lens effect.	p.48	
	Posterization mode	Lets you take posterization-type pictures with sharp outlines.	p.49	
	Digital Filter mode	Lets you take pictures with a color filter or slim filter.	p.50	
<b>USER</b>	USER mode	Lets you activate the preset function settings simply by turning the camera on.	p.52	
	Marine mode	Lets you take underwater pictures that capture the blueness of the sea using the waterproof case.	p.53	

## Selecting the Green Mode

### 1 Press the QUICK button.

You can switch straight to the Green mode from the Capture mode, Playback mode or menu screens.



You cannot switch to the Green mode using the QUICK button if a different function has been assigned to the QUICK button. (p.122)

## Selecting a Capture Mode other than the Green Mode

### 1 Press the four-way controller (▼) in Capture mode.

The Capture Mode screen appears.

### 2 Use the four-way controller (▲▼◀▶) to choose the icon for the mode you want to set.

The icon is surrounded by a green frame.

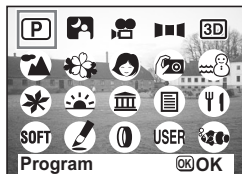

### 3 Press the OK button.

The camera is ready to take pictures in the selected mode.

## Displaying Shooting Information in Capture Mode

You can display shooting information on the LCD monitor when taking pictures. The display mode can be changed by pressing the DISPLAY button.

### Display On

Shooting information is displayed when the power is turned on.

- |   |                        |
|---|------------------------|
| 1 Flash mode                            | 2 Drive mode           |
| 3 Focus mode                            | 4 Capture mode         |
| 5 Focus frame                           | 6 Card/Built-in memory |
| 7 Remaining number of recordable images | 8 Date and time        |
| 8 Date and time                         | 9 Battery indicator    |
| 10 Aperture                             | 11 Shutter speed       |

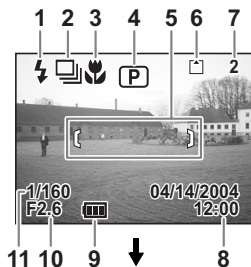

### Histogram Display

The brightness distribution of the image is displayed. The horizontal axis shows the brightness (darkest at the left end and brightest at the right end) and the vertical axis shows the number of pixels.

- |                 |                   |
|-----------------|-------------------|
| 1 Histogram     | 2 Recorded pixels |
| 3 Quality level | 4 White balance   |
| 5 AE metering   | 6 Sensitivity     |

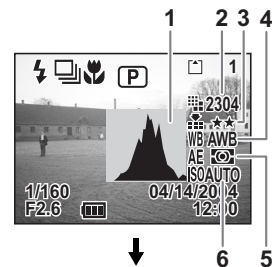

### Display Off

No shooting information is displayed.

- The focus frame appears in Autofocus mode.
- If any of the modes are changed, such as the flash mode, the mode you have changed appears for a few seconds.



### LCD Monitor Off

The LCD monitor turns off.



- The display cannot be turned off in , , , or mode.
- The histogram cannot be displayed in mode.



Saving the Display Mode p.84

Display On

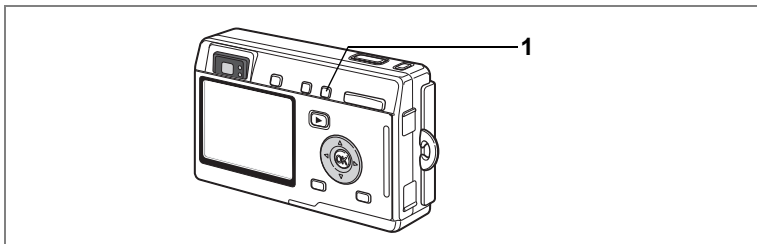

## Selecting the Focus Mode

### Focus mode

(No icon)	Autofocus mode	The camera focuses on the object in the autofocus area when the shutter release button is pressed halfway. Use this mode when the distance to the subject is more than 40 cm (16 in.).
	Macro mode	This mode is used when the distance to the subject is approx. 18 cm – 50 cm (7 in. – 20 in.). The camera focuses on the object in the autofocus area when the shutter release button is pressed halfway.
	Super Macro mode	This mode is used when the distance to the subject is approx. 6 cm – 20 cm (2.4 in. – 8 in.). The camera focuses on the object in the autofocus area when the shutter release button is pressed halfway.
	Infinity-Landscape mode	This mode is used for taking distant objects.
<b>MF</b>	Manual Focus mode	Adjust the focus manually with the four-way controller.
	Focusing Area mode	The position of the autofocus area is changed.

Saving the Focus Mode p.84

### 1 Press the MF button in Capture mode.

The focus mode changes each time the button is pressed and the icon appears on the LCD monitor.

The camera is ready to take pictures in the selected focus mode.



- The default setting is Autofocus mode.
- The zoom is fixed at the middle position and only the digital zoom can be used in Super Macro mode.
- Only Autofocus, Infinity-Landscape and Manual Focus modes can be selected in Moving Picture mode ( p.44).
- The flash does not fire in Super Macro mode.



If you take a picture while looking through the viewfinder when the focus mode is set to Macro or Super Macro, the range of the resulting picture will differ from what was seen in the viewfinder. Be sure to check the image on the LCD monitor.

## Manual Focus

When the mode is set to **MF** (Manual Focus), the central portion of the picture is enlarged to full screen on the LCD monitor for focus adjustment. Use the four-way controller (**▲▼**) to adjust the focus while watching the indicator on the LCD monitor.



For distant focus



For closer focus



Indicator

After the focus is set, press any button except the four-way controller (**▲▼**) or take your finger off the four-way controller (**▲▼**). The screen returns to the normal display about two seconds later.



When focusing, hold down the four-way controller (**▲▼**) to focus quickly.

## Changing the Focusing Point

In Autofocus mode, you can change the focusing point by moving the focus frame.

- 1** In **AF** (Focusing Area) mode, press the four-way controller (**▲▼◀▶**).

Moves the focus frame [ ] (Focusing area).

- 2** Press the shutter release button halfway.

The focus frame is fixed in its new position.

To return the focus frame to its original location, press the **MF** button again.

Troubleshooting "Subject is not in focus" p.131



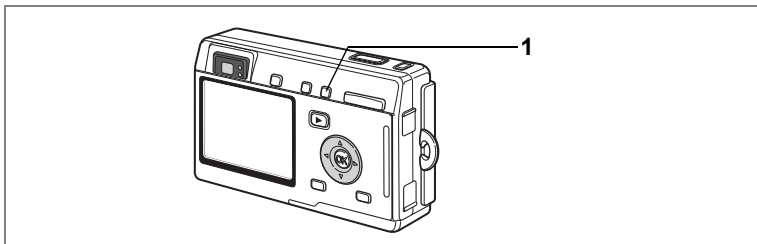

## Selecting the Flash Mode

### Flash Modes

(No icon)	Auto	The flash discharges automatically depending on the light conditions.
	Flash off	The flash will not discharge, regardless of the brightness. Use this mode to take pictures at dusk or in museums etc. where flash photography is prohibited.
	Flash on	The flash discharges regardless of the brightness.
	Auto + red-eye reduction	This mode reduces the phenomenon of red eyes caused by the light from the flash being reflected in the subject's eyes. The flash discharges automatically.
	Flash On + red-eye reduction	This mode reduces the phenomenon of red eyes caused by the light from the flash being reflected in the subject's eyes. The flash will discharge regardless of lighting conditions.



- The flash is off when the Capture mode is set to (Moving Picture Mode), (Marine Moving Picture mode), Continuous Shooting or Infinity-Landscape mode.
- The flash discharges a total of three times, two pre-flashes and the third time to take the picture. (In the red-eye reduction modes, the interval between the pre-flashes and the main flash is longer.)

### 1 Press the button in Capture mode.

The flash mode changes each time the button is pressed and the icon appears on the LCD monitor.

The camera is ready to take pictures in the selected flash mode.

Status of the Focus Status Lamp and Flash Status Lamp p.27

Saving the Flash Mode p.84



Using the flash in Macro mode may cause the image to be overexposed.

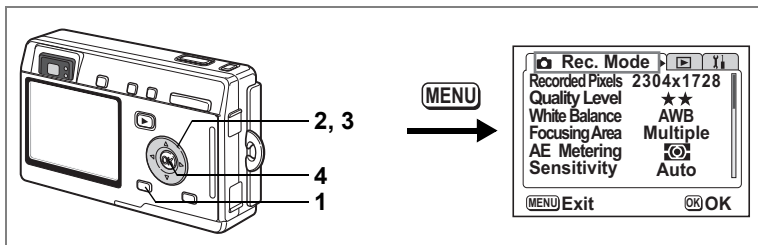

## Selecting the Recorded Pixels

You can choose the number of recorded pixels from [2304×1728], [1600×1200], [1024×768] and [640×480].

The more pixels there are, the larger the picture and the bigger the file size. The data volume also varies depending on the quality level setting (see p.73).

### Number of Recorded Pixels

2304×1728	Suitable for printing on A4 paper (8 1/2 in. × 11 1/2 in.)
1600×1200	Suitable for printing on A5 paper
1024×768	Suitable for printing on postcards
640×480	Suitable for attaching to e-mails or creating websites

#### 1 Press the MENU button in Capture mode.

The [Rec.Mode] menu appears.

#### 2 Use the four-way controller (▲▼) to select [Recorded Pixels].

#### 3 Use the four-way controller (◀▶) to change the size.

#### 4 Press the OK button.

The camera is ready to take the picture.

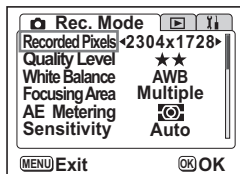

- The number of recorded pixels is fixed at 320×240 in the Moving Picture mode.
- Selecting a large size produces a clear picture when it is printed out.
- The Recorded Pixels setting is saved when the camera is turned off.

Image Size and Quality see p.22

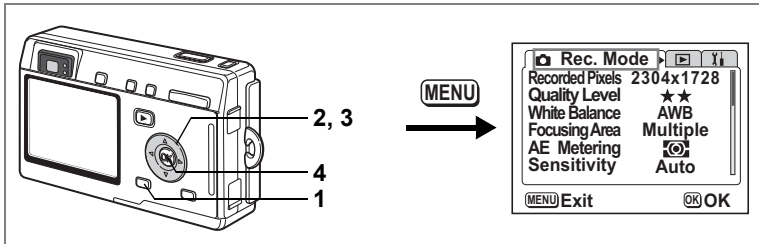

## Selecting the Quality Level

You can choose the image compression ratio. The more stars, the clearer the quality and the larger the volume. The recorded pixels setting also changes the picture volume (p.72).

### Quality Levels

★★★	Best	Lowest compression ratio. Suitable for photo prints.
★★	Better	Standard compression ratio. Suitable for viewing the image on a computer screen.
★	Good	Highest compression ratio. Suitable for attaching to e-mails or creating websites.

- 1 Press the MENU button in Capture mode.**  
The [📷 Rec.Mode] menu appears.
- 2 Use the four-way controller (▲▼) to select [Quality Level].**
- 3 Use the four-way controller (◀▶) to change the quality level.**
- 4 Press the OK button.**  
The camera is ready to take the picture.

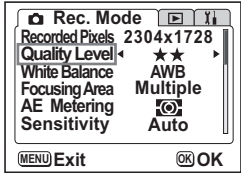

The Quality Level setting is saved when the camera is turned off.

Image Size and Quality p.22

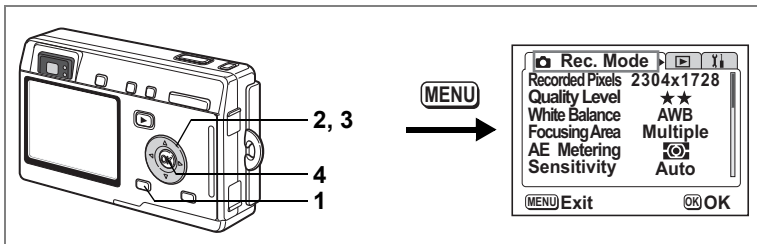

## Adjusting the White Balance

You can take pictures in natural colors by selecting the white balance best suited to the light conditions at the time of shooting.

4

Taking Pictures

### White Balance

<b>AWB</b>	Auto	The camera adjusts the white balance automatically.
	Daylight	Use this mode when taking pictures outside in sunlight.
	Shade	Use this mode when taking pictures outside in the shade.
	Tungsten Light	Use this mode when taking pictures under electric or other tungsten light.
	Fluorescent Light	Use this mode when taking pictures under fluorescent light.
	Manual	Use this mode when taking pictures by adjusting the white balance manually.

- 1 Press the MENU button in Capture mode.**  
The [Rec.Mode] menu appears.
- 2 Use the four-way controller (▲▼) to select [White Balance].**
- 3 Press the four-way controller (▶).**  
The White Balance screen appears.
- 4 Use the four-way controller (▲▼) to change the setting.**
- 5 Press the OK button twice.**  
The camera is ready to take the picture.



Saving the White Balance p.84

## Manual Setting

Have a blank sheet of white paper ready.

- 1 Select [ ] (manual) on the White Balance screen.**
- 2 Point the camera at the blank sheet of paper so that it fills the screen.**
- 3 Press the DISPLAY button.**

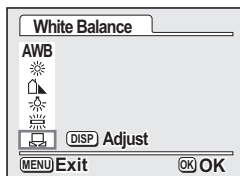

The white balance is automatically adjusted. [Complete] appears on the LCD monitor and the display returns to the menu screen.

- 4 Press the OK button.**

The camera is ready to take the picture.

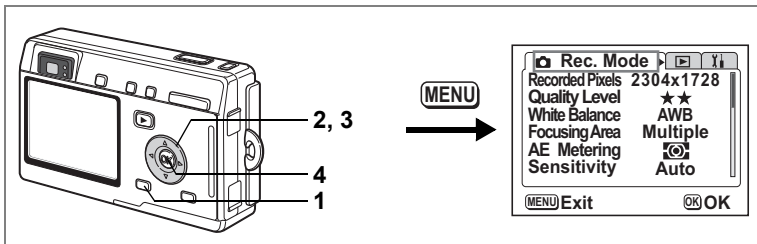

## Changing the Focusing Area

You can change the autofocus area (Focusing Area).

4

### Focusing Area

Multiple	Normal range
Spot	The autofocus range becomes smaller.

#### 1 Press the MENU button in Capture mode.

The [📷 Rec.Mode] menu appears.

#### 2 Use the four-way controller (▲▼) to select [Focusing Area].

#### 3 Use the four-way controller (◀▶) to change the setting.

#### 4 Press the OK button.

The camera is ready to take the picture.

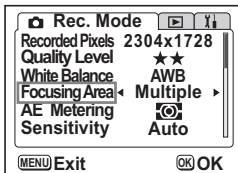

The autofocus area does not appear in the viewfinder. Always check the focusing area on the LCD monitor.

Saving the Focusing Area Setting p.84

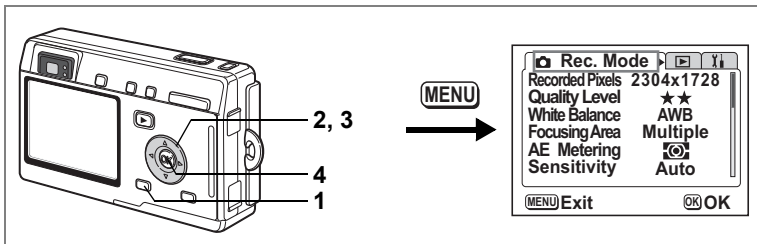

## Setting the Light Metering Range to Determine the Exposure

You can choose which part of the screen to use to measure the brightness and determine the exposure.

### AE Metering Modes

	Multi-segment	The exposure is determined by the entire screen.
	Center-weighted	The exposure is determined mainly by the center of the screen.
	Spot	The exposure is determined by the small area in the center of the screen only.

#### 1 Press the MENU button in Capture mode.

The [Rec.Mode] menu appears.

#### 2 Use the four-way controller (▲▼) to select [AE Metering].

#### 3 Use the four-way controller (◀▶) to change the AE metering mode.

#### 4 Press the OK button.

The camera is ready to take the picture.

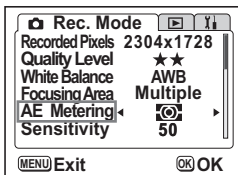

When is selected, the AE metering point moves in correspondence with movement of the focusing area. (p.70)

Saving the AE Metering Mode p.84

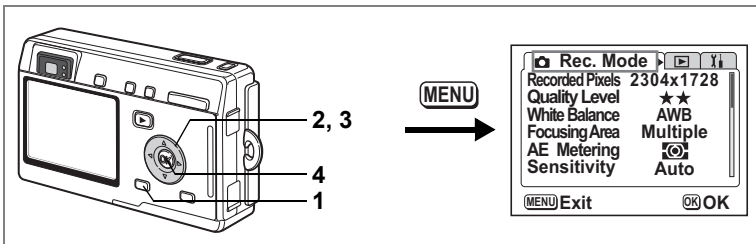

## Setting the Sensitivity

You can select the sensitivity to suit the brightness of the surroundings.

4

Taking Pictures

### Sensitivity

Auto	The camera sets the sensitivity automatically.
50	<ul style="list-style-type: none"> <li>The lower the sensitivity, the sharper the image and the less noise. The shutter speed will be slower in low light conditions.</li> <li>The higher the sensitivity, the faster the shutter speed in low light conditions to reduce camera shake, but the image may be affected by noise.</li> </ul>
100	
200	

#### 1 Press the MENU button in Capture mode.

The [Rec.Mode] menu appears.

#### 2 Use the four-way controller (▲▼) to select [Sensitivity].

#### 3 Use the four-way controller (◀▶) to change the sensitivity.

#### 4 Press the OK button.

The camera is ready to take the picture.

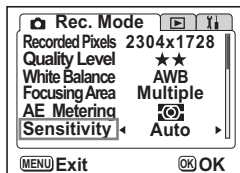

Saving the Sensitivity p.84



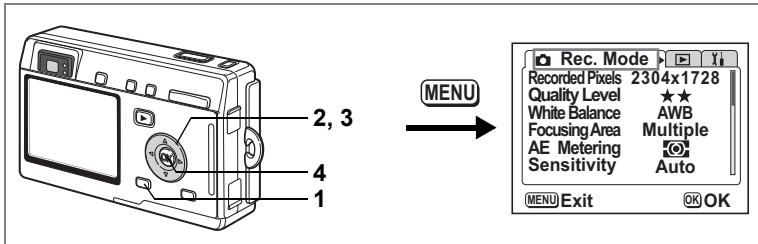

## Setting the Instant Review Time

You can choose the Instant Review time from 0.5 sec., 1 sec., 2 sec., 3 sec., 4 sec., 5 sec. and Off (no display).

### 1 Press the MENU button in Capture mode.

The [Rec.Mode] menu appears.

### 2 Use the four-way controller (▲▼) to select [Instant Review].

### 3 Use the four-way controller (◀▶) to change the display time.

### 4 Press the OK button.

The camera is ready to take the picture.

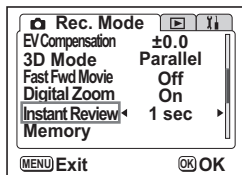

The Instant Review setting is saved when the camera is turned off.

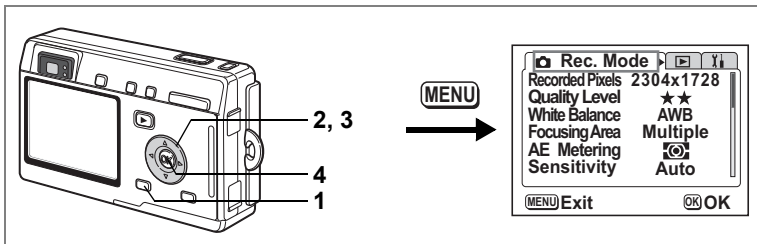

## Setting the Image Sharpness

You can choose whether you want the image to have sharp or soft outlines.

4

Taking Pictures

### 1 Press the MENU button in Capture mode.

The [Rec.Mode] menu appears.

### 2 Use the four-way controller (▲▼) to select [Sharpness].

### 3 Use the four-way controller (◀▶) to change the setting from [Normal] to [Hard (+)] or [Soft (-)].

### 4 Press the OK button.

The camera is ready to take the picture.

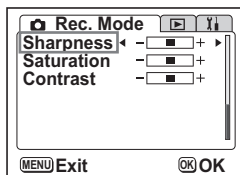

The Sharpness setting is saved when the camera is turned off.



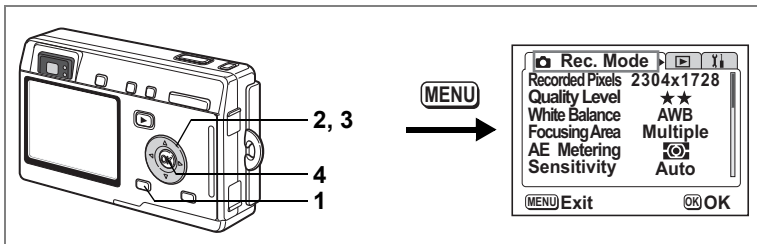

## Setting the Image Contrast

You can set the image contrast.

- 4 **1 Press the MENU button in Capture mode.**

The [Rec.Mode] menu appears.

- 2 Use the four-way controller (▲▼) to select [Contrast].**

- 3 Use the four-way controller (◀▶) to change the setting from [Normal] to [High (+)] or [Low (-)].**

- 4 Press the OK button.**

The camera is ready to take the picture.

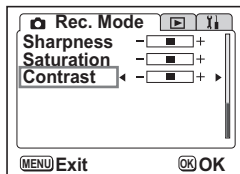

The Contrast setting is saved when the camera is turned off.

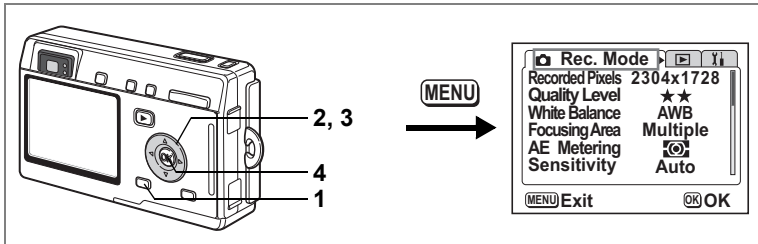

## Setting the Exposure (EV Compensation)

You can adjust the overall brightness of the picture. Use this function to take pictures that are intentionally overexposed or underexposed.

### 1 Press the MENU button in Capture mode.

The [Rec.Mode] menu appears.

### 2 Use the four-way controller (▲▼) to select [EV Compensation].

### 3 Use the four-way controller (◀▶) to change the EV setting.

To brighten, set a positive (+) value. To darken, set a negative (-) value.

You can choose the EV setting in the range of -2.0 EV to +2.0 EV in 1/3 EV steps.

### 4 Press the OK button.

The camera is ready to take the picture.

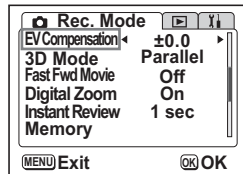

EV Compensation is registered on the four-way controller (◀▶) in the Custom Function default settings in Capture mode, enabling you to change the EV setting without displaying the menu (c.p.121).











The AE metering mode is either center-weighted or spot when the EV setting is adjusted.

Saving the EV Compensation Value c.p.84

# Saving the Settings

## Saving the Menu Items (Memory)

You can choose whether you want the set values to be saved when the camera is turned off. If you select  (On), the settings will be saved in the status they were in immediately before the camera was turned off. If you select  (Off), the settings will be reset to the defaults when the camera is turned off.

Item	Description	Default Setting
Flash	The flash mode setting on the  button is saved.	<input checked="" type="checkbox"/>
Drive	The drive mode setting (  ) selected using the four-way controller (  ) is saved.	<input type="checkbox"/>
Focus Mode	The focus mode setting on the  MF button is saved.	<input type="checkbox"/>
Zoom Position	The optional zoom position setting on the Zoom button is saved.	<input type="checkbox"/>
MF	The manual focus position is saved.	<input type="checkbox"/>
White Balance	The [White Balance] setting on the [  Rec.Mode] menu is saved.	<input type="checkbox"/>
AE Metering	The [AE Metering] setting on the [  Rec.Mode] menu is saved.	<input type="checkbox"/>
Sensitivity	The [Sensitivity] setting on the [  Rec.Mode] menu is saved.	<input type="checkbox"/>
EV Compensation	The [EV Compensation] setting on the [  Rec.Mode] menu is saved.	<input type="checkbox"/>
Digital Zoom	The [Digital Zoom] setting on the [  Rec.Mode] menu is saved.	<input checked="" type="checkbox"/>
Display	The LCD monitor display mode is saved.	<input type="checkbox"/>
File No.	The file number is saved. If a new SD Memory Card is inserted, file numbers are assigned sequentially.	<input checked="" type="checkbox"/>



- Menu items not included in [Memory] will also be saved in the settings selected on the menus for each function when the camera is turned off.
- The zoom position setting in the digital zoom range will not be saved even if [Zoom Position] is set to  (On) in [Memory].
- [Memory] can be set separately in User mode and other capture modes.

# 1 Press the MENU button in Capture mode.

The [Rec.Mode] menu appears.

# 2 Use the four-way controller (▲▼) to select [Memory].

# 3 Press the four-way controller (▶).

The [Memory] menu appears.

# 4 Use the four-way controller (▲▼) to choose an item.

# 5 Use the four-way controller (◀▶) to select (On) or (Off).

# 6 Press the OK button twice.

The camera is ready to take the picture.

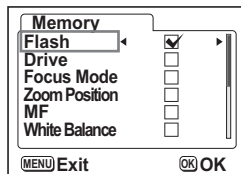
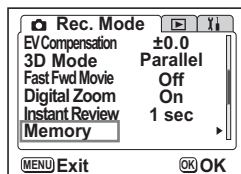

## Registering Functions in User Mode

Functions set with the Capture mode on **USER** will be registered in User mode.

### Functions Registered in User Mode

Items Registered in User Mode	Default Setting	Page
Flash mode	Auto	p.71
Drive mode	Normal	p.61 – 62
Focus mode	Autofocus	p.69
Manual focus position	Infinity	p.70
Recorded pixels	2304×1728	p.72
Quality	★★	p.73
White balance	AWB (auto)	p.74
Focusing area	Multiple	p.76
AE metering	(Multi-segment)	p.77
Sensitivity	Auto	p.78
Digital zoom	On	p.63
Instant review	1 sec.	p.79
Memory	All On	p.84
Sharpness	Normal	p.80
Saturation	Normal	p.81
Contrast	Normal	p.82
EV compensation	±0.0	p.83
Custom function	EV compensation	p.121

## Recording Sound (Voice Recording Mode)

You can record sound. The recordable time appears on the LCD monitor according to how much space is available on the SD Memory Card.

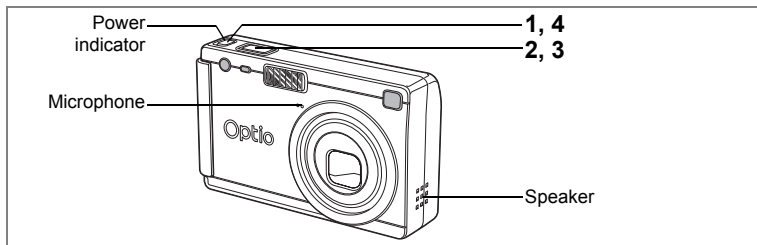

- 1 Press the power switch for more than two seconds, or press the power switch while pressing the DISPLAY button.**

The power indicator lights red.

The recordable time appears on the LCD monitor.

1 Remaining recordable time

2 Recording time

- 2 Press the shutter release button.**

Recording starts. The self-timer lamp and flash status lamp light during recording.

When the shutter release button is pressed for more than one second, recording continues for as long as the button is held down and stops when the button is released.

- 3 Press the shutter release button.**

Recording stops. The remaining recordable time appears.

- 4 To exit Voice Recording mode, turn the camera off.**

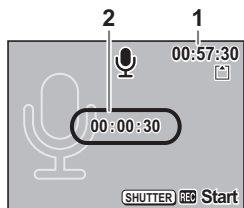

-  memo
- When you press the power switch, the lens extends, then retracts immediately and the camera enters the Voice Recording mode.
  - Sound is saved in WAVE monaural files.
  - The microphone is located on the front of the camera. Aim the camera to obtain the best sound.
  - An index can be added by pressing the MENU button during recording.



# Playing Back Sound

You can play back the recording you made in Voice Recording mode.

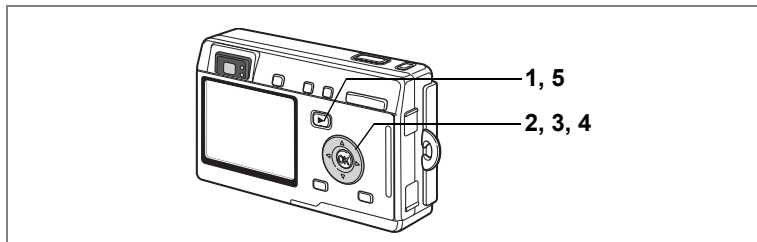

**1 Press the  Playback button in the Voice Recording mode.**

**2 Use the four-way controller ( ) to choose the recording to play back.**

**3 Press the four-way controller ().**  
Playback starts.



• **The following operations can be performed during playback.**

Four-way controller () Pauses playback  
Press again to resume playback



If there are no recorded indexes:

Four-way controller () Rewinds five seconds  
Four-way controller () Advances five seconds

If there are recorded indexes:

Four-way controller () Plays back starting from the previous index  
Four-way controller () Plays back starting from the next index

Zoom//Q button () Increases the volume

Zoom//Q button () Reduces the volume

**4 Press the four-way controller () .**

Playback stops.

**5 Press the  Playback button.**

The camera switches to the Voice Recording mode.



If you entered the Playback mode from Capture mode, the camera will switch to Capture mode in Step 5. To continue recording, turn the camera off, then turn it on again in the Voice Recording mode. (p.31)

# Adding a Voice Memo

You can add a voice memo to a captured image.

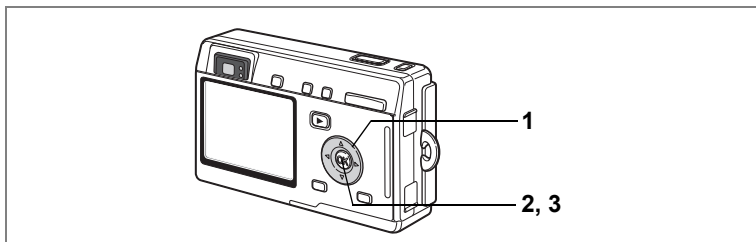

- 1 Enter the Playback mode and use the four-way controller (◀▶) to choose the image to which you want to add a voice memo.**

The voice memo screen appears on the LCD monitor while the image is displayed.



- 2 Press the OK button.**

Recording starts. You can record for up to 30 seconds.

- 3 Press the OK button.**

Recording stops.



- [ ] appears on the screen when a voice memo is added.
- A voice memo cannot be added to an image which already has a voice memo. Delete the old voice memo and record a new one. (p.96)



A voice memo cannot be added to protected ( ) images.

## Setting the Record Voice Memo to [Off]

- 1 Select [Record Voice Memo] on the [▶] Playback menu.**
- 2 Use the four-way controller (◀▶) to select [Off].**
- 3 Press the OK button.**

disappears from the four-way controller guide and no voice memos can be added.

## Playing Back Images

You can play back images recorded on the SD Memory Card when a card is inserted in the camera, or in the built-in memory when no card is inserted.

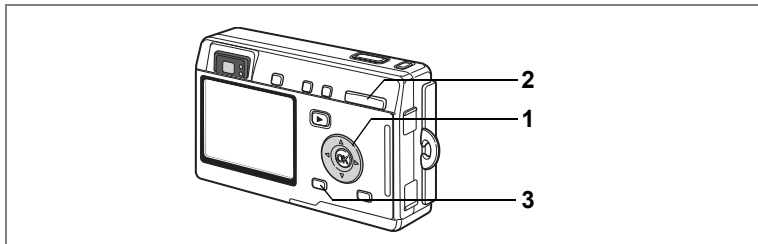

### Playing Back Still Pictures

Press the Playback button.

Refer to “Playing Back an Image” (p.28), or “Playing Back the Previous or Next Image” (p.28) for instructions on playing back images.

### Zoom Display

You can display images magnified up to four times. A guide to operation appears on the LCD monitor during magnification. (The magnification varies depending on the size of the image.)

- 1 Enter the Playback mode and use the four-way controller (◀▶) to choose the image to magnify.**
- 2 Press on the Zoom/ button.**

The image is magnified (1× to 4×). Holding down the button changes the magnification continuously.

- **The following operations can be performed while the magnified image is displayed.**

Four-way controller (▲▼◀▶)	Moves the position to be magnified
Zoom/ button (▲)	Makes the image bigger
Zoom/ button (◆◆◆)	Makes the image smaller
DISPLAY button	Turns the guide marks on/off



### 3 Press the MENU button.

Zoom playback ends.



Moving pictures cannot be magnified.

#### Setting the Quick Zoom Function

You can display the image at maximum magnification simply by pressing the Zoom// button once during zoom playback.

- 1 Select [Quick Zoom] on the [ Playback] menu.**
- 2 Use the four-way controller (◀▶) to select [On] or [Off].**
  - On : Pressing of the Zoom// button once displays the image at maximum magnification
  - Off : Pressing of the Zoom// button once magnifies the image in steps
- 3 Press the OK button.**

The camera is ready to take or play back images.

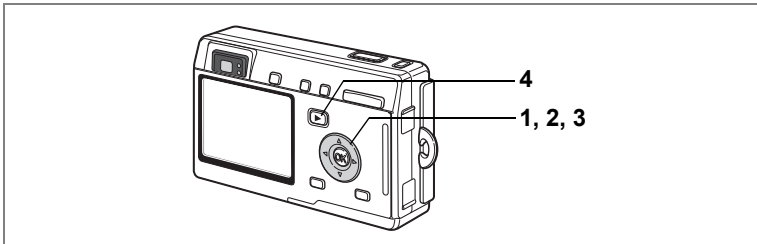

## Playing Back Moving Pictures

You can play back moving pictures. You can play back the recording you made in Voice Recording mode at the same time. A guide to operation appears on the LCD monitor during playback. Operations include playback, frame by frame playback (forward or reverse), pause and volume adjustment.

**1 Enter the Playback mode and use the four-way controller (◀▶) to choose the moving picture to play back.**

**2 Press the four-way controller (▲).**  
Playback starts.

• **The following operations can be performed during playback.**

- Four-way controller (◀) Reverse playback
- Four-way controller (▶) Forward playback
- Four-way controller (▲) Pause
- DISPLAY button Changes the display mode (p.92)
- Zoom button ▲▲▲/▲ Adjusts the volume



• **The following operations can be performed while Pause is engaged.**

- Four-way controller (◀) Frame reverse
- Four-way controller (▶) Frame forward
- Four-way controller (▲) Releases the Pause function
- DISPLAY button Changes the display mode (p.92)

**3 Press the four-way controller (▼).**  
Playback stops and the screen returns to the first frame.

**4 Press the [▶] Playback button.**  
The camera returns to Capture mode.

## Displaying Shooting Information in Playback Mode

Shooting information can be displayed on the LCD monitor in Playback mode. Pressing the DISPLAY button changes the display mode.

### Display On

Shooting information is displayed.

- |                                       |                   |
|---------------------------------------|-------------------|
| 1 Protect icon                        | 2 Voice Memo icon |
| 3 Folder name                         | 4 File name       |
| 5 Card/Built-in memory icon           |                   |
| 6 Four-way controller operation guide |                   |
| 7 Shooting date and time              |                   |
| 8 Battery indicator                   |                   |

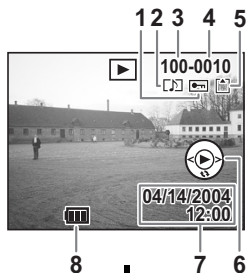

### Histogram Display

The brightness distribution of the image is displayed. The horizontal axis shows the brightness (darkest at the left end and brightest at the right end) and the vertical axis shows the number of pixels.

- |                 |                   |
|-----------------|-------------------|
| 1 Histogram     | 2 Recorded pixels |
| 3 Quality level | 4 White balance   |
| 5 AE metering   | 6 Sensitivity     |
| 7 Aperture      | 8 Shutter speed   |

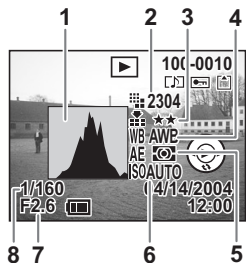

### Display Off

No shooting information is displayed.



Display On

Saving the Display Mode p.84

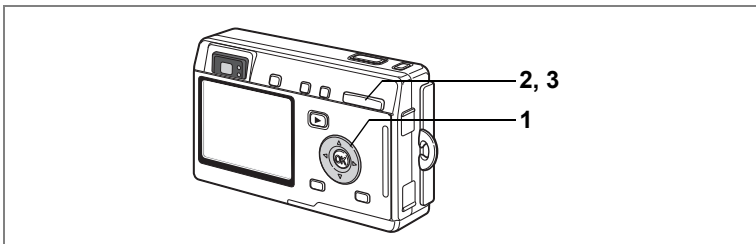

## Nine Image Display

You can display nine images at the same time.

- 1** Enter the Playback mode and use the four-way controller (◀▶) to choose an image.
- 2** Press ▲▲/⏮ on the Zoom/⏮/Q button.

Nine images appear with the selected image in the center.

Use the four-way controller (▲▼◀▶) to choose an image. When ten or more images have been recorded, the previous nine images appear when you press the four-way controller (◀) while an image on the left row is selected. Similarly, the next nine images appear when you press the four-way controller (▶) while an image on the right row is selected.



Selected image

- 3** Press ▲▲/⏮ on the Zoom/⏮/Q button.

The screen returns to full screen display of the selected image.



Pressing the MENU button, ⏻ button or Zoom/⏮/Q button returns the screen to full screen display of the selected image.

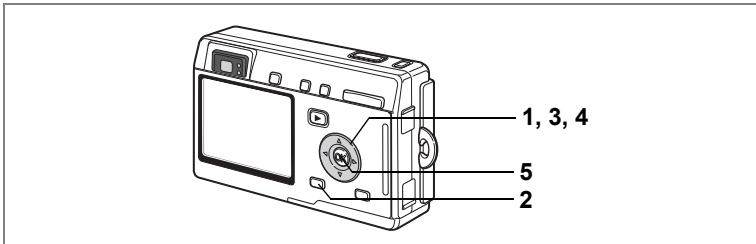

## Slideshow

You can play back all the images on the SD Memory Card or in the built-in memory continuously.

**1 Enter the Playback mode and use the four-way controller (◀▶) to choose the image with which to start the slideshow.**

**2 Press the MENU button.**

The [▶ Playback] menu appears.

**3 Use the four-way controller (▼) to select [Slideshow].**



**4 Use the four-way controller (◀▶) to change the playback interval.**

Choose from the following: [3 sec], [5 sec], [10 sec], [15 sec], [20 sec], [25 sec], [30 sec].

**5 Press the OK button.**

[Slideshow start] appears on the LCD monitor and playback starts at the set interval.

Press any button, such as the OK button or MENU button, to stop the slideshow. [Slideshow stop] appears on the LCD monitor.



- The slideshow will continue until you press any button.
- Moving pictures and pictures with a voice memo will be played through to the end before the next picture is played back, regardless of the set playback interval.
- Recordings made in Voice Recording mode are not played back.



# Deleting Images, Moving Pictures and Sound

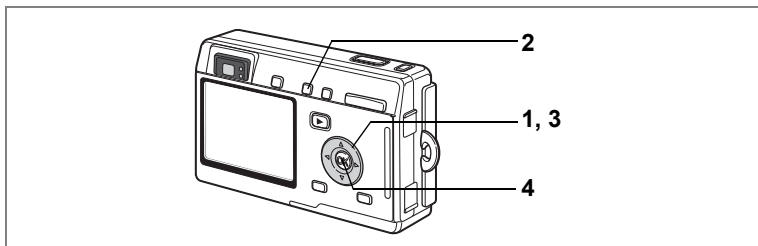

## Deleting a Single Image or Sound

You can delete single images or sounds.



- Once deleted, images cannot be restored.
- You cannot delete protected images. (p.98)

**1** Enter the **Playback mode** and use the **four-way controller (◀▶)** to choose the image or sounds to delete.

**2** Press the **🗑️ button**.

The Delete screen appears.

**3** Use the **four-way controller (▲)** to select **[Delete]**.

**4** Press the **OK button**.

The image or sound is deleted.



- You can also delete images from Instant Review (p.79).
- You cannot delete protected images (with the **🔒** icon).
- If [Quick Delete] is set to On in the [▶ Playback] menu, Step 3 can be omitted. (p.96)

## Deleting a Voice Memo only

If an image has a voice memo, you can delete the voice memo without deleting the image.

- 1 Enter the Playback mode and use the four-way controller (◀▶) to choose an image with a voice memo to delete.**
- 2 Press the  button.**  
The Delete screen appears.
- 3 Use the four-way controller (▲) to select [Sound Delete].**
- 4 Press the OK button.**  
The voice memo is deleted.



Select [Delete] in Step 3 above to delete both the image and the voice memo.

## 6

## Setting the Quick Delete Function

When the Quick Delete function is set to [On], the Delete screen appears with [Delete] or [Delete All] already selected.

- 1 Select [Quick Delete] on the [ Playback] menu.**
- 2 Use the four-way controller (◀▶) to select [On] or [Off].**
- 3 Press the OK button.**  
The camera is ready to take or play back images.

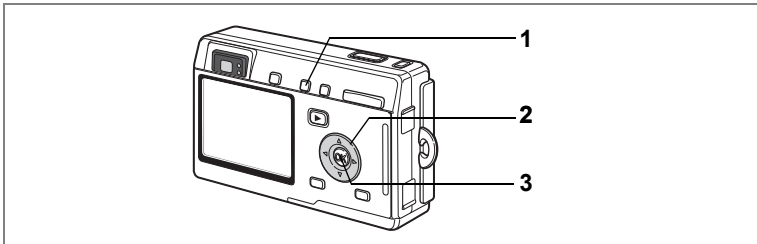



## Deleting All Images

You can delete all the images and sounds at once.



- Once deleted, images cannot be restored.
- Protected images and sounds cannot be deleted.

- 1 Enter the Playback mode and press the  button twice.**  
The Delete All screen appears.
- 2 Use the four-way controller () to select [Delete All].**
- 3 Press the OK button.**  
All the images and sounds will be deleted.



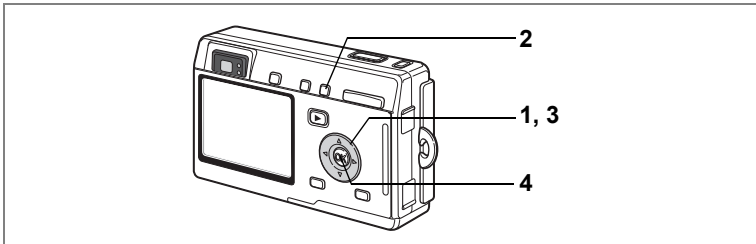

## Protecting Images and Sounds from Deletion (Protect)

You can protect images and sounds from being accidentally deleted.

- 1 Enter the Playback mode and use the four-way controller (◀▶) to choose the image or sound to protect.**
- 2 Press the  button.**  
The Protect screen appears.
- 3 Use the four-way controller (▲) to select [Protect].**
- 4 Press the OK button.**



- Select [Unprotect] in Step 3 to cancel the Protect setting.
- If the image is protected, the  icon appears when the image or sound is played back.

## Protecting All Image and Sounds

You can protect all the images and sounds.

- 1 Enter the Playback mode.**
- 2 Press the  button twice.**  
The Protect All screen appears.
- 3 Use the four-way controller (▲) to select [Protect].**
- 4 Press the OK button.**



- Select [Unprotect] in Step 3 to cancel the Protect setting on all the images and sounds.



- Even protected images and sounds will be deleted by formatting the SD Memory Card or built-in memory.

# Viewing Images on a TV

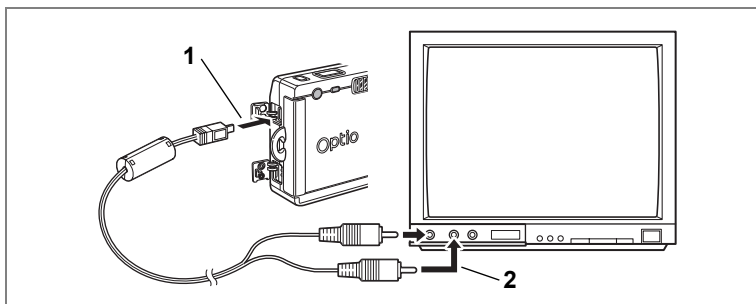

By using the AV cable, you can capture and play back images on a TV or other equipment with a video IN jack. Make sure that both the TV and the camera are turned off before connecting the cable.

- 1 Open the terminal cover and connect the AV cable.**
- 2 Connect the other end of the AV cable to the image input terminal and sound input terminal on the TV.**

When using stereo sound equipment, insert the sound terminal into the L (white) terminal.

- 3 Turn the TV and camera on.**

Changing the Video Output Format esp.p.119



If you intend to use the camera for a long time, use of the AC adapter kit D-AC8 (optional) is recommended. Refer to the operating manual for the TV or equipment to which the camera is connected.

# Setting the Printing Service (DPOF)

You can print the images on the SD Memory Card using a DPOF (Digital Print Order Format) compatible printer or at a printing service.

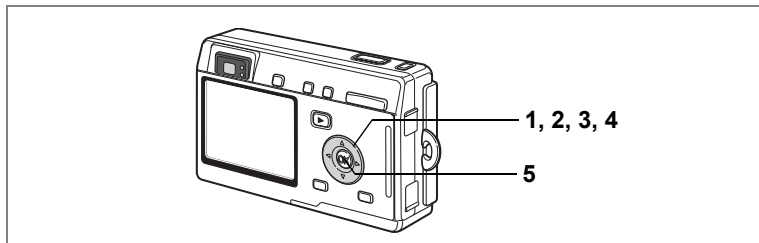

## Printing Single Images

Set the following items for each image.

Copies: Choose the number of copies up to a maximum of 99.

Date: Specify whether you want the date imprinted on the print or not.

6

Playback/Deleting/Editing

- 1 Enter the Playback mode and use the four-way controller (◀▶) to choose the image to print.**
- 2 Press the four-way controller (▲).**  
The DPOF screen appears.



- 3 Use the four-way controller (◀▶) to choose the number of copies, then press the four-way controller (▼).**

The frame moves to [Date].



- 4 Use the four-way controller (◀▶) to choose whether to insert the date or not.**

- (On) : The date will be imprinted.
- (Off) : The date will not be imprinted.

- 5 Press the OK button.**

Prints can be made according to the settings.



- If DPOF settings have already been made for an image, the previous number of copies and date setting will be displayed.
- To cancel DPOF settings, set the number of copies to 0 and press the OK button.



- You cannot set the printing service for moving pictures or sound-only files.
- Depending on the printer or printing equipment at the photo processing lab., the date may not be imprinted on the pictures even if the DPOF settings were made.

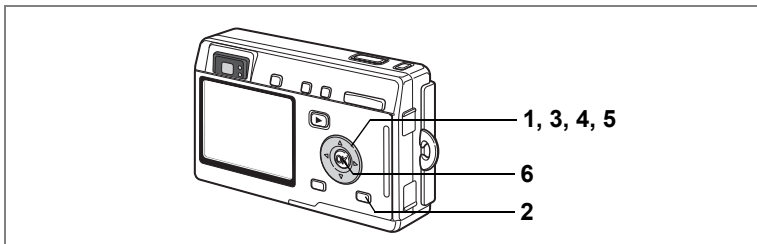

## Printing All Images

- 1** Enter the Playback mode and press the four-way controller (▲).
- 2** Press the DISPLAY button.
- 3** Use the four-way controller (◀▶) to choose the number of copies.  
You can print up to 99 copies.
- 4** Press the four-way controller (▼).  
The frame moves to [Date].
- 5** Use the four-way controller (◀▶) to choose whether to insert the date or not.  
 (On) : The date will be imprinted.  
 (Off) : The date will not be imprinted.
- 6** Press the OK button.  
Prints can be made according to the settings.



The number of copies specified in the DPOF settings applies to all the images. Before printing, check that the number is correct.



- Settings for single images are cancelled when settings are made for all images.
- DPOF settings are not possible for moving pictures.



# Direct Printing Using PictBridge

By connecting the camera to a printer that supports PictBridge using the USB cable (I-USB7) supplied with the camera, you can print images directly from the camera without using a PC. Select the images you want to print and the number of copies on the camera after it has been connected to the printer.



- You are recommended to use the AC adapter kit D-AC8 (optional) while the camera is connected to the printer. The printer may not work properly or the image data may be damaged if the battery runs out of power while the camera is connected to the printer.
- The focus status lamp and flash status lamp blink slowly while data is being transferred from the camera to the printer.
- Do not disconnect the USB cable during data transfer.
- Depending on the type of printer, not all the settings made on the camera (such as image quality and DPOF settings) may be valid.

## Connecting the Camera to the Printer

**1** Select [PictBridge] for [USB Connection Mode] on the [Set-up] menu.

See “Changing the USB Connection Mode” (p.119)

**2** Connect the camera to the printer using the USB cable supplied with the camera.

The PictBridge menu appears.

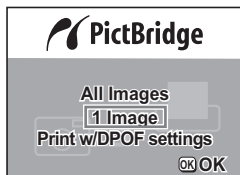

## Printing Single Images

- 1 Use the four-way controller (▲▼) to select [1 Image].**

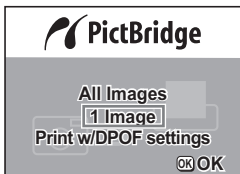

- 2 Press the OK button.**

The Print This Image screen appears.

- 3 Use the four-way controller (◀▶) to choose the image to print.**

- 4 Use the four-way controller (▲▼) to choose the number of copies.**

You can print up to ten copies.



- 5 Use the DISPLAY button to choose whether to insert the date or not.**

- (On) : The date will be imprinted.
- (Off) : The date will not be imprinted.

- 6 Press the OK button.**

Prints can be made according to the settings.

Press the OK button to return to Step 3 and continue printing. Press the MENU button to exit printing.

Press the MENU button to stop printing halfway.

## Printing All Images

**1 Use the four-way controller (▲▼) to select [All Images].**

**2 Press the OK button.**

The Print All screen appears.

Use the four-way controller (◀▶) to check the images and make sure you want to print them all.

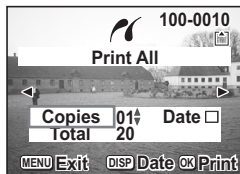

**3 Use the four-way controller (▲▼) to choose the number of copies.**

The number of copies you choose applies to all the images.

**4 Use the DISPLAY button to choose whether to insert the date or not.**

(On) : The date will be imprinted.

(Off) : The date will not be imprinted.

**5 Press the OK button.**

All the images will be printed according to the settings.

## Printing Using the DPOF Settings

**1 Use the four-way controller (▲▼) to select [Print w/DPOF settings].**

**2 Press the OK button.**

The Print w/DPOF Settings screen appears.

Use the four-way controller (◀▶) to check the images and the print settings.

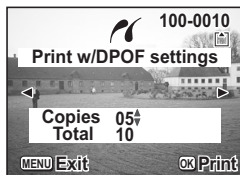

**3 Press the OK button.**

The selected image is printed according to the DPOF settings.

## Disconnecting the Camera from the Printer

Disconnect the camera from the printer when you have finished printing.

- 1 Turn the camera off.**
- 2 Disconnect the USB cable from the camera.**
- 3 Disconnect the USB cable from the printer.**



If you press the MENU button while the “Continue printing?” message is displayed, the message “Safely remove USB cable” is displayed.

When you disconnect the USB cable from the camera, the camera automatically switches to Capture mode.

# Editing Images

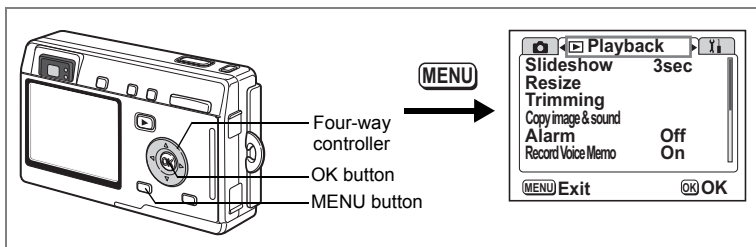

## Changing the Image Size and Quality

By changing the size and quality of a selected image, you can make the file smaller than the original. You can use this function to continue taking pictures when the card or memory is full, by making the images smaller and overwriting the original images to make more space available in the memory.

### Resizing Single Images

After changing the size and quality, the image can be saved as a new image or written over the original image.

- 1 Press the MENU button in Playback mode.**  
The [▶ Playback] menu appears.
- 2 Use the four-way controller (▲▼) to select [Resize].**
- 3 Press the four-way controller (▶).**  
The Resize screen appears.
- 4 Use the four-way controller (◀▶) to choose the image to resize.**
- 5 Press the OK button.**  
The size and quality options screen appears.



**6** Use the four-way controller (◀▶) to change the size.

**7** Press the four-way controller (▼).  
The frame moves to [Quality Level].

**8** Use the four-way controller (◀▶) to change the quality.

**9** Press the OK button.

**10** Use the four-way controller (▲▼) to select [Overwrite] or [Save as].

**11** Press the OK button.

The resized image is saved.

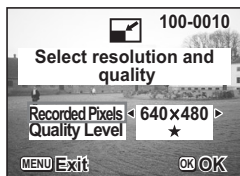

- Moving pictures cannot be resized.
- You cannot select a larger size than that of the original image.
- You cannot select a higher quality than that of the original image.

## Resizing All Images

You can change the size of all the images saved on the SD Memory Card or in the built-in memory.

**4** Press the DISPLAY button in Step 3 on the previous page.

The Resize All screen appears.

**5** Use the four-way controller (◀▶) to change the size.

**6** Press the four-way controller (▼).

The frame moves to [Quality Level].

**7** Use the four-way controller (◀▶) to change the quality.

**8** Press the OK button.

**9** Use the four-way controller (▲▼) to select [Overwrite] or [Save as].

**10** Press the OK button.

All the images that are bigger than the selected size are resized and saved.



- Moving pictures cannot be resized.
- Images that are smaller than the selected size are not resized.
- Protected images (with the  icon) cannot be overwritten.

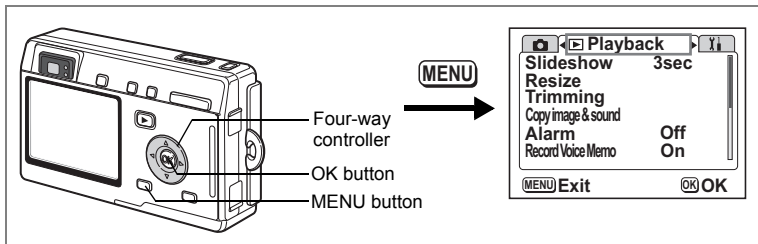

## Trimming Images

You can trim part of a picture and save it as a separate image.

- 1 Press the MENU button in Playback mode.**  
The [▶ Playback] menu appears.
- 2 Use the four-way controller (▲▼) to select [Trimming].**
- 3 Press the four-way controller (▶).**  
The images that can be trimmed are displayed.
- 4 Use the four-way controller (◀▶) to choose an image to trim.**
- 5 Press the OK button.**  
The Trimming screen appears.



- 6 Trim the image.**
  - **Operations that can be performed on the Trimming screen**  
Zoom/☒/Q button: Changes the size of the trimming  
Four-way controller (▲▼◀▶):  
Moves the trimming position up, down, left and right  
MENU button: Returns to the screen for selecting an image
- 7 Press the OK button.**  
The trimmed image is saved as a separate image.



- Moving pictures cannot be trimmed.
- The image size is changed and saved.

# Copying Files

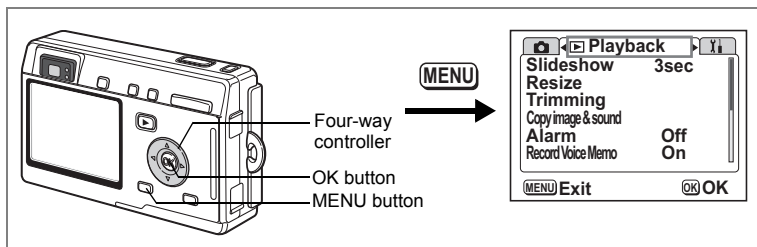

You can copy image and sound files from the built-in memory to the SD Memory Card and vice versa. This function can only be selected when a card has been inserted in the camera.

When files are copied from the built-in memory to the SD Memory Card, all the files are copied at once. When files are copied from the SD Memory Card to the built-in memory, the files are copied one at a time.

## 1 Press the MENU button in Playback mode.

The [▶ Playback] menu appears.

## 2 Use the four-way controller (▼) to select [Copy Image & Sound].

## 3 Press the four-way controller (▶).

The Copy Image & Sound screen appears. Choose the copying method you want to use.



Be sure to turn the camera off before inserting or removing the SD Memory Card.

## To Copy Files from the Built-in Memory to the SD Memory Card

## 4 Use the four-way controller (▲▼) to select [📷 → SD] and press the OK button.

All the files are copied to the SD Memory Card.

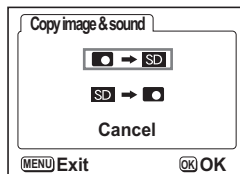



## To Copy Files from the SD Memory Card to the Built-in Memory

- 5 Use the four-way controller (▲▼) to select [SD → ] and press the OK button.
- 6 Use the four-way controller (◀▶) to select the file to copy.
- 7 Press the OK button.

The selected file is copied to the built-in memory.



- If the image has a voice memo attached, the sound file will be copied at the same time as the image.
- When a file is copied from the SD Memory Card to the built-in memory, it is assigned a new file name.

How to recall the [Yi Set-up] menu

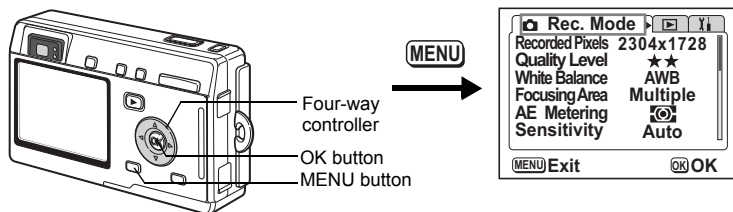

## Formatting an SD Memory Card or the Built-in Memory

Formatting will delete all the data on the SD Memory Card if you are using a card, and all the data in the built-in memory if there is no SD Memory Card inserted.



- Do not remove the SD Memory Card while the card is being formatted as this may damage the card and render it unusable.
- SD Memory Cards formatted on a PC or device other than the camera cannot be used. Be sure to format the card with the camera.
- Formatting will delete protected data too.

7

Settings

**1 Select [Format] on the [Yi Set-up] menu.**

**2 Press the four-way controller (▶).**

The Format screen appears.

**3 Use the four-way controller (▲) to select [Format].**

**4 Press the OK button.**

Formatting starts. When formatting is completed, the camera is ready to take pictures.

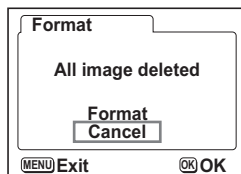

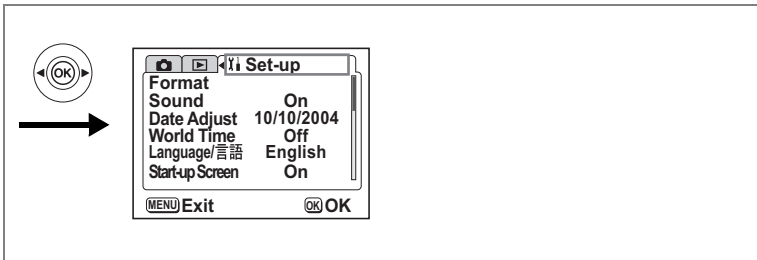

## Changing the Start-up Screen

You can display an image recorded with the camera as the start-up screen when the camera is turned on.

- 1** Select [Start-up Screen] on the [*xi* Set-up] menu.
- 2** Press the four-way controller (▶).  
The Change Start-up screen appears.
- 3** Press the DISPLAY button.
- 4** Use the four-way controller (◀▶) to choose an image for the start-up screen.
- 5** Press the OK button.
- 6** Use the four-way controller (◀▶) to choose whether to display the start-up screen or not.  
 (On) : Displays the start-up screen  
 (Off) : Hides the start-up screen
- 7** Press the OK button twice.  
The camera is ready to take or play back images.

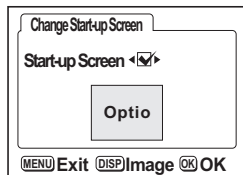

- Once the start-up screen has been set, it will not be deleted even if the original image is deleted or the SD Memory Card or built-in memory is formatted. To delete the start-up screen, reset the settings. (p. 123)
- If the camera is turned off in the Green mode, the Green mode start-up screen will appear next time the camera is turned on. The Green mode start-up screen cannot be changed.

## How to recall the [i Set-up] menu

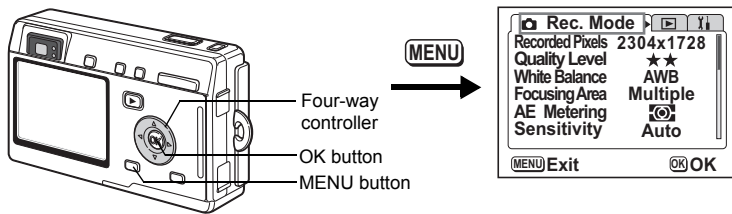

## Changing the Sound Settings

You can adjust the playback volume and the volume of operation sounds, such as the start-up sound, shutter sound and key operation sound. You can also change the operation sounds.

- 1 Select [Sound] on the [i Set-up] menu.**
- 2 Press the four-way controller (▶).**  
The Sound screen appears.

### Changing the Volume

- 3 Use the four-way controller (◀▶) to change the playback volume.**
- 4 Use the four-way controller (▼) to select [Operation Volume].**
- 5 Use the four-way controller (◀▶) to change the volume of operation sounds.**
- 6 Press the OK button twice.**  
The camera is ready to take or play back images.

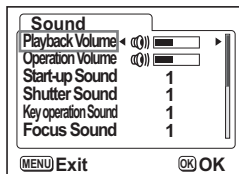

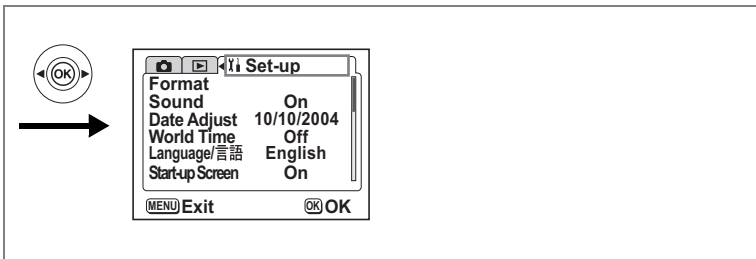

## Changing the Start-up Sound, Shutter Sound, Key Operation Sound, Focus Sound and Self-timer Sound

- 7** Use the four-way controller (▼) to select [Start-up Sound].
- 8** Use the four-way controller (◀▶) to select [1], [2], [3] or [Off].
- 9** Change the [Shutter Sound], [Key Operation Sound], [Focus Sound] and [Self-timer Sound] in the same way.
- 10** Press the OK button twice.

The camera is ready to take or play back images.



The Sound settings are saved when the camera is turned off.

7

Settings

## Changing the Date and Time

You can change the initial date and time settings. You can also set the style in which the date appears on the camera. Choose [mm/dd/yy], [dd/mm/yy] or [yy/mm/dd].

- 1** Select [Date Adjust] on the [Xi Set-up] menu.
- 2** Press the four-way controller (▶).

The Date Adjust screen appears.

Refer to “Initial Settings” (p.23) for the setting procedure.

## How to recall the [i Set-up] menu

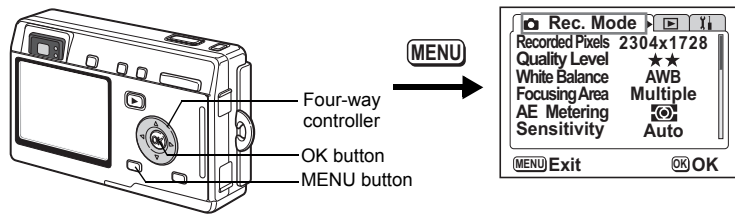

## Setting the World Time

The date and time selected in “Initial Settings” (p.23) serve as the Home Time setting.

You can display the time in a city other than the Home Time city (World Time). This is useful when taking pictures abroad.

**1 Select [World Time] on the [i Set-up] menu.**

**2 Press the four-way controller (▶).**

The World Time screen appears.

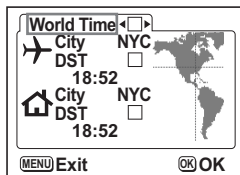

**3 Use the four-way controller (◀▶) to switch between [✓] and [□].**

✓ : The time in the city selected in World Time is displayed.

□ : The time in the city selected in Home Time is displayed.

**4 Press the four-way controller (▼).**

If New York is selected as the World Time city, the location of New York is marked on the world map and ➔ indicates the current time in New York (NYC).

**5 Use the four-way controller (◀▶) to choose ➔ (the World Time) city and press the four-way controller (▼).**

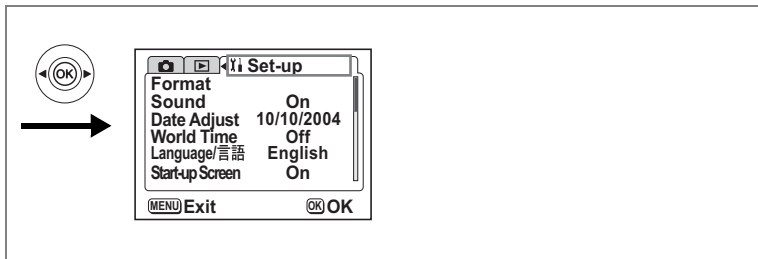

**6 Use the four-way controller (◀▶) to turn [DST] on (☑) or off (☐) and press the four-way controller (▼).**

The frame moves to [🏠] (Home Time city).

The default setting of the [🏠] (Home Time city) is [NYC (New York)].

Use the four-way controller (◀▶) to change the [🏠] Home Time city and choose the DST setting.

**7 Press the OK button twice.**

The camera is ready to take or play back images with the time in the selected city.



Refer to page 126 for the list of cities and code names.

## How to recall the [Yi Set-up] menu

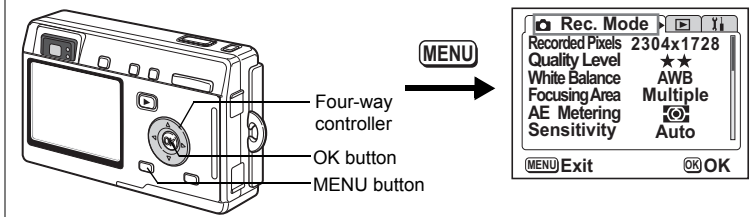

## Changing the Display Language

You can change the language in which the menus, error messages, etc. are displayed.

You can choose from English, French, German, Spanish, Italian, Russian, Korean, Chinese [traditional and simplified], Korean and Japanese.

- 1 Select [Language/言語] on the [Yi Set-up] menu.**
- 2 Use the four-way controller (◀▶) to choose the language.**
- 3 Press the OK button.**

The camera is ready to take or play back images.



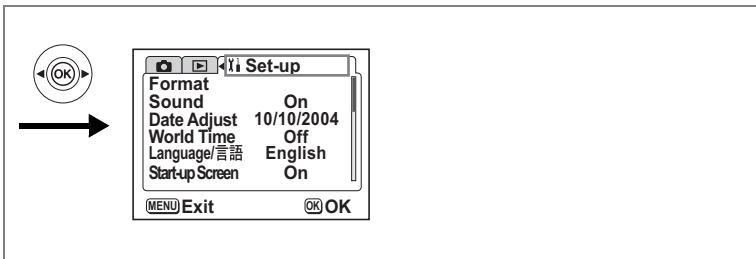

## Changing the Video Output Format

You can select the output format (NTSC or PAL) for taking or playing back images on a TV.

- 1 Select [Video Out] on the [Set-up] menu.**
- 2 Use the four-way controller (◀▶) to select [NTSC] or [PAL].**  
Choose the video output format to match the output format of the TV.
- 3 Press the OK button.**  
The camera is ready to take or play back images.

## Changing the USB Connection Mode

You can change the USB connection mode depending on whether the USB cable is to be connected to a printer (PictBridge) or a computer.

- 1 Select [USB Connection Mode] on the [Set-up] menu.**
- 2 Use the four-way controller (◀▶) to select [PC] or [PictBridge].**
- 3 Press the OK button.**  
The camera is ready to be connected to the computer or printer.

## How to recall the [Yi Set-up] menu

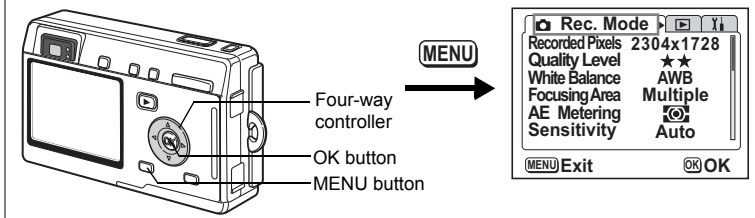

## Sleep Timeout

You can set the LCD monitor to turn off automatically when no operation is performed for a fixed time.

- 1 Select [Sleep Timeout] on the [Yi Set-up] menu.**
- 2 Use the four-way controller (◀▶) to select [30 sec], [1 min], [2 min] or [Off].**
- 3 Press the OK button.**

The camera is ready to take or play back images.



This function will not work when playing the slideshow or when the USB cable is connected.

7

Settings

## Setting Auto Power Off

You can set the camera to turn off automatically when no operation is performed for a fixed time.

- 1 Select [Auto Power Off] on the [Yi Set-up] menu.**
- 2 Use the four-way controller (◀▶) to select [3 min], [5 min] or [Off].**
- 3 Press the OK button.**

The camera is ready to take or play back images.



The Auto Power Off function will not work when the USB cable is connected.

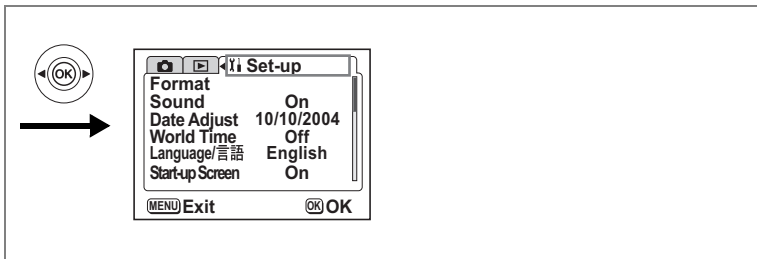

## Registering a Function (Custom Function)

You can register the function you use most frequently on the four-way controller (◀▶). The function can then be called directly by pressing the four-way controller (◀▶), without displaying the [Rec.Mode] menu. The default setting is [EV Compensation].

### Registering a Function

- 1 Select [Custom Function] on the [i Set-up] menu.**
- 2 Use the four-way controller (◀▶) to choose the function to register.**
- 3 Press the OK button.**

The selected function is registered.

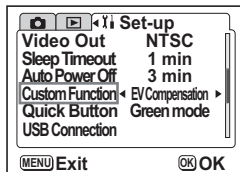

Only one function can be registered on the four-way controller key (◀▶). You can choose from the following 12 functions: EV Compensation, Recorded Pixels, Quality Level, White Balance, Focusing Area, AE Metering, Sensitivity, Time-Lapse Movie, Instant Review, Sharpness, Saturation and Contrast.

### Retrieving a Function

- 1 Press the four-way controller (◀▶) in Capture mode.**

The function set by Custom Function is recalled.

The default setting is [EV Compensation].



EV Compensation

## How to recall the [i Set-up] menu

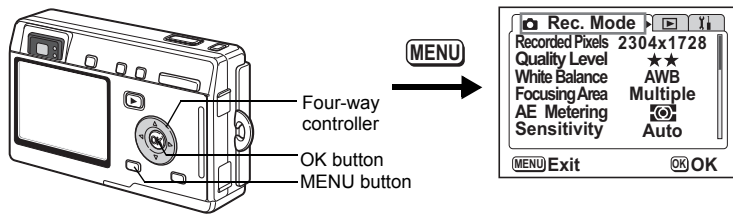

## Setting the QUICK Button

You can register a function on the QUICK button. The function can then be activated simply by pressing the QUICK button in either Capture mode or Playback mode. The default setting is Green mode (■) for easy picture-taking.

### Registering a Function

- 1 Select [Quick Button] on the [i Set-up] menu.
- 2 Use the four-way controller (▲▼◀▶) to choose the function to register.
- 3 Press the OK button.

The selected function is registered.

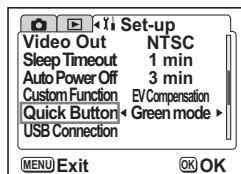

Only one function can be registered on the QUICK button. You can choose from the following 12 functions: Green Mode, Capture Mode, White Balance, Memory, Resize, Trimming, Copy Image & Sound, Alarm, Format, Sound, World Time and Start-up Screen.



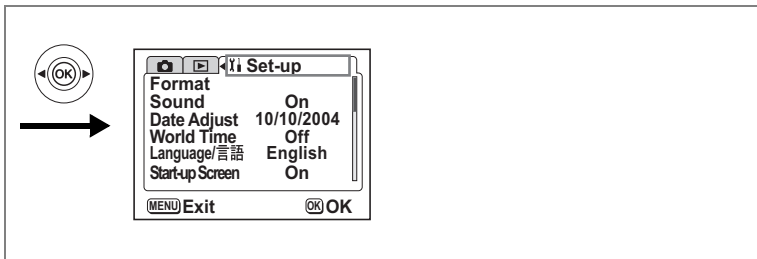

## Resetting to Default Settings

You can return all the settings other than the date and time, language/言語, world time and alarm to the default settings.

- 1 Select [Reset] on the [i Set-up] menu.**
- 2 Press the four-way controller (▶).**  
The Reset screen appears.
- 3 Use the four-way controller (▲) to select [Reset].**
- 4 Press the OK button.**

The settings return to the defaults and the camera is ready to take or play back images.

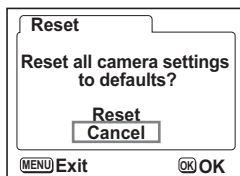

# Setting the Alarm

You can set the alarm to ring at a specified time and display a selected image.

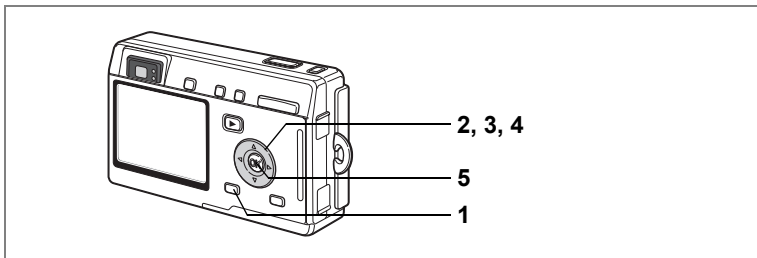

## Checking the Alarm

- 1 Press the MENU button.**
- 2 Press the four-way controller (▶).**  
The [▶ Playback] menu appears.
- 3 Press the four-way controller (▲▼) to select [Alarm].**
- 4 Press the four-way controller (▶).**  
The list of alarms appears.  
Active alarms are indicated by .
- 5 Press the OK button twice.**  
If any alarms are enabled, the camera will be turned off and the alarms will be set.

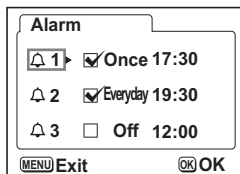

## Setting the Alarm

- 1 Press the MENU button.**
- 2 Press the four-way controller (▶).**  
The [▶ Playback] menu appears.
- 3 Press the four-way controller (▲▼) to select [Alarm].**

#### 4 Press the four-way controller (▶).

The list of alarms appears.

#### 5 Press the four-way controller (▲▼) to choose Alarm [1], [2] or [3].

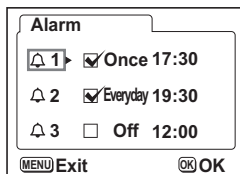

#### 6 Press the four-way controller (▶).

The screen for setting the alarm mode and time appears.

Four-way controller (◀▶): Selects the item.

Four-way controller (▲▼): Changes the setting.

#### 7 Press the DISPLAY button.



#### 8 Use the four-way controller (◀▶) to choose the image to be displayed when the alarm rings.

#### 9 Press the OK button.

The screen returns to the list of alarms.

#### 10 Press the OK button three times.

The camera turns off.

## Turning the Alarm Off

The alarm rings for one minute and the selected image is displayed when the set time is reached with the camera turned off.

The camera turns off automatically when the alarm has finished ringing.



To turn the alarm off, press any button.



The alarm will not ring when the camera is turned on.

## List of City Codes

Refer to the following list of city codes when setting the World Time.

TYO	Tokyo	JNB	Johannesburg
GUM	Guam	IST	Istanbul
SYD	Sydney	CAI	Cairo
NOU	Noumea	JRS	Jerusalem
WLG	Wellington	MOW	Moscow
AKL	Auckland	JED	Jeddah
PPG	Pagopago	THR	Tehran
HNL	Honolulu	DXB	Dubai
ANC	Anchorage	KHI	Karachi
YVR	Vancouver	KBL	Kabul
SFO	San Francisco	MLE	Male
LAX	Los Angeles	DEL	Delhi
YYC	Calgary	CMB	Colombo
DEN	Denver	KTM	Kathmandu
MEX	Mexico City	DAC	Dacca
CHI	Chicago	RGN	Rangoon
MIA	Miami	BKK	Bangkok
YTO	Toronto	KUL	Kuala Lumpur
NYC	New York	VTE	Vientiane
SCL	Santiago	SIN	Singapore
CCS	Caracas	PNH	Phnom Penh
YHZ	Halifax	SGN	Ho Chi Minh
BUE	Buenos Aires	JKT	Jakarta
SAO	Sao Paulo	HKG	Hong Kong
RIO	Rio de Janeiro	PER	Perth
MAD	Madrid	BJS	Beijing
LON	London	SHA	Shanghai
PAR	Paris	MNL	Manila
MIL	Milan	TPE	Taipei
ROM	Rome	SEL	Seoul
BER	Berlin	ADL	Adelaide



## Optional Accessories

A number of dedicated accessories are available for this camera.

**AC adapter D-AC8**

**USB cable I-USB7 (\*)**

**AV cable I-AVC7 (\*)**

**Camera case O-CC8**

**Strap O-ST20 (\*)**

**Remote control unit F**

**Rechargeable lithium-ion battery D-LI8 (\*)**

**Battery charger D-BC20 (\*)**

**Battery charger D-BC8**

**Waterproof case O-WP2**

**3D image viewer O-3DV1**

Products marked with an asterisk (\*) are the same as those supplied with the camera.

# Messages

Messages such as the following may appear on the LCD monitor during camera operation.









Compression error	Compression of the image you captured has failed. Change the quality/size and try again.
Alarm was set	The alarm is enabled and the camera turns off automatically.
No image & sound	There are no images/sound on the SD Memory Card or in the built-in memory.
Memory card full Built-in memory full	The SD Memory Card or the built-in memory is full and no more images can be saved. Insert a new SD Memory Card or delete unwanted images. (p.20, 95) Change the quality size and try again. (p.107, 109)
Memory card error	Shooting and playback are impossible due to a problem with the SD Memory Card. Try displaying on a PC.
Card not formatted	The SD Memory Card you have inserted is unformatted or has been formatted on a PC or other device and is not compatible with this camera. (p.112)
Card locked	The SD Memory Card is write-protected. Only menu operation and mode change are possible.
Data being recorded	The image is being recorded on the SD Memory Card or in the built-in memory. The protect setting or DPOF settings is being changed.
Data being recorded	The moving picture is being recorded.
Camera cannot play back this image or sound	You are trying to play back an image or sound in a format not supported by this camera. You may be able to play it back on another brand of camera or PC.
Deleting	The image is being deleted.
Battery depleted Cannot save image	The battery is exhausted. Recharge the battery or replace with charged battery. (p.14)
Formatting...	The SD Memory Card or built-in memory is being formatted.
Image folder could not be created	The largest file number has been assigned to an image and no more images can be saved. Insert a new SD Memory Card or format the SD Memory Card or built-in memory. (p.112)
Image protected	The image you are trying to delete is a protected image.

Messages such as the following may appear on the LCD monitor when using the PictBridge function.

No paper	There is no paper in the printer.
No ink	There is no ink in the printer.
Printer error	An error message has been sent from the printer.
Data error	A data error message has been sent from the printer.
Jammed	The paper in the printer has jammed.

# Troubleshooting

Problem	Cause	Remedy
Camera will not turn on	Battery is not installed	Check battery is installed. If not, install battery.
	Battery is installed incorrectly	Check orientation of battery. Reinsert battery with (◀) symbol towards back of camera. (p.14)
	Battery power is low	Insert a charged battery or use the AC adapter kit.
No image on the LCD monitor	LCD monitor is set to OFF	Press DISPLAY button to turn LCD monitor on. (p.68)
	Image is displayed but is hard to see	Image on LCD monitor may be hard to see when taking pictures outside in sunlight.
Shutter will not release	Flash is charging	When flash status lamp blinks red, flash is charging and no pictures can be taken. Lamp lights red when charging is completed.
	No available space on SD Memory Card or in built-in memory	Insert SD Memory Card with available space or delete unwanted images. (p.20, 95)
	Recording	Wait until recording is finished.
Picture is dark	Subject is too far away in a dark environment, such as a night scene	Picture becomes dark if subject is too far away. Take picture within range of flash.
	Background is dark	When taking a picture of a person against a dark background, such as a night scene, the person may appear dark if the flash does not reach the background even with the correct exposure. Set to  mode to ensure both person and background are clear. (p.66)

Problem	Cause	Remedy
Subject is not in focus	Subject difficult to focus on	Subjects difficult to focus on using autofocus: objects with little contrast (blue sky, white walls, etc.), dark objects, finely patterned objects, fast-moving objects, scenery through window or net, etc. Lock focus on another object located at same distance (press shutter release button halfway), then aim at target and press shutter release button fully, or use Manual Focus mode.
	Subject is not in focusing area	Position subject in focus frame (focusing area) in middle of LCD monitor. If the subject is outside the focusing area, aim the camera at the subject and lock the focus (press shutter release button halfway), then compose picture and press the shutter release button fully.
	Subject is too close	Set focus mode on  (Macro) or  (Super Macro). (p.69)
	Focus mode is set on  (Macro) or  (Super Macro)	Normal pictures will be out of focus if taken with focus mode set on  (Macro) or  (Super Macro).
Flash does not discharge	Flash mode is set to Off	Set to Auto or  . (p.71)
	The Capture mode is set to  , Continuous Shooting, Super Macro, Infinity-Landscape or  (Marine Moving Picture) mode	Flash will not discharge in these modes.

# Main Specifications

## Camera

Type	Fully automatic compact digital still camera with built-in zoom lens		
Effective Pixels	4.0 megapixels		
Sensor	4.23 megapixels (total pixels), 1/2.5-inch interline transfer CCD with a primary color filter		
Recorded Pixels	Still Picture	2304×1728 pixels, 1600×1200 pixels 1024×768 pixels, 640×480 pixels	
	Moving Picture	320×240 pixels	
Sensitivity	Auto, manual (equivalent to ISO 50, 100, 200, 400)		
File Format	Still Picture	JPEG (Exif2.2), DCF, DPOF, PRINT Image Matching II	
	Moving Picture	AVI (Open DML Motion JPEG), approx. 15 fps, with sound	
	Sound	WAV (ADPCM system), max. recording time 59 min. 46 sec. (when using a 16 MB SD Memory Card)	
Quality Level	"Best", "Better", "Good"		
Storage Medium	Built-in memory (approx. 10 MB), SD Memory Card		

### Image Storage Capacity (When using a 16MB SD Memory Card)

Recorded Pixels \ Quality Level	Best	Better	Good	Moving Picture (320×240)
	2304×1728	3	6	
1600×1200	8	14	20	
1024×768	18	33	43	
640×480	40	62	83	

White Balance	Auto, Daylight, Shade, Tungsten Light, Fluorescent Light, Manual			
Lens	Focal Length	5.8 mm – 17.4 mm (equivalent to 35 mm - 105 mm in 35 mm format)		
	Maximum Aperture	f/2.6 – f/4.8		
	Lens Composition	6 elements in 5 groups (two aspherical elements)		
	Zoom Type	Electrically driven		
	Picture Range	39.5 mm × 29.6 mm (screen is filled) (Super Macro mode)		
	Lens Barrier	Electrically driven		
Digital Zoom	Capture/Playback Mode	Max 4× (combines with 3× optical zoom to give zoom magnification equivalent to 12×)		
Viewfinder	Type	Real-image zoom viewfinder		
	Magnification	Wide 0.28×, Tele 0.78×		
LCD Monitor	1.8-inch TFT color LCD with 85 kilopixels monitor (with backlight), viewfinder frame coverage approx. 100%			
Playback Functions	Single-frame, 9-frame index, enlargement (max. 4×), scroll, rotating, slideshow, movie playback, histogram display, image/sound copying, trimming, resizing, alarm			

Focusing System	Type	TTL contrast detection system by sensor 7-point autofocus (spot autofocus possible)
	Focusing Range (from lens front)	Normal: 0.4 m – ∞ (full zoom range) Macro: 0.18 m – 0.5 m (full zoom range) Super Macro: 0.06 m – 0.2 m (middle zoom position only) Landscape: ∞ (full zoom range)
	Focus Lock	By half-pressing shutter release button
Manual Focus	0.18 m - ∞ (0.06 m - ∞ around the focal length midpoint)	
Exposure Mechanism	AE Metering	TTL metering by sensor (multi-segment, center-weighted, spot)
	Capture Modes	Green, Program, Picture (Landscape, Flower, Portrait, Self-Portrait, Surf & Snow, Autumn Colors, Sunset, Museum, Text, Food), Soft Focus, Posterization, Night Scene, Moving Picture, Panorama Assist, 3D, Digital Filter, USER, Marine, Marine Moving Picture
	EV Compensation	±2 EV (can be set in 1/3 EV steps)
	Moving Picture	Recording time approx. 1 sec. until memory card is full
Shutter	Type	Electronic/mechanical shutter
	Speed	Approx. 1/2000 sec. – 4 sec.
Flash	Type	Auto flash with red-eye reduction function
	Flash Modes	Auto, Flash Off, Flash On, Auto + Red-eye Reduction, Flash On + Red-eye Reduction
	Working Range	Wide: approx. 0.2 m – 3.5 m (5.8 mm w/sensitivity at 200) Tele: approx. 0.2 m – 2.0 m (17.4 mm w/sensitivity at 200)
Drive Modes	Single-frame, Continuous, 3-sec. Remote Control, Instant Remote Control, 10-sec. Self-timer, 2-sec. Self-timer	
Self-Timer	Electronic control type, delay time: approx. 10 sec., 2 sec.	
Time Function	World Time setting for 62 cities (28 time zones)	
Alarm	Alarm with simultaneous display of selected image at specified time (max. 3 alarms)	
Power Supply	Rechargeable lithium-ion battery D-Li8, AC adapter kit (optional)	
Battery Life	Approx. 180 images	(at 25°C with LCD monitor on, flash fired for 50% of shots and using a rechargeable lithium ion battery D-Li8, in accordance with PENTAX measuring conditions)
In/Out Port	USB/AV terminal (PC communication type USB 1.1), external power supply terminal	
Video Output Format	NTSC, PAL	
Size	84 (W) × 52 (H) × 20.5 (D) mm (excluding operating members and projections)	
Weight	105 g (excluding battery and SD Memory Card)	
Weight When Shooting	120 g (including battery and SD Memory Card)	
Accessories	Rechargeable lithium-ion battery, battery charger, AC plug cord, USB cable, software (CD-ROM), AV cable, strap, operating manual	

## Power Supply

	Battery Charger D-BC20	AC Adapter D-AC8 (optional)
Rated input	AC100-200V (50Hz/60Hz)	AC100-200V (50Hz/60Hz)
Rated output	DC 4.2 V / 0.63 A	DC 4.5 V/2 A
External dimensions	93 × 65 × 27.5 (mm)	93 × 43.5 × 26.5 (mm)
Weight	77 g	122 g

# WARRANTY POLICY

All PENTAX cameras purchased through authorized bona fide photographic distribution channels are guaranteed against defects of material or workmanship for a period of twelve months from date of purchase. Service will be rendered, and defective parts will be replaced without cost to you within that period, provided the equipment does not show evidence of impact, sand or liquid damage, mishandling, tampering, battery or chemical corrosion, operation contrary to operating instructions, or modification by an unauthorized repair shop. The manufacturer or its authorized representatives shall not be liable for any repair or alterations except those made with its written consent and shall not be liable for damages from delay or loss of use or from other indirect or consequential damages of any kind, whether caused by defective material or workmanship or otherwise; and it is expressly agreed that the liability of the manufacturer or its representatives under all guarantees or warranties, whether expressed or implied, is strictly limited to the replacement of parts as hereinbefore provided. No refunds will be made on repairs by non-authorized PENTAX service facilities.

## Procedure During 12-month Warranty Period

Any PENTAX which proves defective during the 12-month warranty period should be returned to the dealer from whom you purchased the equipment or to the manufacturer. If there is no representative of the manufacturer in your country, send the equipment to the manufacturer, with postage prepaid. In this case, it will take a considerable length of time before the equipment can be returned to you owing to the complicated customs procedures required. If the equipment is covered by warranty, repairs will be made and parts replaced free of charge, and the equipment will be returned to you upon completion of servicing. If the equipment is not covered by warranty, regular charges of the manufacturer or of its representatives will apply. Shipping charges are to be borne by the owner. If your PENTAX was purchased outside of the country where you wish to have it serviced during the warranty period, regular handling and servicing fees may be charged by the manufacturer's representatives in that country. Notwithstanding this, your PENTAX returned to the manufacturer will be serviced free of charge according to this procedure and warranty policy. In any case, however, shipping charges and customs clearance fees to be borne by the sender. To prove the date of your purchase when required, please keep the receipt or bills covering the purchase of your equipment for at least a year. Before sending your equipment for servicing, please make sure that you are sending it to the manufacturer's authorized representatives or their approved repair shops, unless you are sending it directly to the manufacturer. Always obtain a quotation for the service charge, and only after you accept the quoted service charge, instruct the service station to proceed with the servicing.



- This warranty policy does not affect the customer's statutory rights.
- The local warranty policies available from PENTAX distributors in some countries can supersede this warranty policy. Therefore, we recommend that you review the warranty card supplied with your product at the time of purchase, or contact the PENTAX distributor in your country for more information and to receive a copy of the warranty policy.



The CE Mark is a Directive conformity mark of the European Community.

## **For customers in USA**

### **STATEMENT OF FCC COMPLIANCE**

This device complies with Part 15 of the FCC Rules. Operation is subject to the following two conditions: (1) This device may not cause harmful interference, and (2) this device must accept any interference received, including interference that may cause undesired operation.

Changes or modifications not approved by the party responsible for compliance could void the user's authority to operate the equipment.

This equipment has been tested and found to comply with the limits for a Class B digital device, pursuant to part 15 of the FCC Rules.

These limits are designed to provide reasonable protection against harmful interference in a residential installation. This equipment generates, uses and can radiate frequency energy and, if not installed and used in accordance with the instructions, may cause harmful interference to radio communications. However, there is no guarantee that interference will not occur in a particular installation.

If this equipment does cause harmful interference to radio or television reception, which can be determined by turning the equipment off and on, the user is encouraged to try to correct the interference by one or more of the following measures:

- Reorient or relocate the receiving antenna.  
Increase the separation between the equipment and receiver.  
Connect the equipment into an outlet on a circuit different from that to which the receiver is connected.
- \* Consult the dealer or an experienced radio/TV technician for help.

## **For customers in Canada**

This Class B digital apparatus meets all requirements of the Canadian Interference - Causing Equipment Regulations.

## **Pour les utilisateurs au Canada**

Cet appareil numérique de la classe B respecte toutes les exigences du Règlement sur le matériel brouilleur du Canada.

**Declaration of Conformity**  
According to 47CFR, Parts 2 and 15 for  
**Class B Personal Computers and Peripherals**

We: PENTAX U.S.A., Inc.

Located at: 600 12<sup>th</sup> Street, Suite 300  
Golden, Colorado 80401 U.S.A.  
Phone: 303-799-8000 FAX: 303-790-1131

Declare under sole responsibility that the product identified herein, complies with 47CFR Parts 2 and 15 of the FCC rules as a Class B digital device. Each product marketed is identical to the representative unit tested and found to be compliant with the standards. Records maintained continue to reflect the equipment being produced can be expected to be within the variation accepted, due to quantity production and testing on the statistical basis as required by 47CFR §2.909. Operation is subject to the following two conditions: (1) This device may not cause harmful interference, and (2) This device must accept any interference received, including interference that may cause undesired operation. The above named party is responsible for ensuring that the equipment complies with the standards of 47CFR §15.101 to §15.109.

Product Name: PENTAX Digital Still Camera

Model Number: Optio S4i

Contact person: Customer Service Manager

Date and Place: February, 2004, Colorado