

PENTAX™

Digital Camera

Optio M10

Operating Manual

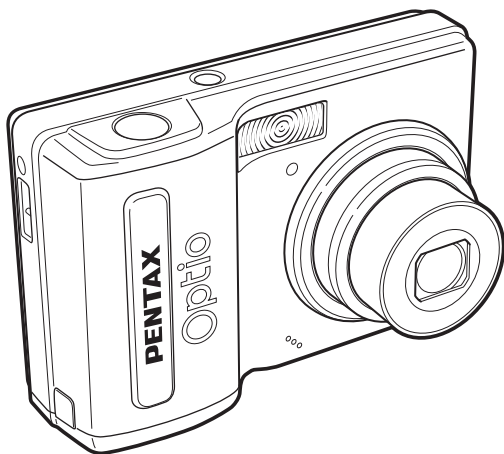

To ensure the best performance from your camera, please read the Operating Manual before using the camera.

Thank you for buying the PENTAX Digital Camera.

Please read this manual before using the camera in order to get the most out of all the features and functions. Keep this manual safe, as it can be a valuable tool in helping you to understand all the camera's capabilities.

Regarding copyrights

Images taken using the PENTAX Digital Camera that are for anything other than personal enjoyment cannot be used without permission according to the rights as specified in the Copyright Act. Please take care, as there are even cases where limitations are placed on taking pictures even for personal enjoyment during demonstrations, performances or of items on display. Images taken with the purpose of obtaining copyrights also cannot be used outside the scope of use of the copyright as laid out in the Copyright Act, and care should be taken here also.

Regarding trademarks

- PENTAX and Optio are trademarks of PENTAX Corporation.
- The SD logo  is a trademark.
- QuickTime™ and QuickTime logo are trademarks used under license. The QuickTime logo is registered in U.S. and other countries.
- All other brands or product names are trademarks or registered trademarks of their respective owners.

To users of this camera

- There is a possibility that recorded data may be erased or that the camera may not function correctly when used in surroundings such as installations generating strong electromagnetic radiation or magnetic fields.
- The liquid crystal panel used in the LCD display is manufactured using extremely high precision technology. Although the level of functioning pixels is 99.99% or better, you should be aware that 0.01% or fewer of the pixels may not illuminate or may illuminate when they should not. However, this has no effect on the recorded image.

This product supports PRINT Image Matching III, PRINT Image Matching enabled digital still cameras, printers and software help photographers to produce images more faithful to their intentions. Some functions are not available on printers that are not PRINT Image Matching III compliant.

Copyright 2001 Seiko Epson Corporation. All Right Reserved.

PRINT Image Matching is a trademark of Seiko Epson Corporation. The PRINT Image Matching logo is a trademark of Seiko Epson Corporation.

Regarding PictBridge

PictBridge allows the user to connect the printer and digital camera directly, using the unified standard for the direct printout of images. You can print images directly from the camera through a few simple operations.

Regarding ImageLink

ImageLink and the ImageLink print system logo are trademarks of Eastman Kodak Company used under license.

- There is a possibility that the illustrations and the display screen of the LCD monitor in this manual are different from the actual product.

Regarding Product Registration

In order to better service you, we request that you complete the product registration, which can be found on the CD-ROM supplied with the camera or the PENTAX website. Thank you for your cooperation.

Refer to the PC Connection Manual (bottom right of the front side) for more information.

FOR SAFE USE OF YOUR CAMERA

Sufficient attention has been paid to the safety of this product but please pay particular attention to the warnings indicated by the following symbols during use.



Warning

These symbols indicate that it is possible that the user may experience serious difficulties if the warnings are not heeded.



Caution

These symbols indicate that it is possible that the user may experience minor or middling difficulties or physical difficulties if the warnings are not heeded.

About the Camera



Warning

- Do not attempt to take the camera apart or remodel the camera. High voltages are present within the camera, and there is therefore a danger of electric shocks if the camera is taken apart.
- If the inside of the camera should become exposed as a result of, for example, the camera being dropped, please do not under any circumstances touch such exposed portions, as there is a danger of receiving an electric shock.
- To avoid the risk of it being swallowed by mistake, keep the SD Memory Card out of the reach of small children. Seek medical attention immediately if a card is accidentally swallowed.
- Wrapping the strap of the camera around your neck is also dangerous. Please take care that small children do not hang the strap around their necks.
- Use an AC adapter that is of the power and voltage specified for exclusive use with this product. The use of an AC adapter other than that specified exclusively for use with this product may cause fire or electric shocks.
- If the camera emits smoke or a strange smell, or in the event of any other irregularity, stop using the camera immediately, remove the batteries or unplug the AC adapter, and contact your nearest PENTAX Service Center. Continued use of the camera may result in fire or electric shock.

Caution

- Never try to disassemble or short the batteries. Also, do not dispose of the batteries in a fire, as they may explode.
- Do not charge any batteries other than rechargeable Ni-MH batteries. The batteries could explode or catch fire. Batteries for use with this camera other than Ni-MH batteries cannot be charged.
- Do not place your finger on the flash when it is discharging as there is a risk of burns.
- Do not discharge the flash while it is touching your clothing as there is a risk of discoloring.
- If any of the battery leakage should come in contact with your eyes, do not rub them. Flush your eyes with clean water and get medical attention immediately.
- If any of the battery leakage should come in contact with skin or clothes, wash the affected areas thoroughly with water.
- Remove the batteries from the camera immediately if it becomes hot or begins to smoke. Be careful not to burn yourself during removal.
- Some portions of the camera heat up during use, so please take care, as there is a risk of low temperature burns if such portions are held for long periods of time.
- Should the LCD be damaged, be careful of glass fragments. Also, be careful not to allow the liquid crystal to get on your skin or in your eyes or in your mouth.

Handling Precautions for Batteries

- This camera uses two AA alkaline, AA lithium, AA Ni-MH or AA nickel manganese batteries. Do not use batteries other than those specified here. Using some other type of battery may cause the camera to function poorly, or the batteries may rupture or cause a fire.
- AA alkaline, AA lithium and AA nickel manganese batteries cannot be recharged. Do not try to take the batteries apart. The batteries may rupture or leak if you try to charge them or take them apart.
- When replacing the batteries, do not combine different brands, types or capacities. Also, do not combine old batteries with new ones. Doing so may cause the batteries to rupture or cause a fire.
- Do not insert the batteries with the positive (+) and negative (–) poles in the wrong orientation. Doing so may cause the batteries to rupture or cause a fire.

About the AC Adapter

Caution



- Do not place heavy objects on the AC plug cord, allow heavy objects to drop onto it or allow the AC plug cord to become damaged due to excessive bending. If the AC plug cord becomes damaged, consult a PENTAX Service Center.
- Do not short or touch the output terminals of the product while it is still plugged in.
- Do not plug in the AC plug cord with wet hands. This can cause an electrical shock.
- Do not subject the product to strong impacts or allow it to drop onto a hard surface. This can cause a malfunction.

Care to be Taken During Handling



- Take the Worldwide Service Network listing that is included in the package with you when traveling. This will be useful if you experience problems abroad.
- When the camera has not been used for a long time, confirm that it is still working properly, particularly prior to taking important pictures (such as at a wedding or during traveling). Contents of the recording cannot be guaranteed if recording, playback or transferring your data to a computer, etc. is not possible due to a malfunction of your camera or recording media (SD Memory Card), etc.
- The lens on this camera is not interchangeable. The lens is not removable.
- Do not clean the product with organic solvents such as thinner, alcohol or benzene.
- Places of high temperature and humidity should be avoided. Particular care should be taken regarding vehicles, which can become very hot inside.
- Storing the camera where pesticides and chemicals are handled should be avoided. Remove from case and store in a well-ventilated place to prevent the camera from becoming moldy during storage.
- As this camera is not waterproof, do not use the camera where it may come in contact with rain, water or any other liquid.
- Ensure that the camera is not subjected to substantial vibrations, shock, or pressure. Use a cushion to protect the camera when it is subjected to the vibrations of a motorbike, car, ship, etc.
- The temperature range in which the camera can be used is 0°C to 40°C (32°F to 104°F).

- The liquid crystal display will become black at a high temperature but will return to normal when normal temperatures are returned to.
- The response speed of the liquid crystal display becomes slow at low temperatures. This is due to the properties of the liquid crystal and is not a fault.
- Periodic checks are recommended every 1 to 2 years in order to maintain high performance.
- If the camera is subjected to rapid temperature changes, condensation may form on the inside and outside of the camera. Therefore put the camera in a bag or plastic bag, and take the camera out when the difference in temperature has subsided.
- Be careful not to allow dirt, mud, sand, dust, water, toxic gases or salt to enter the camera as this may damage the camera. Wipe away any raindrops or water droplets and allow the camera to dry.
- Refer to “Precautions When Using an SD Memory Card” (p.28) regarding the SD Memory Card.
- Please note that formatting an SD memory card or built-in memory will delete all data; however it may still be possible to recover that data using off-the-shelf data recovery software. Please manage your camera’s memory at your own risk.
- Please do not press forcefully on the LCD monitor. This could cause breakage or malfunction.
- Be careful not to sit down with the camera in your back pocket as this may damage the exterior of the camera or the LCD monitor.
- When using a tripod with the camera, be careful not to overtighten the screw in the tripod socket on the camera.

Contents















FOR SAFE USE OF YOUR CAMERA	1
Care to be Taken During Handling	3
Contents	5
Composition of the Operating Manual	11
Camera Features	12
Checking the Contents of the Package	14
Names of Parts	15
Names of Operating Parts	16
Monitor Indications	16
Getting Started	19
<hr/>	
Attaching the Strap	19
Powering the Camera	20
Installing the Batteries	20
Using the AC Adapter with a Household Power Supply	23
Using the AC Adapter Abroad	24
Installing the SD Memory Card	26
Recorded Pixels and Quality Level of Still Pictures	29
Recorded Pixels and Frame Rate of Movies	31
Turning the Camera On and Off	32
Playback Only Mode	33
Initial Settings	34
Setting the Display Language	34
Setting the Date and Time	36
Quick Start	38
<hr/>	
Taking Still Pictures	38
Playing Back Still Pictures	40
Playing Back Images	40
Playing Back the Previous or Next Image	40
Rotating the Displayed Image	41
Common Operations	42
<hr/>	
Understanding the Button Functions	42
 Mode	42
 Mode	44

Setting the Camera Functions	46
Setting with the Menu	46
Menu List	49
Setting the Shooting Mode	51
Setting the Playback Mode	55
Taking Pictures	57
<hr/>	
Taking Pictures	57
Letting the Camera Choose the Optimal Settings (Program Mode)	57
Taking Pictures in the Basic Mode (Green Mode)	58
Taking Pictures of Dark Scenes (Night Scene/Fireworks Mode)....	60
Taking Pictures of Your Pet (Pet Mode)	61
Using the Self-timer	62
Taking a Series of Pictures	63
Framing Your Pictures	64
Using the Zoom	66
Setting the Exposure (EV Compensation)	68
Displaying Shooting Information in Capture Mode	69
Setting the Shooting Functions	71
Selecting the Focus Mode	71
Selecting the Flash Mode	73
Selecting the Recorded Pixels	75
Selecting the Quality Level	77
Adjusting the White Balance	78
Changing the Focusing Area	80
Setting the Sensitivity	81
Setting the Instant Review Time (Instant Review)	82
Setting the Image Sharpness (Sharpness)	83
Setting the Color Saturation (Saturation)	84
Setting the Image Contrast (Contrast)	85
Saving the Settings (Memory)	86
Recording Movies	88
Recording a Movie	88
Selecting the Recorded Pixels for Movies	90
Recording Movies in Black and White or Sepia Tones (Color Mode)	91
Selecting the Frame Rate	92

Playing Back Images	93
To Switch Between  Mode and  Mode	93
Playing Back Still Pictures	93
Nine-Image Display and Folder Display	94
Zoom Playback	96
Displaying Shooting Information in Playback Mode	98
Slideshow	99
Playing Back Movies	101
Playing Back a Movie	101
Connecting the Camera to AV Equipment	102
Deleting Images	103
Deleting Single Images/Sound Files.....	103
Deleting Selected Images and Sound Files (from Nine-Image Display).....	105
Deleting All Images.....	107
Protecting Images and Sound Files from Deletion (Protect)	108
Editing and Printing Images	110
Editing Images	110
Changing the Image Size and Quality (Resize).....	110
Trimming Images	112
Copying Images and Sound Files.....	113
Setting the Printing Service (DPOF)	115
Printing Single Images.....	115
Printing All Images.....	117
Printing Using PictBridge	118
Connecting the Camera to the Printer	118
Printing Single Images.....	119
Printing All Images.....	121
Printing Using the DPOF Settings	122
Disconnecting the Cable from the Printer	122
Printing Using ImageLink.....	123
Recording and Playing Back Sound	124
Recording Sound (Voice Recording Mode)	124
Playing Back Sound	126
Adding a Voice Memo to Images	127
Recording a Voice Memo	127
Playing Back a Voice Memo	128

Camera Settings	129
Formatting an SD Memory Card or the Built-in Memory	129
Changing the Sound Settings.....	130
Changing the Start-up Screen	132
Changing the Date and Time.....	133
Changing the Display Language	135
Changing the Image Folder Name	136
Changing the USB Connection Mode.....	137
Changing the Video Output Format.....	138
Automatically Adjusting the Brightness of the LCD Monitor (Auto LCD Dimmer).....	139
Setting Auto Power Off	140
Resetting to Default Settings (Reset)	141
Appendix	142
Default Settings	142
Functions Available for Each Shooting Mode	145
Optional Accessories	146
Messages	147
Troubleshooting	149
Main Specifications	151
WARRANTY POLICY	155
Index	160

The meanings of the symbols used in this operating manual are explained below.

	indicates the reference page number for an explanation of the related operation.
	indicates information that is useful to know.
	indicates precautions to be taken when operating the camera.
 mode	This is the mode for capturing still pictures and recording movies and sound files. In this manual, the mode for taking still pictures is referred to as the “Still Picture Capture Mode”, the mode for recording movies is referred to as the “  mode” and the mode for recording sound files is referred to as the “  mode”.
 mode	This is the mode for viewing still pictures and playing back movies and sound files.
 SOFT ,    	The icons above the title show the shooting modes that can activate the function. Ex.   Setting the Image Sharpness (Sharpness)

Memo

Composition of the Operating Manual

This operating manual contains the following chapters.

1 Getting Started

This chapter explains what you need to do after purchasing the camera before you start taking pictures. Be sure to read it and follow the instructions.

2 Quick Start

This chapter explains the simplest way to take pictures and play back images. Use it if you want to start taking pictures or playing back images straightaway.

3 Common Operations

This chapter explains common operations such as the functions of the buttons and how to use the menus. For more details, refer to the respective chapters below.

4 Taking Pictures

This chapter explains the various ways of capturing images and how to set the relevant functions.

5 Playing Back and Deleting Images

This chapter explains how to view still pictures and movies on the camera or on a TV and how to delete images from the camera.

6 Editing and Printing Images

This chapter explains the various ways of printing still pictures and how to edit images with the camera. Refer to the PC Connection Manual for instructions on saving images to a computer and installing ACDSee for PENTAX, and refer to ACDSee for PENTAX Help for instructions on editing and printing images with a computer.

7 Recording and Playing Back Sound

This chapter explains how to record sound files or add sound (a voice memo) to an image, and how to play back sound files.

8 Settings

This chapter explains how to set the camera-related functions.

9 Appendix

This section deals with troubleshooting and lists the optional accessories.

1

2

3

4

5

6

7

8

9

Camera Features

In addition to basic picture-taking, the Optio M10 has a variety of shooting modes to suit different situations. This section describes how to make the most of the key features of your camera. Together with the explanations of camera operations, it will enable you to enjoy your camera to the full.

Easy-to-Navigate Capture and Playback Functions!



The user-friendly design of the Optio M10 enables easy operation with only a few buttons. Simply by choosing the appropriate icon, you can select Shooting mode (p.51) and choose the optimal settings for the situation, or Playback mode (p.93, p.110) and enjoy the various playback and editing functions. Use the Capture Mode Palette in Capture mode to choose from 15 shooting modes. Capture still images, video and audio of your frolicking puppy, a beautiful fireworks display and other special moments.

A guide on the LCD monitor lets you check the functions available in each mode and how to use them. (p.56)

- **Let the camera choose the optimal settings.**
- **Use the Green Mode to take pictures easily using standard settings. (p.58)**
- **Press the Green button while the Mode Palette is displayed to display the guide. (p.56)**

Choose a Frame Before Taking the Picture!

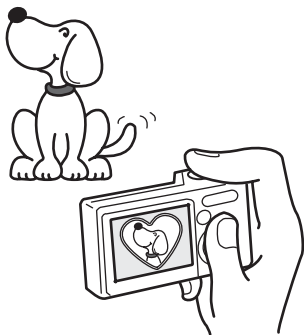

The Optio M10 lets you choose a frame and display it on the screen before you take the picture, so you can be sure that the frame complements your subject perfectly. (p.64)

- For decorating your pictures with a frame.

Easy Printing without Using a Computer!

By connecting the camera to a printer that supports PictBridge using the USB cable, you can print images directly from the camera. In addition, by placing the supplied dock insert onto a Kodak EasyShare Printer Dock and then placing the camera on the printer dock, anyone can enjoy easily printing out images with the touch of a single button.

Gone are the days of not being able to print out pictures at home because operating the computer was too difficult!

- Easily print out images without using a computer.

Checking the Contents of the Package



Camera
Optio M10

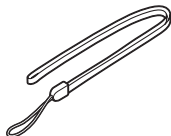

Strap
O-ST51 (*)

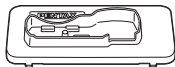

Dock insert
O-DI51

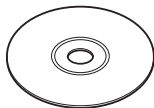

Software (CD-ROM)
S-SW48

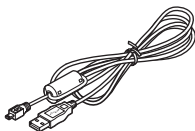

USB cable
I-USB7 (*)

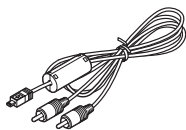

AV cable
I-AVC7 (*)



Two AA
alkaline batteries

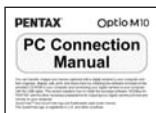

PC Connection Manual



Operating Manual
(this manual)

Items marked with an asterisk (*) are also available as optional accessories. For other optional accessories, refer to "Optional Accessories" (p.146).

Names of Parts

Front

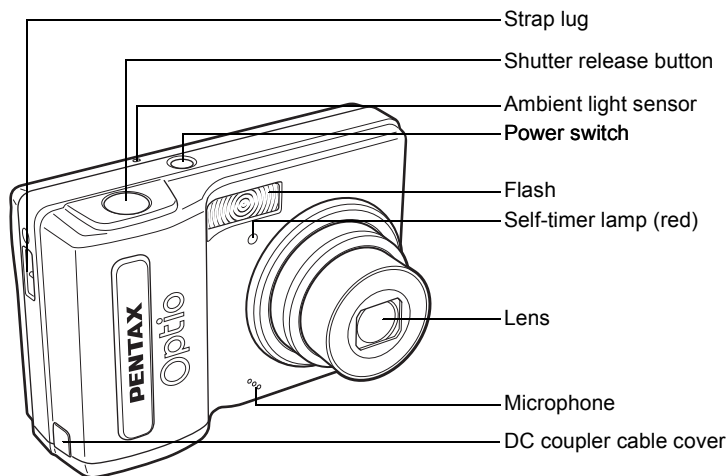

Back

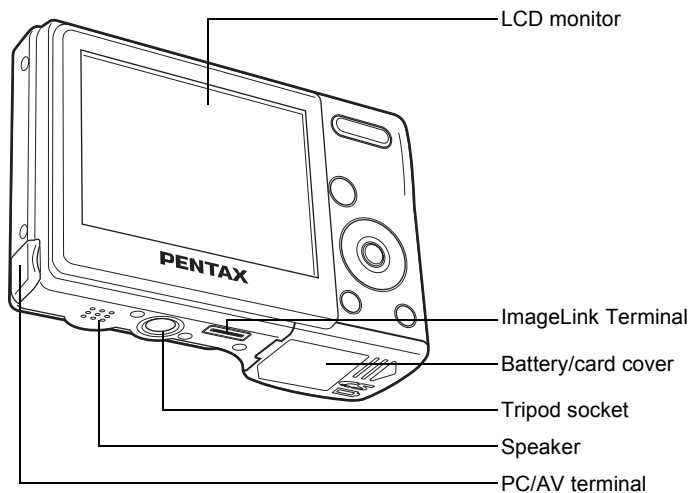

Names of Operating Parts

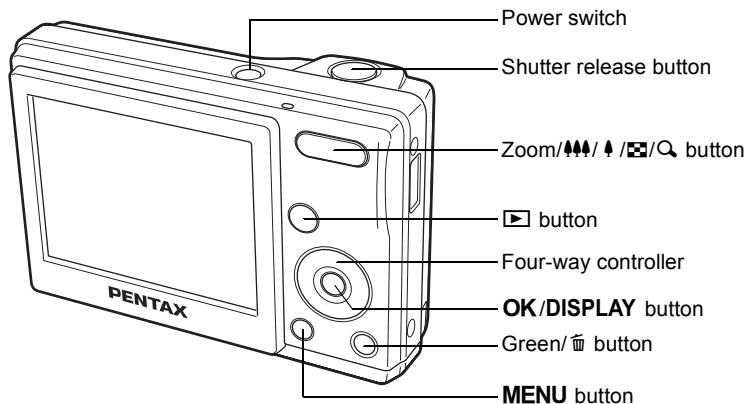





Refer to Understanding the Button Functions (p.42 - p.45) for an explanation of the function of each button.

Monitor Indications

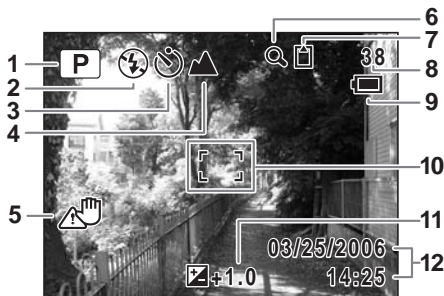
Normal Display in Still Picture Capture Mode

The display shows information such as the shooting conditions.



- | | |
|---|------------------------------------|
| 1 Shooting mode (p.51) | 8 Remaining image storage capacity |
| 2 Flash mode (p.73) | 9 Battery indicator (p.22) |
| 3 Drive mode (p.62, p.63, p.64) | 10 Focus frame (p.38) |
| 4 Focus mode (p.71) | 11 EV compensation (p.68) |
| 5 Camera shake icon (p.69) | 12 Date and time (p.36) |
| 6 Digital zoom icon (p.66) | |
| 7 Memory status (p.32) | |
|  : Built-in memory
(without card) | |
|  : SD Memory Card | |
|  : Card is write-protected | |

Full Display in Still Picture Capture Mode



- | | |
|--------------------------------|------------------------|
| 1 Bright portion (blinks red) | 6 Quality (p.77) |
| 2 Dark portion (blinks yellow) | 7 White balance (p.78) |
| 3 Shutter speed | 8 Sensitivity (p.81) |
| 4 Aperture | 9 Histogram (p.70) |
| 5 Recorded pixels (p.75) | |

About the Bright and Dark Portions

When there is an area in the frame that is so bright it appears white, the indicated area blinks red as a warning. Similarly, when there is an area that is so dark it appears black, the indicated area blinks yellow as a warning.

Full Display in Still Picture Playback Mode

(All of the display items are displayed here for explanatory purposes.)

The display shows information such as the shooting conditions. A1 to A11 appear when [Normal Display] or [Histogram + Info] is selected. B1 to B9 only appear when [Histogram + Info] is selected. (p.98)

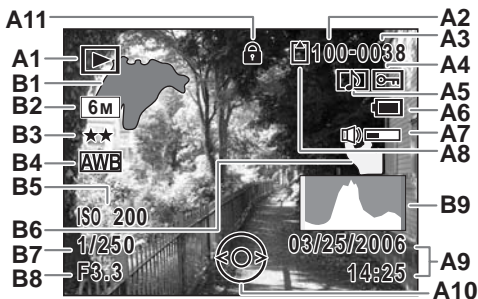

- | | |
|---|---|
| A1 Playback mode (p.55) | A10 Four-way controller guide |
| A2 Folder number (p.136) | A11 Key lock icon (p.58) |
| A3 File number | B1 Bright portion (blinks red) (p.17) |
| A4 Protect icon (p.108) | B2 Recorded pixels (p.75) |
| A5 Voice memo icon (p.128) | B3 Quality (p.77) |
| A6 Battery indicator (p.22) | B4 White balance (p.78) |
| A7 Volume icon (p.128) | B5 Sensitivity (p.81) |
| A8 Memory status (p.32) | B6 Dark portion (blinks yellow) (p.17) |
| : Built-in memory (without card) | B7 Shutter speed |
| : SD Memory Card | B8 Aperture |
| : Card is write-protected | B9 Histogram (p.70) |
| A9 Captured date and time (p.36) | |

In Normal Display, A6 and A9 disappear if no operation is performed in two seconds.

Guide Indications

A guide to available button operations appears on the LCD monitor during operation.

The buttons are indicated as shown below.

Four-way controller (▲)	▲
Four-way controller (▼)	▼
Four-way controller (◀)	◀
Four-way controller (▶)	▶
MENU button	

Zoom button	
OK/DISPLAY button	
Shutter release button	
Green/ button	

Attaching the Strap

Attach the strap (O-ST51) supplied with the camera.

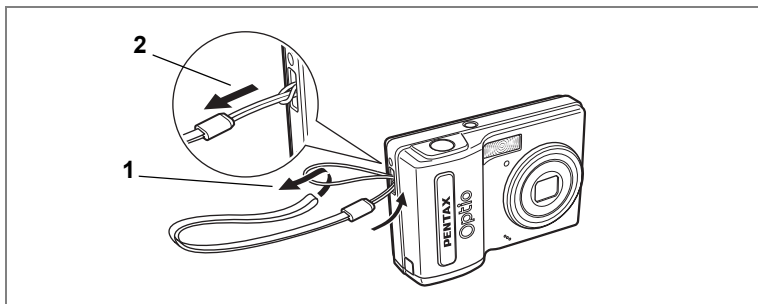

- 1** Pass the narrow end of the strap through the strap lug.
- 2** Pass the other end of the strap through the loop and pull tight.

Powering the Camera

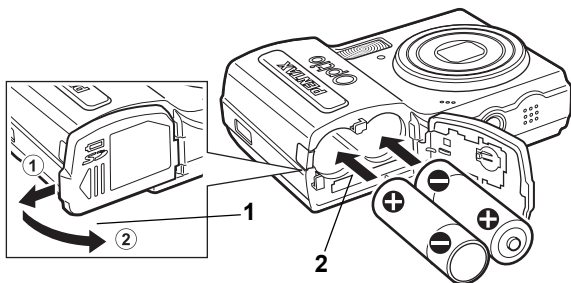

Installing the Batteries

Install the batteries into the camera. Use two AA alkaline, AA lithium, AA Ni-MH, or AA nickel manganese batteries.

1 Open the battery/card cover.

Pull the battery/card cover in the direction of ① and flip the cover open in the direction of ②.

2 Insert the batteries, making sure the (+) and (-) on the batteries match the (+) and (-) inside the battery compartment.

3 Close the battery/card cover and slide it back into place.



- Use the AC adapter kit K-AC51 (optional) if you intend to use the camera for a long time. (p.23)



- AA alkaline, AA lithium and AA nickel manganese batteries are not rechargeable.
- Do not open the battery/card cover or remove the batteries while the camera is turned on.
- If you do not intend to use the camera for a long time, remove the batteries. If the batteries are left in the camera for a long time, they may leak.
- If the batteries have been removed from the camera for a long time, when they are reinserted and the camera is turned on, the message [Battery depleted] may appear. This can also happen when using the camera for the first time; however this is not a malfunction. Wait a minute and then turn the camera on again to reset the camera. The date and time may also be reset.
- Insert the batteries correctly. If the batteries are incorrectly oriented, malfunction may result. Wipe the ends of the batteries and insert them into the camera.

• Image Storage Capacity, Movie Recording Time, Sound Recording Time, and Playback Time

(at 23°C with the LCD monitor on and fresh batteries inserted)

The number of recordable images and playback time for different types of batteries.

Battery Type	Image Storage Capacity* ¹	Movie Recording Time* ²	Sound Recording Time* ²	Playback Time* ²
AA lithium batteries	900 pictures	310 min.	1340 min.	850 min.
AA NiMH batteries	640 pictures	230 min.	740 min.	660 min.
AA nickel manganese batteries	430 pictures	120 min.	540 min.	490 min.
AA alkaline batteries	220 pictures	90 min.	430 min.	380 min.

*1: Recording capacity shows approximate number of shots recorded during CIPA-compliant testing (with LCD monitor on, flash used for 50% of the shots, and 23 degrees centigrade). Actual performance may vary according to operating conditions.





*2: According to the result of in-house testing.





- In general, battery performance may temporarily deteriorate as the temperature decreases. Be sure to take spare batteries when using the camera in a cold region and keep the batteries warm by placing them in your pocket or inside your coat. Battery performance that has deteriorated due to cold temperature will return to normal performance when the batteries reach room temperature.
- Due to their characteristics, AA alkaline batteries may not allow the camera to make full use of its capabilities, and therefore they are not recommended except for emergency use.
- Due to their characteristics, AA alkaline batteries and nickel manganese batteries may not allow the camera to make full use of its capabilities when used at cold temperatures. Use of AA lithium batteries is recommended when the camera is used at cold temperatures.
- Be sure to take spare batteries with you when traveling abroad or to a cold region, or if you intend to take a lot of pictures.

• Battery Level Indicator

You can check the battery level by the  indicator on the LCD monitor.

Screen Display	Battery Status
 (green)	Adequate power remains.
 (green)	Batteries are running low.
 (yellow)	Batteries are running very low.
 (red)	Batteries are exhausted.
[Battery depleted]	The camera will turn off after this message appears.



Due to the characteristics of AA nickel manganese batteries, the battery level may not be displayed correctly when using these batteries.  may be displayed for the battery level even if the batteries are running low. The camera may also turn off without warning even if  is displayed.

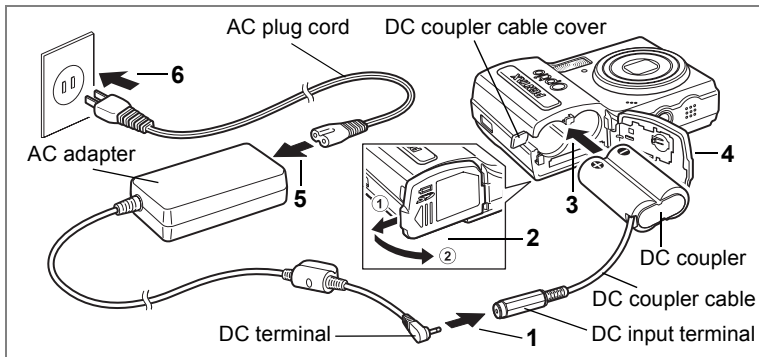

Using the AC Adapter with a Household Power Supply

Use of the AC adapter kit K-AC51 (optional) with a household power supply is recommended if you intend to use the camera for a long time or connect it to a computer.

(The AC adapter kit K-AC51 includes AC adapter D-AC5, DC coupler D-DC51, and AC plug cord D-CO2.)

- 1** Connect the DC terminal of the AC adapter to the DC input terminal of the DC coupler.
- 2** Make sure that the camera is turned off and open the battery/card cover.
Pull the battery/card cover in the direction of ① and flip the cover open in the direction of ②.
- 3** Insert the DC coupler into the battery compartment, making sure the (+) and (-) on the coupler match the (+) and (-) on the battery compartment.
- 4** Open the DC coupler cable cover, pass the DC coupler cable through the opening, and close the battery/card cover.
Slide the battery/card cover in the opposite direction of ①. Slide the battery/card cover all the way in to make sure it is securely closed.
- 5** Connect the AC plug cord to the AC adapter.
- 6** Plug the AC plug cord into the power outlet.



- Make sure that the camera is turned off before connecting or disconnecting the AC adapter.
- Make sure that the AC plug cord and the power cord connecting the AC adapter to the camera are inserted securely. The data may become lost if either cord becomes disconnected while data is being recorded.
- Use the AC adapter with due care to avoid fire or electric shock. Be sure to read “FOR SAFE USE OF YOUR CAMERA” (p.1) before using the AC adapter.
- Be sure to read the operation manual accompanying the AC adapter kit K-AC51 before using the adapter.

Using the AC Adapter Abroad

The AC adapter kit K-AC51 (optional) is designed to switch automatically to the voltage (100-240V) and frequency (50Hz, 60Hz) of the electricity supply in the country or region where used.

However, electrical socket shapes differ from country to country. Before traveling abroad, you are advised to check the socket shape in the country of your destination (see “Main Socket Types in the Major Countries and Regions of the World” (p.25)) and take an appropriately shaped adapter plug with you.

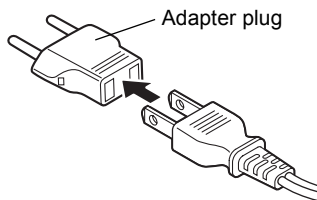

- Use of an off-the-shelf transformer may lead to defective operation.
- Unplug the adapter plug from the power outlet when not in use.

Type	A	B	BF	C	S
Shape					
Adapter plug	—				

Main Socket Types in the Major Countries and Regions of the World

		A	B	BF	C	S
North America	U.S.A., Canada	✓				
Europe, Former Soviet Union	Iceland, Ireland, Italy, Ukraine, Austria, Netherlands, Kazakhstan, Greece, Sweden, Denmark, Germany, Norway, Hungary, Finland, France, Belarus, Belgium, Rumania, Russia				✓	
	U.K.		✓	✓		
	Spain	✓			✓	
	Switzerland, Poland, Portugal		✓		✓	
Asia	Taiwan, Japan	✓				
	Sri Lanka, Maldives		✓			
	Nepal, Bangladesh, Mongolia				✓	
	Vietnam	✓			✓	
	India, Indonesia, Pakistan, Macau		✓		✓	
	Thailand	✓		✓	✓	
	Korea	✓	✓		✓	
	Philippines	✓			✓	✓
	Singapore, Hong Kong		✓	✓		
	China	✓	✓	✓	✓	✓
Malaysia		✓	✓	✓		
Oceania	Australia, Tonga, New Zealand, Fiji					✓
	Guam	✓				
	Tahiti				✓	
Central and South America	Colombia, Jamaica, Haiti, Panama, Bahamas, Puerto Rico, Venezuela, Mexico	✓				
	Brazil, Peru	✓			✓	
	Chile		✓		✓	
	Argentina			✓	✓	✓
Middle East	Israel, Iran				✓	
	Kuwait		✓		✓	
	Jordan		✓	✓		
Africa	Canary Islands, Guinea, Mozambique, Morocco				✓	
	Kenya, South Africa		✓		✓	
	Algeria	✓	✓	✓		
	Egypt		✓	✓	✓	
	Zambia, Tanzania		✓	✓		

Installing the SD Memory Card

1

Getting Started

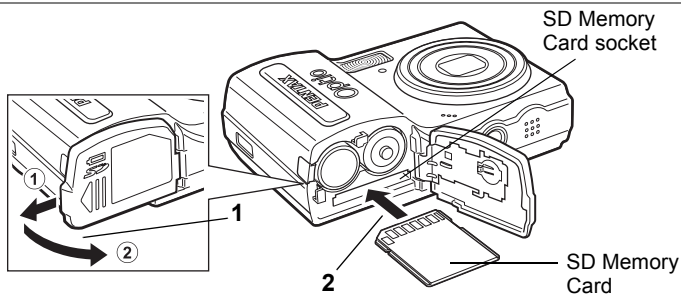

This camera uses an SD Memory Card. Captured images and sound files are saved on the SD Memory Card if a card is inserted in the camera. They are saved in the built-in memory if a card is not inserted. (p.32)



- **Be sure to use this camera to format an SD Memory Card that is unused or has been used on another camera. Refer to “Formatting an SD Memory Card or the Built-in Memory” (p.129) for instructions on formatting.**
- Make sure that the camera is turned off before inserting or removing the SD Memory Card.



The still picture storage capacity varies depending on the capacity of the SD Memory Card and the selected number of recorded pixels and quality level. (p.29)

Backing Up Data

The camera may not be able to access data in the built-in memory in the case of a malfunction. Use a computer or other device to back up important data in another location.

1 Open the battery/card cover.

Pull the battery/card cover in the direction of ① and flip the cover open in the direction of ②.



2 Insert the SD Memory Card into the SD Memory Card socket so that the label is facing toward the LCD monitor.

Push the card in until it clicks. Images and sound may not be recorded correctly if the card is not inserted all the way.

3 Close the battery/card cover and slide it back into place.**Removing the SD Memory Card****1 Open the battery/card cover.****2 Push the card into the SD Memory Card socket to eject it.**

Pull the card out.

Precautions When Using an SD Memory Card

- The SD Memory Card is equipped with a write-protect switch. Setting the switch to LOCK protects the existing data by prohibiting recording of new data, deletion of existing data or formatting of the card.  Write-protect switch—
 appears on the LCD monitor when the card is write-protected.
- Care should be taken when removing the SD Memory Card immediately after using the camera, as the card may be hot.
- Do not remove the SD Memory Card or turn the camera off while data is being saved to the card, images or sound files are being played back, or the camera is connected to a computer with the USB cable, as this may cause the data to be lost or the card to be damaged.
- Do not bend the SD Memory Card or subject it to violent impact. Keep it away from water and store away from high temperature.
- Do not remove the SD Memory Card during formatting as this may damage the card and render it unusable.
- The data on the SD Memory Card may be deleted in the following circumstances. PENTAX does not accept any liability for data that is deleted
 - (1) when the SD Memory Card is mishandled by the user.
 - (2) when the SD Memory Card is exposed to static electricity or electrical interference.
 - (3) when the card has not been used for a long time.
 - (4) when the card is ejected or the batteries are removed while the data on the card is being recorded or accessed.
- The SD Memory Card has a limited service life. If it is not used for a long time, the data on the card may become unreadable. Be sure to regularly make a backup of important data on a computer.
- Avoid using or storing the card where it may be exposed to static electricity or electrical interference.
- Avoid using or storing the card in direct sunlight or where it may be exposed to rapid changes in temperature or to condensation.
- When using an SD Memory Card with a slow recording speed, recording may stop while you are taking movies even when there is adequate space in the memory, or shooting and playback may take a long time.
- For information on compatible SD Memory Cards, visit the PENTAX website or contact your nearest PENTAX Service Center.

Recorded Pixels and Quality Level of Still Pictures

Choose the number of pixels (size) and quality level (data compression rate) of still pictures according to how you intend to use the pictures you have taken.

Higher quality levels and numbers of pixels produce clearer images, but the resulting increase in data volume reduces the total number of pictures that can be taken (stored in the camera's built-in memory or on the SD Memory Card).

The quality of the captured photo or printed picture also depends on the quality level, exposure compensation, resolution of the printer and a variety of other factors, so you do not need to select more than the required number of pixels. As a rough guide, **[2M]** (1600×1200) is adequate for making postcard-size prints. Refer to the table below for the appropriate settings according to use.

● Appropriate Number of Recorded Pixels According to Use

Recorded Pixels	Use	
[6M] 2816×2112	↑ Clearer	For printing high quality photos or A4-size pictures, or editing images on a PC.
[5M] 2560×1920		
[4M] 2304×1728		For making postcard-size prints.
[3M] 2048×1536		
[2M] 1600×1200		
[1024] 1024× 768		For posting on a website or attaching to e-mail.
[640] 640× 480		

The default setting is **[6M]** (2816×2112).

● Appropriate Quality Level According to Use

★★★	Best	Lowest compression rate. Suitable for photo prints.
★★	Better	Standard compression rate. Suitable for viewing the image on a computer screen.
★	Good	Highest compression rate. Suitable for posting on a website or attaching to e-mail.

The default setting is **★★ (Better)**.

Choose the appropriate number of recorded pixels and quality level for still pictures on the **[📷 Rec. Mode]** menu.

Selecting the Recorded Pixels **☞**p.75

Selecting the Quality Level **☞**p.77

● Recorded Pixels, Quality Level and Image Storage Capacity
(Approximate numbers of pictures)

		★★★ (Best)		★★ (Better)		★ (Good)	
		Built-in Memory	128MB	Built-in Memory	128MB	Built-in Memory	128MB
6M	2816×2112	7	41	14	83	22	124
5M	2560×1920	8	49	17	95	24	137
4M	2304×1728	11	62	22	124	31	178
3M	2048×1536	13	77	27	153	40	223
2M	1600×1200	22	124	37	206	54	301
1024	1024× 768	43	244	74	412	93	522
640	640× 480	87	489	127	712	175	979

- The above figures may vary depending on the subject, shooting conditions, shooting mode and SD Memory Card, etc.

Recorded Pixels and Frame Rate of Movies

Choose the recorded pixels and frame rate (number of frames per second) according to how you intend to use the movies you have taken. The higher the number of recorded pixels, the clearer the details, but the bigger the file size.

The more frames per second, the better the quality of the movie, but the bigger the file size.

Choose the appropriate number of recorded pixels and frame rate in [Movie] on the [Rec. Mode] menu.

Selecting the Recorded Pixels for Movies p.90

Selecting the Frame Rate p.92

● Appropriate Number of Recorded Pixels According to Use

(320×240)	Suitable for viewing the movie on a computer.
(160×120)	File size is smaller, but total recording time is increased. Suitable for posting on a website or attaching to e-mail.

The default setting is (320×240).

● Appropriate Frame Rate According to Use

30fps	Produces high quality movies, but reduces the total recording time.
15fps	Increases the total recording time because the file size is smaller.

The default setting is 30fps (frames per second).

● Recorded Pixels, Frame Rate and Recording Time

(Approximate recording time)

		30fps		15fps		Sound	
		Built-in Memory	128MB	Built-in Memory	128MB	Built-in Memory	128MB
320×240	33 sec.	3 min. 6 sec.	1 min. 3 sec.	5 min. 55 sec.	47 min. 57 sec.	4 hr. 27 min. 19 sec.	
160×120	2 min. 7 sec.	11 min. 51 sec.	3 min. 54 sec.	21 min. 45 sec.			

- The above figures are based on PENTAX standard shooting conditions and may vary depending on the subject, shooting conditions and type of SD Memory Card used.

Turning the Camera On and Off

1

Getting Started

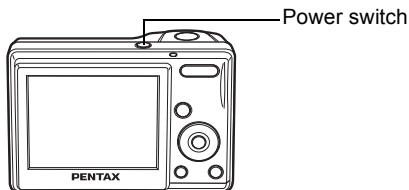

1 Press the power switch.

The camera turns on and the LCD monitor turns on. When you turn the camera on, the lens cover opens and the lens extends. If the Language Selection screen or Date Adjust screen appears when you turn the camera on, follow the procedure on p.34 to set the display language and/or current date and time.

2 Press the power switch again.

The camera and the LCD monitor turn off and the lens closes.

Taking Pictures p.57

Checking the Memory Card

The memory card is checked automatically when the camera turns on. appears on the LCD monitor when there is no SD Memory Card inserted in the camera. In this case, images and sound files will be saved in the built-in memory. appears instead of when the write-protect switch on the SD Memory Card is in the locked position. Images and sound cannot be recorded when the write-protect switch is locked.

Memory status



If the batteries have been removed from the camera for a long time, when they are reinserted and the camera is turned on, the message [Battery depleted] may appear. This can also happen when using the camera for the first time; however this is not a malfunction. Wait a minute and then turn the camera on again to reset the camera. The date and time and other settings may also be reset. Follow the procedure on p.36 to set these settings again.

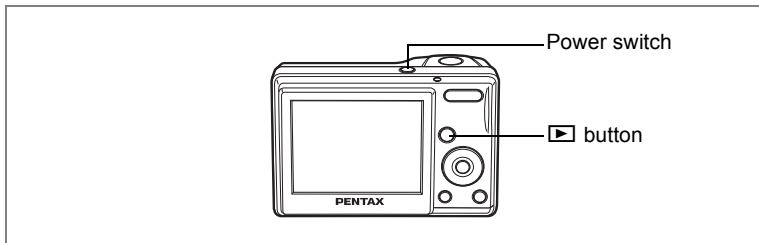



Playback Only Mode

Playback Only Mode is the Playback Mode when the lens is closed. Use this mode when you want to play back an image or sound file straightaway without taking any more pictures. Pressing the shutter release button does not change the mode to  mode.

1 Press the power switch while holding down the button.

The LCD monitor turns on while the lens is closed and the camera turns on in Playback Only Mode.



- To switch from Playback Only Mode to  mode, turn the camera off and then turn it on again.
- In Capture Mode, press the  button for more than two seconds. The camera switches to Playback Mode and the lens closes. This mode is different than Playback Only Mode, and if you press the  button again or press the shutter release button, the camera switches to Capture Mode.

Playing Back Still Pictures  p.40

Initial Settings

1

Getting Started

Set the language, time, and date after purchasing the camera before you start taking pictures.

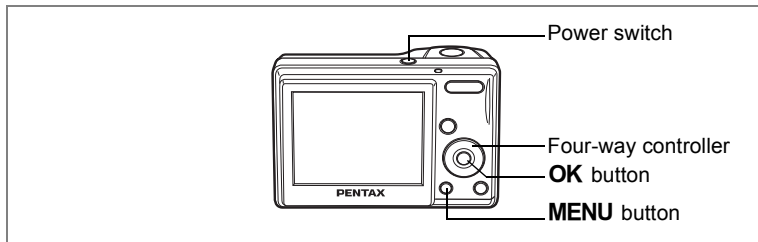

The Language Selection screen appears when the camera is turned on for the first time. Perform the operations in “Setting the Display Language” below to set the language, and in “Setting the Date and Time” (p.36) to set the current date and time. Go to “Setting the Date and Time” (p.36) when the Date Adjust screen appears.

Language, Date, and Time can be changed. Refer to the pages below for instructions.

- To change the language, follow the steps in “Changing the Display Language” (p.135).
- To change the date and time, follow the steps in “Changing the Date and Time” (p.133).

Setting the Display Language

- 1 Use the four-way controller (▲▼◀▶) to choose the display language.**

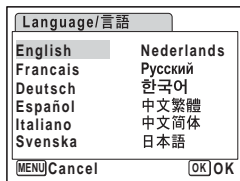

- 2 Press the OK button.**

The Date Adjust screen appears.

Next, set the date style and the current date and time using the steps in “Setting the Date and Time” (p.36-37).

If the **OK** button was accidentally pressed in another language, perform the following operation to set the language back.

- 1 Press the OK button once.**
- 2 Press the MENU button.**
- 3 Press the four-way controller (▶).**
- 4 Use the four-way controller (▲ ▼) to select [Language/言語].**
- 5 Press the four-way controller (▶).**

The Language/言語 screen appears.

- 6 Use the four-way controller (▲ ▼ ◀ ▶) to select the language.**

- 7 Press the OK button.**

The [Y Setting] screen for the set language appears.

The language is now switched to your desired language.

Date and time are set to correspond to the language mistakenly set previously. Follow the steps in "Changing the Date and Time" (p.133) to set the current date and time.

Setting the Date and Time

Set the current date and time and the display style.

- 1 Press the four-way controller (▶).**

The frame moves to [mm/dd/yy].

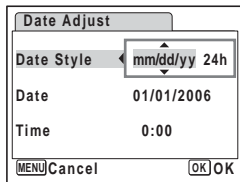

- 2 Use the four-way controller (▲▼) to choose the date and time display style.**

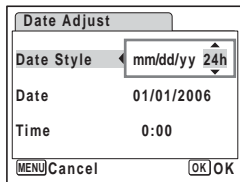

- 3 Press the four-way controller (▶).**

The frame moves to [24h].

- 4 Use the four-way controller (▲▼) to select [24h] (24-hour display) or [12h] (12-hour display).**

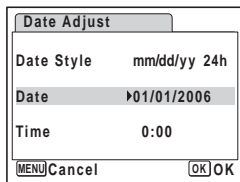

- 5 Press the four-way controller (▶).**

The frame returns to [Date Style].

- 6 Press the four-way controller (▼).**

The frame moves to [Date].

- 7 Press the four-way controller (▶).**

The frame moves to the month.

- 8 Use the four-way controller (▲▼) to change the month.**

Change the day and year in the same manner. Next, change the time.

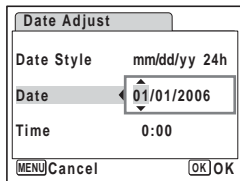

If you selected [12h] in Step 4, the setting switches between am and pm corresponding to the time.

9 Press the **OK** button.

The camera returns to capture status.

Language, Date and Time can be changed. Refer to the pages below for instructions.

- To change the language, follow the steps in “Changing the Display Language” (p.135).
- To change the date and time, follow the steps in “Changing the Date and Time” (p.133).



When the Initial Setting or Date Adjust screen is displayed, you can cancel the setting operation and switch to Capture mode by pressing the **MENU** button. In this case, the Initial Setting screen will appear next time you turn the camera on.



If you press the **OK** button in Step 9, the camera clock is reset to 00 seconds. To set the exact time, press the **OK** button when the time signal (on the TV, radio, etc.) reaches 00 seconds.

The video output format is set to the format of the country or region selected in [Language/言語] on the Initial Setting screen. You can change the setting. (p.138)

Taking Still Pictures

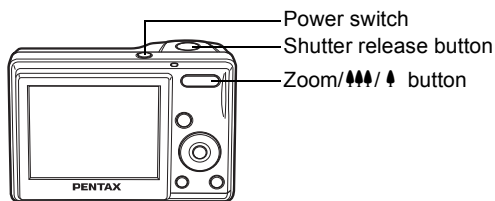

The standard procedure for taking still pictures is described below. The flash fires automatically depending on the light conditions.

1 Press the power switch.

The camera turns on and is ready to take still pictures. In this manual, this is called Still Picture Capture Mode.

2 Confirm the subject and shooting information on the LCD monitor.

The focus frame in the middle of the LCD monitor indicates the zone of automatic focusing.

You can change the captured area by pressing the Zoom/▲▲▲/▲ button to the left or right.

▲ : enlarges the subject

▲▲▲ : widens the area that is captured by the camera

3 Press the shutter release button halfway.

The focus frame on the LCD monitor turns green if the subject is in focus.

4 Press the shutter release button fully.

The picture is taken.

The image appears on the LCD monitor for one second (Instant Review) and is saved to the SD Memory Card or built-in memory. (p.39)



Focus frame



Press the Green button to switch to the Green Mode and let the camera set all the shooting functions automatically. Selecting the Green Mode is the easiest way to ensure that pictures come out well. (p.58)

Using the Shutter Release Button

The shutter release button works in a two-step action as follows.

Press halfway

The focus and exposure are locked when the shutter release button is pressed halfway. The green focus frame lights on the LCD monitor when the shutter release button is pressed halfway and the subject is in focus. If the subject is out of focus, the frame will light red.

Press fully

Press the shutter release button all the way down to take the picture.

[Poor focusing conditions]

The camera may not be able to focus under the following conditions. In this case, lock the focus on an object the same distance away as the subject (by pressing the shutter release button halfway), then aim the camera at your subject and press the shutter release button fully.

- Objects that lack contrast such as a blue sky or white wall
- Dark places or objects, or conditions that prevent light being reflected back
- Horizontal lines or intricate patterns
- Fast moving objects
- When there is an object in the foreground and an object in the background in the same picture
- Strongly reflected light or strong backlighting (bright background)

Instant Review

The image appears on the LCD monitor for one second (Instant Review) immediately after it is captured. You can change the Instant Review time. (p.82)

You can delete the image during Instant Review by pressing the  button.

Playing Back Still Pictures

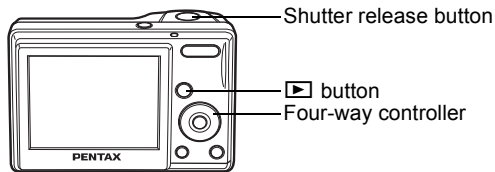

2

Quick Start

Playing Back Images

- 1 Press the **▶** button after taking a picture.

The image appears on the LCD monitor. In this manual, this is called **▶** mode (Playback mode). Displaying one image in full in **▶** mode (**▶** mode default setting) is called single-image display.

Press the **▶** button again in **▶** mode or press the shutter release button halfway to switch to **Ⓢ** mode.



Playing Back the Previous or Next Image

- 1 Press the **▶** button after taking a picture.

The image appears on the LCD monitor.

- 2 Press the four-way controller (**◀▶**).

The previous or next image appears.

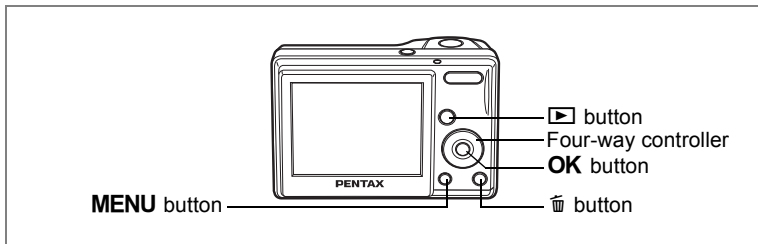

Rotating the Displayed Image

- 1 Press the button after taking a picture.

The image appears on the LCD monitor.

- 2 Press the four-way controller ().

The Playback Mode Palette appears.

- 3 Use the four-way controller (, , ,) to select (Image Rotation).

- 4 Press the OK button.

The image is rotated 90 degrees clockwise each time the button is pressed.

- 5 Press the MENU button twice.

The rotated image appears.

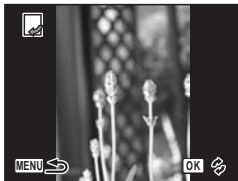

- Movies cannot be rotated.
- Protected images can be rotated, but they cannot be saved in a rotated state.

Deleting the Displayed Image







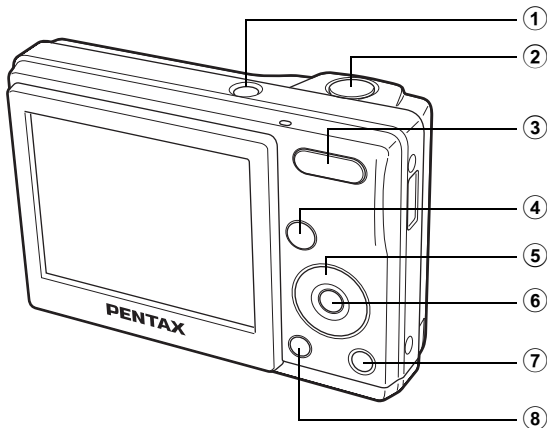

Press the button while the image is displayed to display the Delete screen. Use the four-way controller () to select [Deletion] and press the OK button. (p.103)



Understanding the Button Functions



Mode

- ① **Power switch**
Turns the camera off. (p.32)
- ② **Shutter release button**
Focuses the camera on the subject when pressed halfway in Still Picture Capture Mode. (Except in  and **MF** modes) (p.38)
Takes the still picture when pressed down fully. (p.38)
Starts and stops movie recording in  mode. (p.88)
Starts and stops sound file recording in  mode. (p.124)
- ③ **Zoom//// button**
Changes the captured area. (p.66)
- ④ ** button**
Switches to the  mode. (p.93)

⑤ **Four-way controller**

(▲) : Changes the drive mode. (p.62, p.63, p.64)

(▼) : Displays the Capture Mode Palette. (p.51)

(◀) : Changes the flash mode. (p.73)

(▶) : Changes the focus mode. (p.71)

(▲▼) : Adjusts **MF** in **MF** mode. (p.72)

⑥ **OK/DISPLAY button**

Changes the information displayed on the LCD monitor. (p.69)

⑦ **Green button**

Switches to the Green Mode. (p.58)







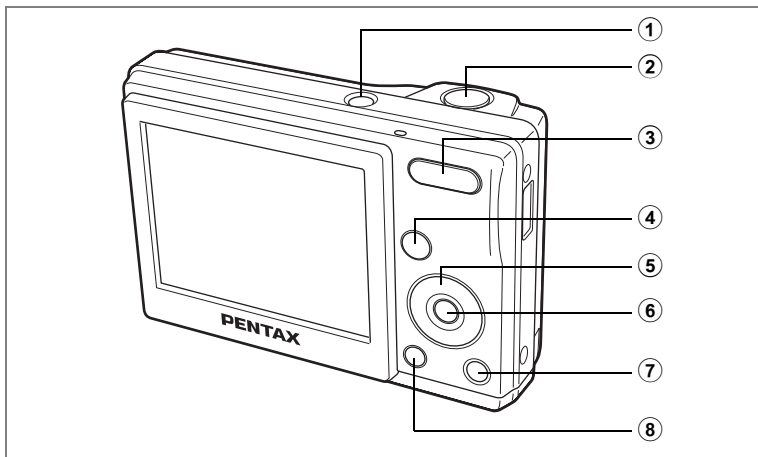



Displays an explanation of the function selected on the Capture Mode Palette. (p.56)

⑧ **MENU button**

Displays the [ Rec. Mode] menu. (p.46)



▶ Mode

- ① **Power switch**
Turns the camera off. (p.32)
- ② **Shutter release button**
Switches to  mode when pressed halfway. (p.93)
- ③ **Zoom// button**
Switches from single-image display to nine-image display when  is pressed and to folder display when  is pressed again. Returns to the previous display when  is pressed. (p.94)
Enlarges the image when  is pressed during single-image display. Returns to the previous display when  is pressed. (p.96)
Can be used to adjust the volume during movie playback. (p.101, p.126)
- ④ ** button**
Switches to  mode. (p.93)

⑤ Four-way controller

- (▲) : Plays back and pauses a movie or sound file. (p.101, p.126)
- (▼) : Displays the Playback Mode Palette. (p.56)
Stops a movie or sound file during playback. (p.101, p.126)
- (◀▶) : Displays the previous or next image and sound file during single-image display. (p.40)
Frame forwards, frame reverses and reverses a movie during playback. (p.101)
Fast forwards, reverses, and moves to the index in sound file playback. (p.126)
- (▲▼◀▶) : Moves the display area during zoom display. (p.96)
Selects an image in nine-image display and a folder in folder display. (p.94)

⑥ OK/DISPLAY button

- Changes the information displayed on the LCD monitor. (p.98)
- Returns zoom display or nine-image display to single-image display. (p.94, p.96)
- Changes to nine-image display of the selected folder during folder display. (p.95)

⑦ Green/🗑️ button

- Switches from single-image display to the Delete screen. (p.103)
- Switches from nine-image display to the Select & Delete screen. (p.105)
- Displays a guide of the function selected on the Playback Mode Palette. (p.56)

⑧ MENU button

- Displays the [X↓ Setting] menu during single-image display. (p.46)
- Returns to single-image display during Playback Mode Palette display. (p.55)
- Returns zoom display or nine-image display to single-image display. (p.94, p.96)
- Changes to nine-image display of the selected folder during folder display. (p.95)

Setting the Camera Functions

To change the camera settings, press the **MENU** button to display the [📷 Rec. Mode] menu or [⏏ Setting] menu. Menus for playing back and editing images and sound files are displayed from the Playback Mode Palette.

Setting with the Menus

Pressing the **MENU** button in 📷 mode displays the [📷 Rec. Mode] menu. Pressing the **MENU** button in ▶ mode displays the [⏏ Setting] menu.

During recording

During playback

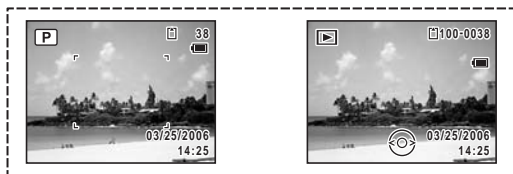

MENU

MENU

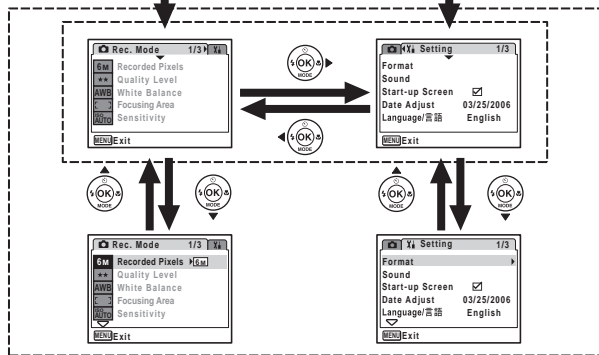

SHUTTER

MENU, OK or ▶

Press halfway



The setting is complete and the camera returns to 📷 mode



The setting is complete and the camera returns to ▶ mode



A guide to available button operations appears on the LCD monitor during menu operation.

Ex.) To set the [Quality Level] on the [Rec. Mode] menu

1 Press the MENU button in camera mode.

The [Rec. Mode] menu appears.

2 Press the four-way controller (▼).

The frame moves to [Recorded Pixels].

3 Press the four-way controller (▼).

The frame moves to [Quality Level].

4 Press the four-way controller (▶).

A pull-down menu appears with the items that can be selected.

The pull-down menu displays only those items that can be selected with the current camera settings.

5 Use the four-way controller (▲▼) to change the setting.

The quality level changes each time the four-way controller (▲▼) is pressed.

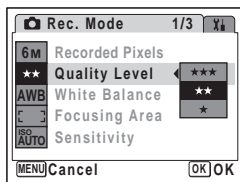
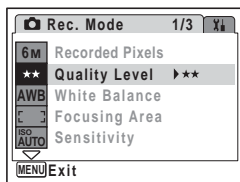
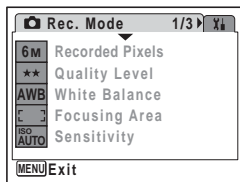

Refer to the following page for instructions on saving settings and canceling changes.

To Save the Setting and Start Taking Pictures

6 Press the shutter release button halfway.

The setting is saved and the camera returns to capture status.
When the shutter release button is pressed fully, the picture is taken.

To Save the Setting and Begin Playback of Images

6 Press the button.

The setting is saved and the camera returns to playback status.

To Save the Setting and Continue with Menu Operations

6 Press the OK button or the four-way controller (◀).

The setting is saved and the screen returns to Step 3.

To Cancel the Changes and Continue with Menu Operations

6 Press the MENU button.

The changes are canceled and the screen returns to Step 3.

The **MENU** button function differs depending on the screen. Refer to the guide indications.

 Exit : Exits the menu and returns to the original screen.

  : Returns to Step 3 with the current setting.

 Cancel : Cancels the current selection, exits the menu and returns to Step 3.

Menu List

This displays the items that can be set with the menus and provides descriptions of each item. See the list of default settings in the Appendix “Default Settings” (p.142) to decide whether you want the settings saved when the camera is turned off and whether you want the settings returned to the defaults when the camera is reset.

Rec. Mode] Menu



This menu shows the functions related to taking still pictures and recording movies.

Item	Description	Page	
Recorded Pixels	For choosing the number of recorded pixels of still pictures	p.75	
Quality Level	For choosing the quality level of still pictures	p.77	
White Balance	For adjusting the color balance according to the light conditions	p.78	
Focusing Area	For changing the area of the autofocus	p.80	
Sensitivity	For setting the sensitivity	p.81	
EV Compensation	For adjusting the overall brightness of the picture	p.68	
Movie	Recorded Pixels	For choosing the number of recorded pixels of movies	p.90
	Frame Rate	For setting the frame rate (number of frames per second)	p.92
	Color Mode	For choosing a color mode for movies	p.91
Digital Zoom	For choosing whether to use the digital zoom function	p.67	
Instant Review	For setting the Instant Review time	p.82	
Memory	For choosing whether to save the set values of the shooting function or return to the defaults when the camera is turned off	p.86	
Sharpness	For choosing sharp or soft outlines	p.83	
Saturation	For setting the color saturation	p.84	
Contrast	For setting the image contrast level	p.85	



Use the Green Mode to enjoy easy picture-taking using standard settings, regardless of the settings in the  Rec. Mode] menu. (p.58)

[X] Setting] Menu

Item	Description	Page
Format	For formatting the SD Memory Card or built-in memory	p.129
Sound	For adjusting the playback volume and setting the start-up sound, shutter sound, key operation sound and self-timer sound	p.130
Start-up Screen	For setting the start-up screen	p.132
Date Adjust	For adjusting the date, time, and date and time styles	p.133
Language/言語	For setting the language in which menus and messages appear	p.135
Folder Name	For choosing how names are assigned to folders for storing images and sound files	p.136
USB Connection	For setting the USB cable connection (to PC or printer)	p.137
Video Out	For setting the output format to the AV equipment	p.138
Auto LCD Dimmer	For automatically adjusting the brightness of the LCD monitor according to the surrounding brightness	p.139
Auto Power Off	For setting the time until the camera turns off automatically	p.140
Quick Zoom	For displaying an image at maximum magnification by pressing  on the Zoom/  /Quick Zoom button during still picture playback	p.97
Reset	For returning settings other than the date and time, language, and video out to their defaults	p.141

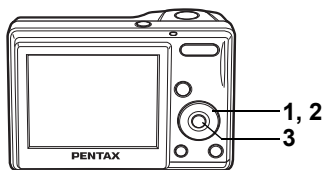

Setting the Shooting Mode

The Optio M10 has a variety of shooting modes that let you take pictures or record movies and sound in different situations simply by choosing the right mode for the particular situation from the Capture Mode Palette.

1 Press the four-way controller (▼) in mode.

The Capture Mode Palette appears.

2 Use the four-way controller (▲▼◀▶) to choose a shooting mode.

Choose a shooting mode and press the Green button to display a guide of the shooting mode. (p.56)



3 Press the OK button.

The shooting mode is selected and the camera returns to capture status.



- In shooting modes other than , and , the flash, focus, saturation, contrast, sharpness, white balance, etc. are automatically set to the optimal settings for each mode.
- Some functions may not be available or may not function fully depending on the shooting mode. For details, refer to “Functions Available for Each Shooting Mode” (p.145).
- The Capture Mode Palette does not appear even if you press the four-way controller (▼) when Focus Mode is set to **MF**.

There are 15 available shooting modes.

① **P Program**

The basic picture-taking mode. You can let the camera set the functions or choose various functions yourself. (p.57)

② **Night Scene**

Ideal for taking night views. It is best to use a tripod in this mode. Use the flash if including people in your picture. (p.60)



③ **Movie**

Use this mode for taking movies. Sound is recorded at the same time. (p.88)

④ **Voice Recording**

Use this mode to record sound files. Be careful not to cover the microphone below the lens on the camera with your hand. (p.124)

⑤ **SOFT Soft**

For taking pictures with soft, blurred outlines.



⑥ **Landscape**

Use this mode for taking landscape views. The depth of field encompasses a wide area.



⑦ **Flower**

Use this mode for taking bright, colorful pictures of flowers with soft outlines.



8  **Portrait**

Use this mode for taking pictures of people. Gives your subject a bright, healthy look.

**9**  **Surf & Snow**

For capturing images with dazzling backgrounds, such as beaches or snowy mountains.

**10**  **Sport**

Ideal for taking fast-moving action shots. The camera keeps the moving subject in focus until the shutter release button is pressed.

**11**  **Kids**

Ideal for taking pictures of children who are moving around. Gives your subject a bright, healthy look.

**12**  **Pet**

Ideal for taking pictures of pets. The camera keeps the moving pet in focus until the shutter release button is pressed. You can select settings according to the color of your pet's coat. (p.61)

**13**  **Fireworks**

Use this mode to take spectacular pictures of fireworks. It is best to use a tripod as the shutter speed is fixed at 4 sec. (p.60)



14  **Food**

Use this mode for taking pictures of food. The increased saturation gives pictures a bright, vivid finish.

**15**  **Self-portrait**

Use this mode to take pictures of yourself or include yourself in pictures. The camera adjusts the focus and color.









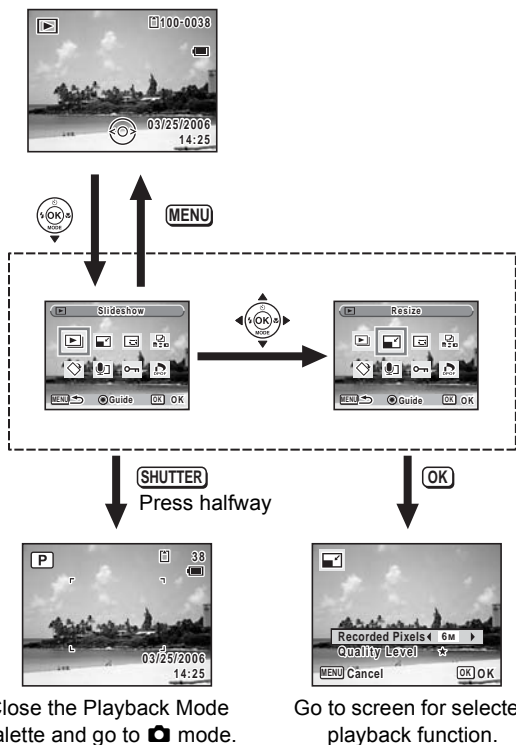

Setting the Playback Mode

Press the four-way controller (▼) in Playback mode to display the Playback Mode Palette.

You can display the playback function you want to use simply by using the four-way controller (▲▼◀▶) to choose an icon and pressing the **OK** button.



Playback Mode Palette

Item	Description	Page	
	Slideshow	For playing back recorded images one after another	p.99
	Resize	For changing the recorded pixels and quality of images	p.110
	Trimming	For deleting the unneeded part of a picture	p.112
	Image/ Sound Copy	For copying images and sound files from the built-in memory to the SD Memory Card and vice versa	p.113
	Image Rotation	For rotating still pictures	p.41
	Voice Memo	For adding a voice memo to still pictures	p.127
	Protect	For protecting images and sound files from accidental deletion	p.108
	DPOF	For setting the DPOF print order data for still pictures	p.115

Viewing a Guide of the Shooting and Playback Modes

Selecting a mode on the Capture Mode Palette or Playback Mode Palette and pressing the Green button displays an explanation of the selected item.

1 Press the four-way controller (▼) in mode.

The Capture Mode Palette appears.

Press the four-way controller (▼) in  mode to display the Playback Mode Palette.

2 Use the four-way controller (▲▼◀▶) to choose a shooting mode.



3 Press the Green button.

A guide of the selected shooting mode appears.

4 Press the OK button.

The camera returns to capture status with the selected shooting mode.

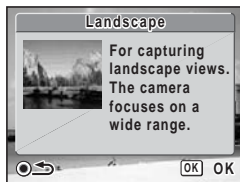

Press the Green button while the guide is displayed to return to the Capture Mode Palette or Playback Mode Palette.

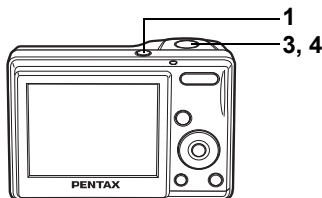

P

Letting the Camera Choose the Optimal Settings (Program Mode)

In **P** (Program mode), the camera automatically sets the shutter speed and aperture for taking still pictures. However, you can select other functions such as the flash mode and recorded pixels.

- 1 Press the power switch.**
- 2 Set the functions you want to use.**
- 3 Press the shutter release button halfway.**

The focus frame on the LCD monitor turns green if the subject is in focus.

- 4 Press the shutter release button fully.**

The picture is taken.



If a shooting mode other than **P** mode has been selected, select **P** mode from the Capture Mode Palette. (p.51)

Taking Still Pictures p.38

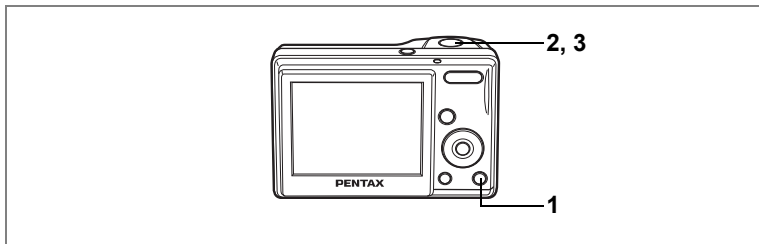

Taking Pictures in the Basic Mode (Green Mode)

In the Green Mode, you can enjoy easy picture-taking using standard settings*, regardless of the settings in the [📷 Rec. Mode] menu.

4

1 Press the Green button in 📷 mode.

The camera switches to the Green Mode. Press the Green button again to return to the status before the Green Mode was selected.

2 Press the shutter release button halfway.

The focus frame on the LCD monitor turns green if the subject is in focus.



Key lock icon







3 Press the shutter release button fully.

The picture is taken.



- In Green Mode, you cannot change the information displayed on the LCD monitor by pressing the **OK/DISPLAY** button.
- You cannot use the [📷 Rec. Mode] menu or Capture Mode Palette in Green Mode. If you try to display the [📷 Rec. Mode] menu or Capture Mode Palette, 🔒 (key lock icon) appears.
- If you switched to ▶ mode from Green Mode, you cannot display the [X↓ Setting] menu by pressing the **MENU** button. If you try to display the [X↓ Setting] menu, 🔒 (key lock icon) appears.
- When the camera is turned off in the Green Mode, it turns on in the Green Mode next time the power switch is pressed.

* The Green Mode settings are as shown below.

Flash Mode	 (Auto)
Drive Mode	<input type="checkbox"/> (Standard)
Focus Mode	AF (Standard)
Information Display	Standard
Recorded Pixels	 ( for Frame Composite function)
Quality Level	★★ (Better)
White Balance	AWB (Auto)
Focusing Area	 (Multiple)
Sensitivity	Auto
EV Compensation	±0.0
Digital Zoom	<input checked="" type="checkbox"/> (On)
Instant Review	1 sec
Sharpness	 (Standard)
Saturation	 (Standard)
Contrast	 (Standard)

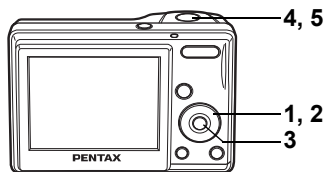

Taking Pictures of Dark Scenes (Night Scene/Fireworks Mode)

4

Taking Pictures

You can choose settings appropriate for taking pictures of dark scenes, such as nightscapes.

	Use this mode when taking pictures of night views.
	Use this mode to take spectacular pictures of fireworks.

1 Press the four-way controller (▼) in mode.

The Capture Mode Palette appears.

2 Use the four-way controller (▲▼◀▶) to select (Night Scene) or (Fireworks).

3 Press the OK button.

The shooting mode is selected and the camera returns to capture status.

4 Press the shutter release button halfway.

The focus frame on the LCD monitor turns green if the subject is in focus.

5 Press the shutter release button fully.

The picture is taken.



- The shutter speed is slower when taking pictures of dark scenes.
- To prevent camera shake, use a tripod and the self-timer function. (p.62)
- The sensitivity is set at 64, the focus mode is set to ▲, and the flash mode is set to in mode. In addition, the shutter speed is set at 4 sec. and the aperture is left open, and EV compensation is not available.

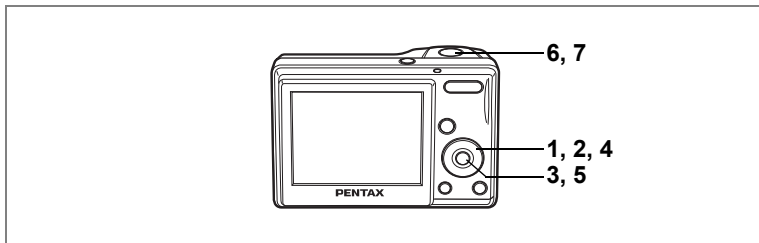

Taking Pictures of Your Pet (Pet Mode)

Use this mode to keep your moving pet in focus while you take the picture and capture the color of your pet's coat. Choose the appropriate icon depending on what color your pet is (closer to black or white or in between).

- 1 Press the four-way controller (▼) in mode.**
The Capture Mode Palette appears.
- 2 Use the four-way controller (▲▼◀▶) to select (Pet).**
- 3 Press the OK button.**
The Pet mode selection screen appears.
- 4 Use the four-way controller (▲▼) to select , , , , or .**
There are two types of icons: a cat and dog icon.
(Choosing either the cat or dog icon does not affect the resulting picture. Choose whichever you prefer.)
- 5 Press the OK button.**
The Pet mode is selected and the camera returns to capture status.
- 6 Press the shutter release button halfway.**
The focus frame on the LCD monitor turns green if the subject is in focus.
- 7 Press the shutter release button fully.**
The picture is taken.



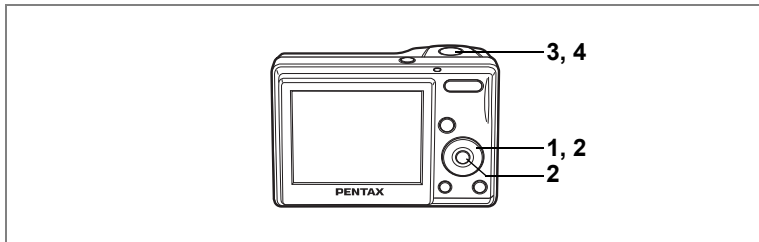

Using the Self-timer

In Self-timer mode, the picture is taken ten seconds or two seconds after the shutter release button is pressed.

Stabilize the camera with a tripod when taking a picture with the self-timer.

	Use this mode when you want to be included in a group picture. The picture is taken approximately ten seconds after the shutter release button is pressed.
	Use this mode to avoid camera shake. The picture is taken approximately two seconds after the shutter release button is pressed.

1 Press the four-way controller (▲) in mode.

2 Use the four-way controller (◀▶▼) to select or and press the OK button.

The camera is ready to take the picture using the self-timer.

3 Press the shutter release button halfway.



The focus frame on the LCD monitor turns green if the subject is in focus.

4 Press the shutter release button fully.

The picture is taken ten seconds or two seconds later.



Focusing may be compromised if you move the camera while the self-timer lamp is blinking when taking still pictures.



- In mode, recording will start after ten seconds (or two seconds).
- Press the shutter release button halfway while the self-timer is engaged to stop the countdown and press fully to restart the countdown.
- cannot be selected while is in default setting. Select in another shooting mode and then switch the shooting mode to .

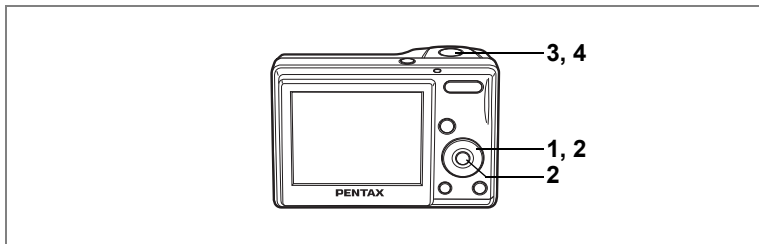

Taking a Series of Pictures

In this mode, pictures are taken continuously for as long as the shutter release button is pressed.

	Continuous Shooting	Each time a picture is taken, the image is saved in the memory before the next image is taken. The higher the image quality, the longer the interval between shots.
--	---------------------	---

1 Press the four-way controller (▲) in mode.

2 Use the four-way controller (◀▶) to select (Continuous Shooting) and press the OK button.

The camera is ready to take a series of pictures.

3 Press the shutter release button halfway.

The focus frame on the LCD monitor turns green if the subject is in focus.

4 Press the shutter release button fully.

Pictures are taken continuously for as long as you keep the shutter release button pressed.



- The flash will not discharge in Continuous Shooting mode.
- The continuous shooting function is not available in , , , , **SOFT** or mode.



- You can continue shooting until the memory capacity of the SD Memory Card or built-in memory is full.
- The interval of continuous shooting will vary according to the Recorded Pixels and Quality Level settings.
- The focus, exposure and white balance are locked with the first image.

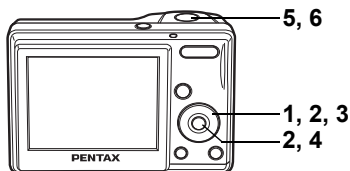

Framing Your Pictures

In this mode you can take pictures using the frames stored in the camera. There are three frames already stored in the camera.

4

Taking Pictures

- 1 Press the four-way controller (\blacktriangle) in CAM mode.**

The drive mode selection screen appears.

- 2 Use the four-way controller ($\blacktriangle\blacktriangleright$) to select FR (Frame Composite) and press the OK button.**



The frame selection screen appears.

- 3 Use the four-way controller ($\blacktriangle\blacktriangleright$) to choose the frame you want to use.**

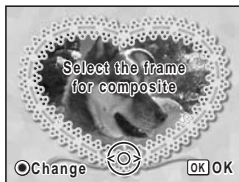

- 4 Press the OK button.**

The frame appears on the screen.

- 5 Press the shutter release button halfway.**

The focus frame on the LCD monitor turns green if the subject is in focus.



6 Press the shutter release button fully.

The picture is taken.



- The frame function is not available in or mode.
- Press the **MENU** button in the frame selection screen to display the [Rec. Mode] menu.
- The number of recorded pixels is fixed at **3M** and the quality level at **★★**.

To Register a New Frame

To switch to the screen for registering a frame, press the Green button in Step 3. You can register frames which you have downloaded from the internet, etc. When you register a new frame, it replaces one of the existing three frames in the built-in memory. Before you register a new frame, copy it first to the SD Memory Card.



When a new frame on the SD Memory Card is registered in the built-in memory, it replaces one of the existing frames in the built-in memory. The replaced frame is deleted from the built-in memory.

1 In the frame selection screen, choose the frame you want to replace and press the Green button.

A message appears and the frames on the SD Memory Card that you can register in the built-in memory appear.

2 Use the four-way controller (◀▶) to choose the frame you want to register and press the OK button.

The frame is registered in the built-in memory instead of the frame selected in Step 1.

Visit the PENTAX website at the URL below to download new frames.

http://www.pentax.co.jp/english/support/digital/optio_frame.html

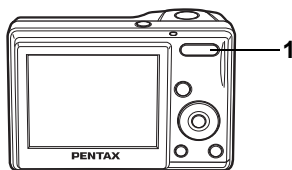

Using the Zoom

You can use the zoom to change the captured area.

4

1 Press the Zoom/🌳/🌳/🌳 button in mode.

🌳 Tele : enlarges the subject

🌳🌳 Wide : widens the area that is captured by the camera

The zoom bar indicates the current level of magnification.



Zoom bar

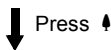

When the digital zoom function is set to (Off), you can take pictures at up to three times magnification using the optical zoom. When the digital zoom function is set to (On), you can combine it with the optical zoom to enlarge the subject to a maximum magnification equivalent to 12 times.

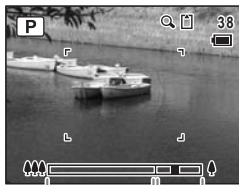

Optical zoom range Digital zoom range



- You are recommended to use a tripod to prevent camera shake when taking pictures at a high magnification rate.
- Pictures taken in the digital zoom range appear grainier than pictures taken in the optical zoom range.

Setting the Digital Zoom

The digital zoom is set to (On) in the default settings. To take pictures using only the optical zoom, set the digital zoom to (Off).

1 Press the MENU button in  mode.

The [ Rec. Mode] menu appears.

2 Use the four-way controller (▲▼) to select [Digital Zoom].

3 Use the four-way controller (◀▶) to select (On) or (Off).

The selected setting is saved.

4 Press the MENU button.

The setting is complete and the camera returns to capture status.

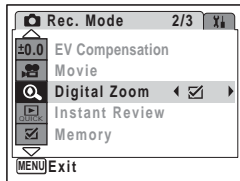

Saving the Digital Zoom Function Setting  p.86



Setting the Exposure (EV Compensation)

You can adjust the overall brightness of the picture.

Use this function to take pictures that are intentionally overexposed or underexposed.

1 Press the MENU button in mode.

The [ Rec. Mode] menu appears.

2 Use the four-way controller () to select [EV Compensation].

3 Use the four-way controller () to select the EV value.

The selected EV value is saved.

To brighten, select a positive (+) value. To darken, select a negative (-) value.

You can choose the EV setting in the range of -2.0 EV to +2.0 EV in 1/3 EV steps.

4 Press the MENU button.

The setting is complete and the camera returns to capture status.

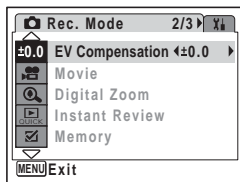

When the histogram is displayed, bright portions and dark portions are indicated on the LCD monitor, enabling you to check the exposure. (p.70)

Saving the EV Compensation Value  p.86

Displaying Shooting Information in Capture Mode

The LCD monitor display changes in the following sequence each time you press the **OK/DISPLAY** button: Normal Display, Histogram + Info, No Icons.

For details of each display mode, refer to “Monitor Indications” (p.16).



appears when camera shake is likely to occur. To prevent camera shake, use a tripod and the self-timer function. (p.62)

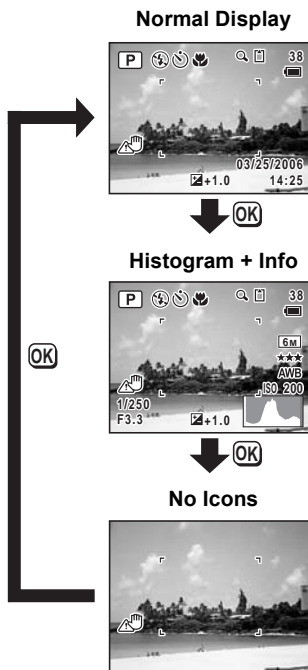

Using the Histogram

A histogram shows the brightness distribution of an image. The horizontal axis represents brightness (dark at the left and bright at the right) and the vertical axis represents the number of pixels.

The shape of the histogram before and after shooting tells you whether the brightness and contrast are correct or not, and lets you decide if you need to use EV compensation and take the picture again.

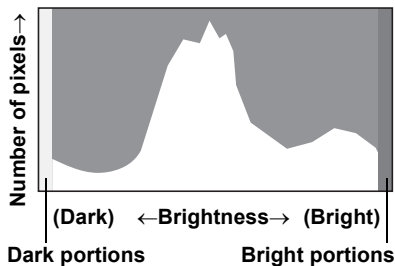

Setting the Exposure (EV Compensation)  p.68

Understanding Brightness

If the brightness is correct, the graph peaks in the middle. If the image is too dark, the peak is on the left side, and if it is too bright, the peak is on the right side.

Dark image



Correct image

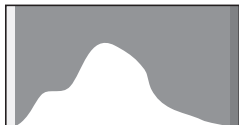

Bright image

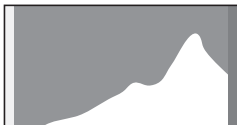

When the image is too dark, the part to the left is cut off (dark portions) and when the image is too bright, the part to the right is cut off (bright portions).

Bright portions blink red on the LCD monitor and dark portions blink yellow.

Displaying Shooting Information in Capture Mode  p.69

Displaying Shooting Information in Playback Mode  p.98

Understanding Contrast

The graph peaks gradually for images in which contrast is balanced. The graph peaks on both sides but sinks in the middle for images with a large difference in contrast and low amounts of mid-level brightness.

Setting the Shooting Functions

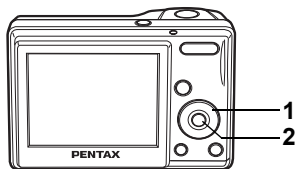

Selecting the Focus Mode

Focus Mode

AF	Standard	Use this mode when the distance to the subject is 40 cm (15.7 in.) or more. The camera is focused on the subject in the autofocus area when the shutter release button is pressed halfway.
	Macro	This mode is used when the distance to the subject is approx. 10 cm to 60 cm (3.9 in. to 23.6 in.). The camera is focused on the subject in the autofocus area when the shutter release button is pressed halfway.
	Infinity	This mode is used for taking distant objects. The flash is set to (Flash Off).
MF	Manual Focus	This mode lets you adjust the focus manually.

1 Press the four-way controller (▶) in mode.

The focus mode changes each time the button is pressed. You can also change the setting using the four-way controller (▲▼).

2 Press the OK button.

The Focus Mode setting is saved and the camera returns to capture status.

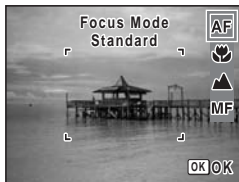

- In mode, the focus mode is set to ▲.
- In mode, you can only select **AF** and .

Manual Focus p.72

Saving the Focus Mode p.86

Manual Focus

The procedure for setting the focus manually (**MF**) is described below.

- 1 Press the four-way controller (▶) in  mode.**
- 2 Use the four-way controller (▶) to select MF and press the OK button.**

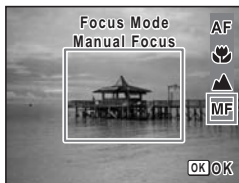

The central portion of the image is magnified to fill the screen of the LCD monitor when focusing.

- 3 Press the four-way controller (▲▼).**

The **MF** indicator appears on the LCD monitor to indicate the approximate distance to the subject. Use the four-way controller (▲▼) to adjust the focus using the indicator as a guide.

▲ : for distant focus

▼ : for closer focus

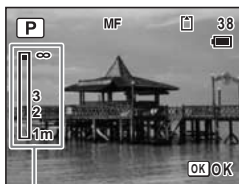

MF indicator

- 4 Press the OK button.**

The focus is fixed and the camera returns to capture status.

The focus position is fixed five seconds after you remove your finger from the four-way controller.

After the focus is fixed, you can press the four-way controller (▲▼) again to display the **MF** indicator and readjust the focus.



Shooting mode and drive mode cannot be changed while adjusting **MF**.

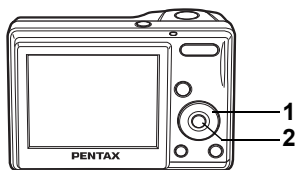

Selecting the Flash Mode

Flash Modes

	Auto	The flash discharges automatically depending on the light conditions.
	Flash Off	The flash will not discharge, regardless of the brightness. Use this mode to take pictures where flash photography is prohibited.
	Flash On	The flash discharges regardless of the brightness.
	Auto + Red-eye	This mode reduces the phenomenon of red eyes caused by the light from the flash being reflected in the subject's eyes. The flash discharges automatically.
	Flash On + Red-eye	This mode reduces the phenomenon of red eyes caused by the light from the flash being reflected in the subject's eyes. The flash will discharge regardless of the light conditions.



- The flash will not discharge (Flash Off) in mode or mode, or when the drive mode is set to , or the focus mode is set to .
- A pre-flash discharges when using the red-eye reduction function.
- In mode, you can only select or .

1 Press the four-way controller (◀) in mode.



The flash mode changes each time the button is pressed. You can also change the setting using the four-way controller (▲▼).

2 Press the OK button.

The camera returns to capture status with the selected flash mode.



[About the red-eye phenomenon]

Taking pictures using the flash may cause the subject's eyes to appear red in the resulting picture. This phenomenon occurs when the light from the flash is reflected in the subject's eyes. It can be reduced by illuminating the area around the subject or moving closer to the subject and zooming out to a wider angle. Setting the flash mode to  (Auto + Red-eye) or  (Flash On + Red-eye) is also an effective way of reducing red eyes.

Saving the Flash Mode  p.86



Selecting the Recorded Pixels

You can choose from seven recorded pixels settings for still pictures. The larger your recorded pixels, the clearer the details will appear when you print your picture. As the quality of the printed picture also depends on the image quality, exposure control, resolution of the printer and other factors, you do not need to select more than the required number of recorded pixels. **2M** (1600×1200) is adequate for making postcard-size prints. The more pixels there are, the larger the picture and the bigger the file size. The data volume also varies depending on the quality level setting (p.77).

Recorded Pixels

Recorded Pixels	Use
6M 2816×2112	For printing high quality photos or A4-size pictures, or editing images on a PC.
5M 2560×1920	
4M 2304×1728	For making postcard-size prints.
3M 2048×1536	
2M 1600×1200	
1024 1024× 768	For posting on a website or attaching to e-mail.
640 640× 480	

1 Press the **MENU** button in **Rec. Mode**.

The [Rec. Mode] menu appears.

2 Use the four-way controller (▲▼) to select [Recorded Pixels].

3 Press the four-way controller (▶).

A pull-down menu appears.

4 Use the four-way controller (▲▼) to change the number of recorded pixels.

5 Press the OK button.

The Recorded Pixels setting is saved.

6 Press the MENU button.

The camera returns to capture status with the current setting.

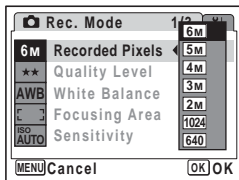

When drive mode is set to , the number of recorded pixels is set to **3M** and quality level is set to **★★**.



Selecting the Quality Level

You can select the quality (compression rate) of still pictures. The more stars, the lower the compression rate and the clearer the picture, but the file size becomes larger. The recorded pixels setting also affects the file size (p.75).

Quality Level

★★★	Best	Lowest compression rate. Suitable for photo prints.
★★	Better	Standard compression rate. Suitable for viewing the image on a computer screen.
★	Good	Highest compression rate. Suitable for posting on a website or attaching to e-mail.

- 1 Press the MENU button in mode.**
The [Rec. Mode] menu appears.
- 2 Use the four-way controller (▲▼) to select [Quality Level].**
- 3 Press the four-way controller (▶).**
A pull-down menu appears.
- 4 Use the four-way controller (▲▼) to change the quality level.**
- 5 Press the OK button.**
The Quality Level setting is saved.
- 6 Press the MENU button.**
The camera returns to capture status with the current setting.

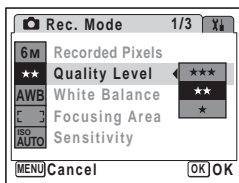

Quality level is set at ★★★ when drive mode is set to .

Recorded Pixels and Quality Level of Still Pictures p.29



Adjusting the White Balance

You can take pictures in natural colors by adjusting the white balance according to the light conditions at the time of shooting.

4

White Balance

AWB	Auto	The camera adjusts the white balance automatically.
	Daylight	Use this mode when taking pictures outside in sunlight.
	Cloudy	Use this mode when taking pictures outside on a cloudy day.
	Tungsten Light	Use this mode when taking pictures under electric or other tungsten light.
	Fluores. Light	Use this mode when taking pictures under fluorescent light.
	Manual	Use this mode when adjusting the white balance manually.

- 1 Press the MENU button in mode.**
The [Rec. Mode] menu appears.
- 2 Use the four-way controller () to select [White Balance].**
- 3 Press the four-way controller ().**
The White Balance screen appears.
- 4 Use the four-way controller () to change the setting.**
- 5 Press the OK button.**
The White Balance setting is saved.
- 6 Press the MENU button.**
The camera returns to capture status with the current setting.
Refer to “Manual Setting” (p.79) for instructions on adjusting the white balance manually.

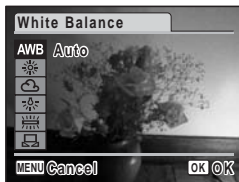

Saving the White Balance p.86

Manual Setting

Have a blank sheet of white paper or similar material ready.

- 1 In the White balance screen, use the four-way controller (▲▼) to select  (Manual).**
- 2 Point the camera at the blank sheet of paper or other material so that it fills the screen of the LCD monitor.**
- 3 Press the shutter release button fully.**

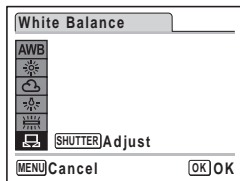

The white balance is automatically adjusted.

- 4 Press the OK button.**

The setting is saved and the screen returns to the [ Rec. Mode] menu.

- 5 Press the MENU button.**

The camera returns to capture status.

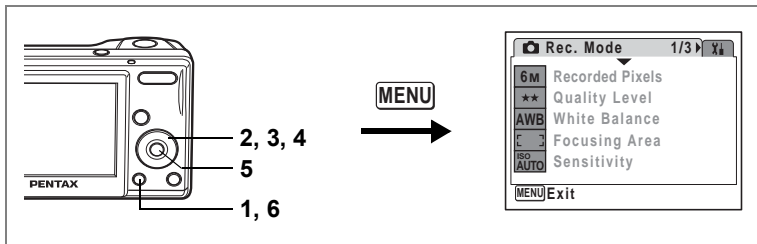

Changing the Focusing Area

You can change the autofocus area (Focusing Area).

4

Focusing Area

[]	Multiple	Normal range
[]	Spot	The autofocus range becomes smaller.
[]	Automatic Tracking AF	Keeps moving subjects in focus.

1 Press the **MENU** button in mode.

The [Rec. Mode] menu appears.

2 Use the four-way controller () to select [**Focusing Area**].

3 Press the four-way controller ().

A pull-down menu appears.

4 Use the four-way controller () to change the setting.

5 Press the **OK** button.

The Focusing Area setting is saved.

6 Press the **MENU** button.

The camera returns to capture status with the current setting.

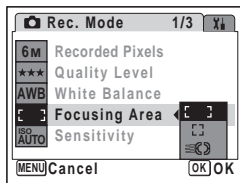

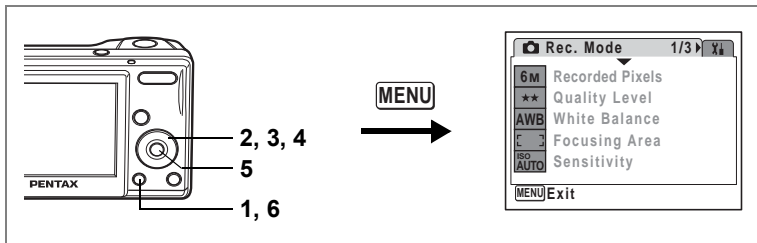

Setting the Sensitivity

You can select the sensitivity to suit the brightness of the surroundings.

Sensitivity

Auto	Sensitivity is automatically adjusted to between 64 and 200.
64	<ul style="list-style-type: none"> The lower the sensitivity, the less noise that affects the image. The shutter speed will be slower in low light conditions. Higher sensitivity settings use faster shutter speeds in low light conditions to reduce camera shake, but the image may be affected by noise.
100	
200	
400	

- 1 Press the MENU button in mode.**
 The [Rec. Mode] menu appears.
- 2 Use the four-way controller () to select [Sensitivity].**
- 3 Press the four-way controller ().**
 A pull-down menu appears.
- 4 Use the four-way controller () to change the sensitivity.**
- 5 Press the OK button.**
 The Sensitivity setting is saved.
- 6 Press the MENU button.**
 The camera returns to capture status with the current setting.

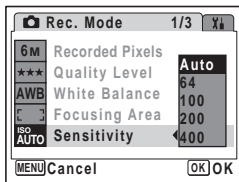

Sensitivity is set at 64 when Shooting mode is set to . Other values cannot be set.

Saving the Sensitivity p.86



Setting the Instant Review Time (Instant Review)

You can choose the Instant Review time (the length of time the image is displayed immediately after capture) from 0.5sec, 1sec, 2sec, 3sec, 5sec and Off (no display).

4

Taking Pictures

1 Press the **MENU** button in **☑** mode.

The [☑ Rec. Mode] menu appears.

2 Use the four-way controller (▲▼) to select [Instant Review].

3 Press the four-way controller (▶).

A pull-down menu appears.

4 Use the four-way controller (▲▼) to change the display time.

5 Press the **OK** button.

The Instant Review setting is saved.

6 Press the **MENU** button.

The camera returns to capture status with the current setting.

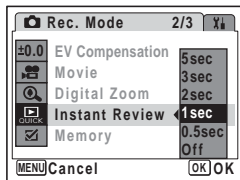

Instant Review p.39

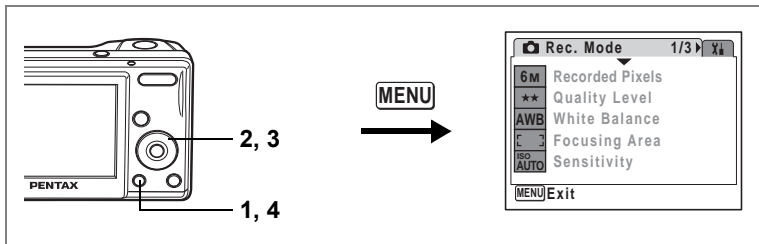

Setting the Image Sharpness (Sharpness)

You can give the image sharp or soft outlines.

- 1 Press the MENU button in mode.**
The [Rec. Mode] menu appears.
- 2 Use the four-way controller () to select [Sharpness].**
- 3 Use the four-way controller () to change the sharpness level.**

The following setting is saved.

- (Soft)
- (Normal)
- (Hard)

- 4 Press the MENU button.**

The Sharpness setting is saved and the camera returns to capture status.

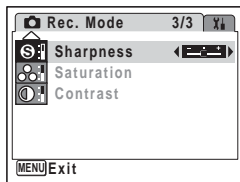

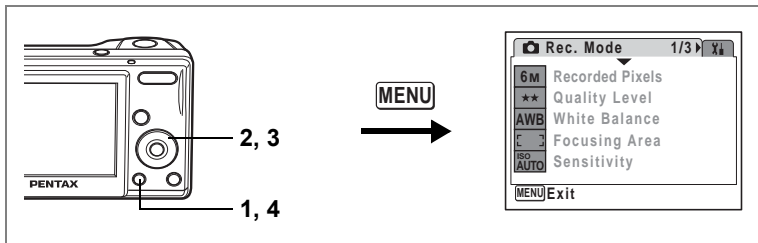

Setting the Color Saturation (Saturation)

You can set the color saturation.

4

1 Press the MENU button in mode.

The [Rec. Mode] menu appears.

2 Use the four-way controller () to select [Saturation].

3 Use the four-way controller () to change the saturation level.

The following setting is saved.

(Low)

(Normal)

(High)

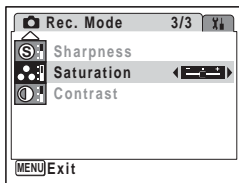

4 Press the MENU button.

The Saturation setting is saved and the camera returns to capture status.

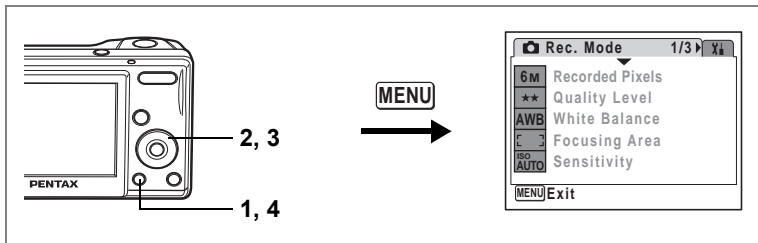

Setting the Image Contrast (Contrast)

You can set the image contrast level.

- 1 Press the MENU button in mode.**
The [Rec. Mode] menu appears.
- 2 Use the four-way controller () to select [Contrast].**
- 3 Use the four-way controller () to change the contrast level.**

The following setting is saved.

- (Low)
- (Normal)
- (High)

- 4 Press the MENU button.**

The Contrast setting is saved and the camera returns to capture status.

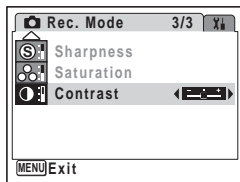

Saving the Settings (Memory)

The Memory function is for saving the current camera settings when the camera is turned off.

For some camera settings, the Memory function is always set to (On) (the settings are saved when the camera is turned off), while for others you can choose on or off (to choose whether the settings are saved or not when the camera is turned off). The items which can be set to (On) or (Off) in the Memory function are shown in the table below. (Items not listed here will be saved in the selected settings when the camera is turned off.) If you select (On), the settings will be saved in the status they were in immediately before the camera was turned off. If you select (Off), the settings will be reset to the defaults when the camera is turned off. The table below also shows whether the Memory default setting for each item is on or off.

Item	Description	Default Setting
Flash Mode	The flash mode set with the four-way controller (◀) (p.73)	<input checked="" type="checkbox"/>
Drive Mode	The drive mode set with the four-way controller (▲) (p.62, p.63, p.64)	<input type="checkbox"/>
Focus Mode	The focus mode set with the four-way controller (▶) (p.71)	<input type="checkbox"/>
Zoom Position	The zoom position set with the Zoom/⏏/⏏ button (p.66)	<input type="checkbox"/>
MF Position	The manual focus position set with the four-way controller (▲▼) (p.72)	<input type="checkbox"/>
White Balance	The [White Balance] setting on the [📷 Rec. Mode] menu (p.78)	<input type="checkbox"/>
Sensitivity	The [Sensitivity] setting on the [📷 Rec. Mode] menu (p.81)	<input type="checkbox"/>
EV Compensation	The [EV Compensation] setting on the [📷 Rec. Mode] menu (p.68)	<input type="checkbox"/>
Digital Zoom	The [Digital Zoom] setting on the [📷 Rec. Mode] menu (p.67)	<input checked="" type="checkbox"/>
DISPLAY	The LCD monitor information display mode set with the OK/DISPLAY button (p.69, p.98)	<input type="checkbox"/>
File #	If a new SD Memory Card is inserted when On has been selected, file numbers are assigned sequentially.	<input checked="" type="checkbox"/>

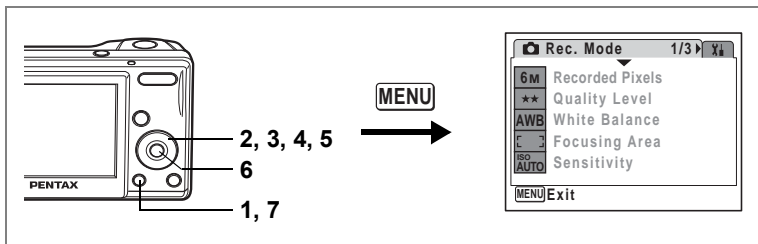

- 1 Press the MENU button in mode.**
The [Rec. Mode] menu appears.
- 2 Press the four-way controller () to select [Memory].**
- 3 Press the four-way controller ().**
The Memory screen appears.
- 4 Use the four-way controller () to choose an item.**
- 5 Use the four-way controller () to select (On) or (Off).**
- 6 Press the OK button.**
The Memory setting is saved.
- 7 Press the MENU button.**
The camera returns to capture status with the current setting.

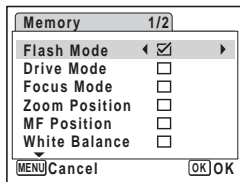

Recording Movies

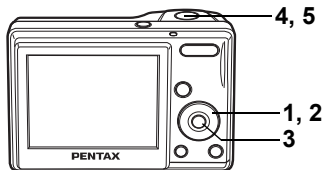

4

Recording a Movie

Taking Pictures

This mode enables you to record movies. Sound is recorded at the same time.

1 Press the four-way controller (▼) in mode.

The Capture Mode Palette appears.

2 Use the four-way controller (▲▼◀▶) to select (Movie).



3 Press the OK button.

 mode is selected and the camera returns to capture status.



The following information appears on the LCD monitor.

1 Movie mode icon

2 Recording indicator (blinks during recording)

3 Recording time



You can change the captured area by pressing the Zoom// button to the left or right.

 : enlarges the subject

 : widens the area that is captured by the camera

4 Press the shutter release button fully.

Recording starts.



- The flash will not discharge in mode.
- The focus is fixed when recording movies in mode.
- You can use the optical zoom and digital zoom before starting to record, and the digital zoom while recording.
- Changing the LCD monitor display mode by pressing the **OK/DISPLAY** button while recording a movie will not display the histogram.

5 Press the shutter release button fully.

Recording stops.

Playing Back Movies p.101

Keeping the Shutter Release Button Pressed

If you keep the shutter release button pressed for more than one second, recording will continue for as long as you keep the button pressed. Shooting stops when you take your finger off the shutter release button.



Selecting the Recorded Pixels for Movies

You can choose from two recorded pixels settings for movies:

[**320**] 320×240] and [**160**] 160×120].

The more pixels there are, the bigger the file size. The data volume also varies depending on the frame rate setting. (p.31)

Recorded Pixels for Movies

320 (320×240)	Suitable for viewing the movie on a computer.
160 (160×120)	The file size is smaller, but the total recording time is increased. Suitable for posting on a website or e-mail.

- 1 Press the MENU button in mode.**
The [Rec. Mode] menu appears.
- 2 Use the four-way controller (▲▼) to select [Movie].**
- 3 Press the four-way controller (▶).**
The Movie screen appears.
- 4 Use the four-way controller (▲▼) to select [Recorded Pixels].**
- 5 Press the four-way controller (▶).**
A pull-down menu appears.
- 6 Use the four-way controller (▲▼) to change the number of recorded pixels.**
- 7 Press the OK button.**
The Recorded Pixels setting is saved.
- 8 Press the MENU button twice.**
The camera returns to capture status with the current setting.

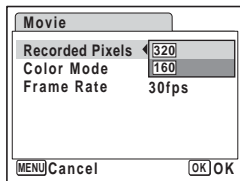

Recorded Pixels and Frame Rate of Movies p.31



Recording Movies in Black and White or Sepia Tones (Color Mode)

You can set the color mode to Black and White or Sepia, as well as Full Color, when recording a movie.

1 Press the **MENU** button in mode.

The [Rec. Mode] menu appears.

2 Use the four-way controller () to select [Movie].

3 Press the four-way controller ().

The Movie screen appears.

4 Use the four-way controller () to select [Color Mode].

5 Press the four-way controller ().

A pull-down menu appears.

6 Use the four-way controller () to choose a color.

7 Press the **OK** button.

The Color Mode setting is saved.

8 Press the **MENU** button twice.

The camera returns to capture status with the current setting.

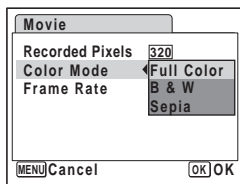

The color mode setting cannot be changed after a movie is recorded.



Selecting the Frame Rate

You can choose from two frame rates (number of frames per second) for movies: [30fps] and [15fps]. The more frames per second, the better the quality of the movie, but the file size becomes larger.

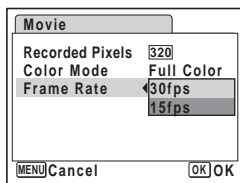

- 1 Press the MENU button in mode.**
The [Rec. Mode] menu appears.
- 2 Use the four-way controller () to select [Movie].**
- 3 Press the four-way controller ().**
The Movie screen appears.
- 4 Use the four-way controller () to select [Frame Rate].**
- 5 Press the four-way controller ().**
A pull-down menu appears.
- 6 Use the four-way controller () to select [30fps] or [15fps].**
- 7 Press the OK button.**
The Frame Rate setting is saved.
- 8 Press the MENU button twice.**
The camera returns to capture status with the current setting.



Recorded Pixels and Frame Rate of Movies p.31

Playing Back Images

To Switch Between Mode and Mode

In this manual, the capture mode, such as for taking still pictures, is referred to as “ mode”. The playback mode, such as for displaying captured images on the LCD monitor, is referred to as “ mode”. In  mode, you can perform simple editing operations on the images that are played back.

Follow the procedure below to switch between  mode and  mode.

To Switch from Mode to Mode

1 Press the button.

The camera switches to  mode.

To Switch from Mode to Mode

1 Press the button or shutter release button halfway.

The camera switches to  mode.

Playing Back Still Pictures

Refer to “Playing Back Images” (p.40) for instructions.

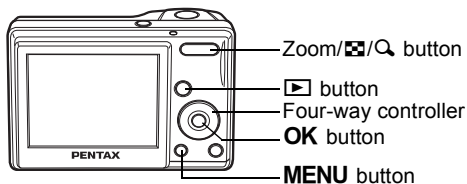

Nine-Image Display and Folder Display

Nine-Image Display

You can display nine thumbnails of captured images at a time.

1 In mode, press on the Zoom//Quick button.

A page consisting of nine thumbnail images appears. The displayed images change nine at a time page by page.

Use the four-way controller (, , ,) to move the frame. When 10 or more images have been saved, if you choose image ① and press the four-way controller (,), the previous page appears. Similarly, if you choose image ② and press the four-way controller (,), the next page appears.

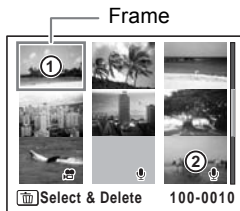

The icons that appear on the images indicate the following:

- No icon : Still picture without sound
- (with image) : Still picture with sound
- : Movie (first frame appears)
- (without image) : Sound file only

Press the **OK** button, **MENU** button or on the Zoom//Quick button to switch to single-image display of the selected image.

Press the button to switch to mode.

Folder Display





If images and sound files are stored in several folders, follow the procedure below to find the folder that you are looking for.



- 1 In  mode, press  on the Zoom//Q button.**



The screen changes to nine-image display.

- 2 Press  on the Zoom//Q button.**

The list of folders appears.

- 3 Use the four-way controller (   ) to choose a folder.**

Press the **OK** button, **MENU** button or  on the Zoom//Q button to display thumbnails of the images inside the folder.

Next, press the **OK** button, **MENU** button or  on the Zoom//Q button to switch to single-image display of a selected image.

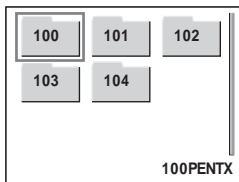

Changing the Image Folder Name  p.136

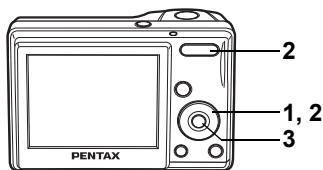

Zoom Playback

You can magnify an image up to eight times. A guide showing the center of the magnified portion of the image appears on the LCD monitor during zoom playback.

- 1 Enter the mode and use the four-way controller () to choose the image you want to magnify.
- 2 Press on the Zoom// button.

The image is magnified ($\times 1.1$ to $\times 8$). Holding down on the Zoom// button changes the magnification continuously. You can use the guide at the bottom left of the screen to check which portion of the image is magnified.



Guide

The following operations can be performed while the magnified image is displayed.

- | | |
|---------------------------|--|
| Four-way controller () | Moves the position to be magnified |
| Zoom// button () | Makes the image bigger (max. $\times 8$) |
| Zoom// button () | Makes the image smaller (min. $\times 1.1$) |

- 3 Press the **OK** button.

The image returns to single-image display.



- Movies cannot be magnified.
- The guide does not appear if the LCD monitor display mode is set to “No Icons”.

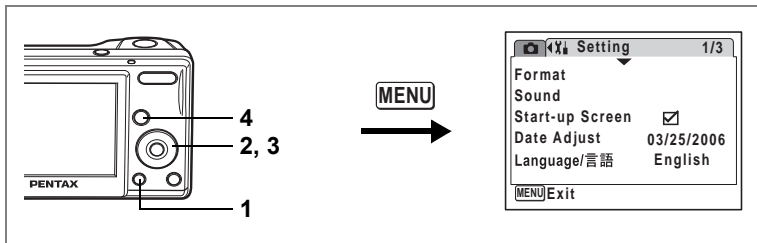

Setting the Quick Zoom Function

When the Quick Zoom function is enabled, you can display an image at maximum magnification ($\times 8$) simply by pressing on the Zoom// button once.

1 Press the MENU button in mode.

The [Setting] menu appears.

2 Use the four-way controller () to select [Quick Zoom].

3 Use the four-way controller () to select (On) or (Off).

- : Jumps to $\times 8$ magnification
- : Pressing on the Zoom// button once magnifies the image in stages from $\times 1.1$ to $\times 8.0$

4 Press the MENU button.

The camera returns to mode.

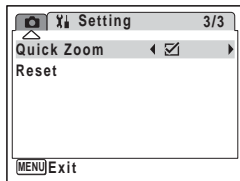

Displaying Shooting Information in Playback Mode

Shooting information can be displayed on the LCD monitor in  mode. Pressing the **OK/DISPLAY** button changes the display mode. Refer to p.18 for details of each display mode.

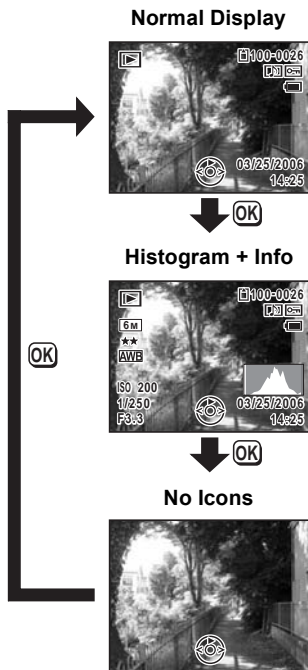









Displaying Shooting Information in Capture Mode  p.69







Slideshow

You can play back recorded images one after another.

- 1 Enter the  mode and use the four-way controller ( ) to choose an image to start the slideshow with.**
- 2 Press the four-way controller (.**
The Playback Mode Palette appears.
- 3 Use the four-way controller (   ) to select  (Slideshow).**
- 4 Press the OK button twice.**
The slideshow starts.
Pressing the **OK** button during the slideshow pauses the slideshow. To resume the slideshow, press the **OK** button while the slideshow is paused.
- 5 Press any button other than the OK button or the power switch.**
The slideshow stops.

Setting the Slideshow Conditions

You can set the playback interval and also a screen effect and sound effect for when one image changes to the next.

- 1 Press the four-way controller ( in  mode.**
The Playback Mode Palette appears.
- 2 Use the four-way controller (   ) to select  (Slideshow).**

3 Press the OK button.

The screen for setting the slideshow conditions appears.

4 Use the four-way controller (▲▼) to select [Interval].**5 Press the four-way controller (▶).**

A pull-down menu appears.

6 Use the four-way controller (▲▼) to change the interval and press the OK button.

You can choose from 3sec, 5sec, 10sec, 20sec, and 30sec.

7 Use the four-way controller (▲▼) to select [Screen Effect].

After selecting [Screen Effect], press the four-way controller (▶).

A pull-down menu appears with the following items that can be selected. Use the four-way controller (▲▼) to select an item and press the **OK** button.

Off	No effect
Wipe	The next image slides over the previous one from left to right
Checker	The next image appears in small square mosaic blocks
Fade	The current image gradually fades out and the next image fades in

8 Use the four-way controller (▲▼) to select [Sound Effect].**9 Use the four-way controller (◀▶) to select (On) or (Off).**

Except when the screen effect is set to Off, you can choose (On) or (Off) for the sound that is played when one image changes to the next.

10 Press the OK button.

The slideshow starts using the selected interval and effect.



- The slideshow will continue until you press any button other than the **OK** button or the power switch.
- Movies or pictures with sound will normally be played through to the end before the next picture is played back, regardless of the interval setting. However, pressing the four-way controller (▶) while playing back a movie or a picture with sound skips to the next image.
- Sound files made in Voice Recording mode are not played back in the slideshow.

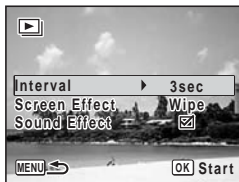



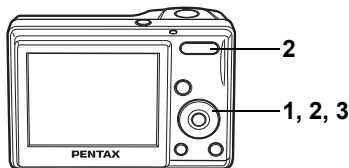

Playing Back Movies



Playing Back a Movie









You can play back the movies you have taken. Sound is played back at the same time.

1 Enter the  mode and use the four-way controller ( ) to choose the movie you want to play back.



2 Press the four-way controller ().
Playback starts.



The following operations can be performed during playback.

- Four-way controller () Reverse playback
- Four-way controller () Pause
- Zoom// button () Increases the volume
- Zoom// button () Reduces the volume

The following operations can be performed while playback is paused.

- Four-way controller () Frame reverse
- Four-way controller () Frame forward
- Four-way controller () Releases the Pause function (Play)

3 Press the four-way controller ().
Playback stops.

Connecting the Camera to AV Equipment

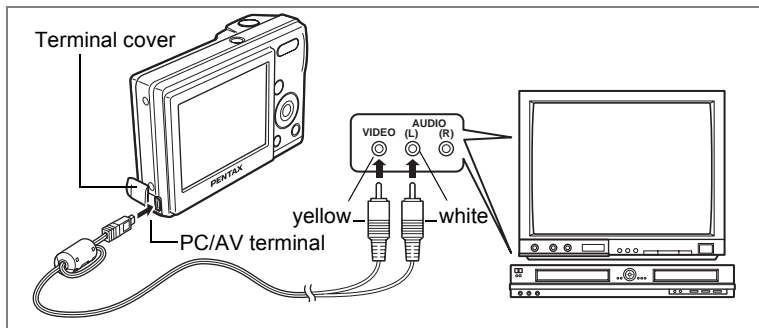

By using the AV cable, you can capture and play back images on equipment with a video IN jack, such as a TV. Make sure the camera and TV are turned off before connecting the camera to the TV.

5

Playing Back and Deleting Images

- 1 Open the terminal cover and connect the AV cable to the PC/AV terminal.**
- 2 Connect the other ends of the AV cable (yellow: video, white: audio) to the AV device's video input terminal and audio input terminal.**

When using stereo sound equipment, insert the sound terminal into the L (white) terminal.

- 3 Turn the AV device on.**

When the device that the camera is connected to and the device that plays back images are different, turn both devices on.

When viewing images on AV equipment with multiple video input terminals (such as a TV), refer to the operation manual of the device and select the video input terminal to which the camera is connected.

- 4 Turn the camera on.**



- You are recommended to use the AC adapter kit K-AC51 (optional) if you intend to use the camera for a long time.
- Depending on the country or region, images and sound files may fail to be played back if the video output format is set different from the one in use there. If this happens, change the video output format setting. (p.138)
- The camera LCD monitor turns off while the camera is connected to AV equipment.
- Volume cannot be adjusted with the zoom button while the camera is connected to AV equipment.

Deleting Images

Delete images and sounds with mistakes or that are unnecessary.

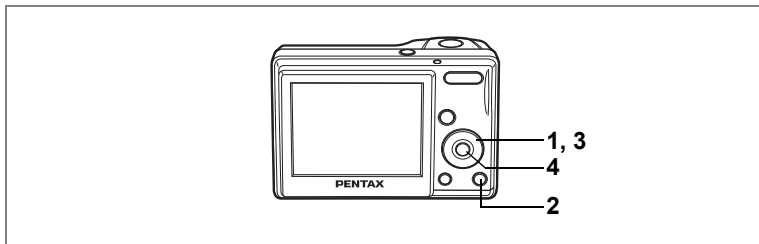

Deleting Single Images/Sound Files

You can delete single images and sound files one at a time.



Protected images and sound files cannot be deleted. (p.108)



- 1 Enter the mode and use the four-way controller () to choose the image/sound file you want to delete.**
- 2 Press the button.**
The confirmation screen appears.
- 3 Use the four-way controller () to select [Deletion].**
- 4 Press the OK button.**
The image or sound file is deleted.



If you press the button during Instant Review, the screen in Step 2 appears, enabling you to delete the image you have just taken. (p.41)

Deleting a Sound File

If sound has been recorded with an image (p.127), you can delete the sound without deleting the image.

1 Enter the  mode and use the four-way controller ( ) to choose an image with sound.

2 Press the  button.

The confirmation screen appears.

3 Use the four-way controller ( ) to select [Sound Deletion].

4 Press the OK button.

The sound file is deleted.



5

Playing Back and Deleting Images



Select [Deletion] in Step 3 above to delete both the image and sound file.

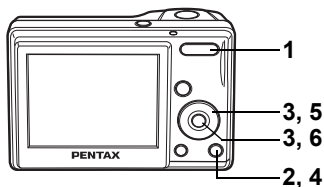

Deleting Selected Images and Sound Files (from Nine-Image Display)

You can delete several images/sound files selected from the nine-image display at once.

Caution:

Protected images and sound files cannot be deleted.

- 1 In \triangleright mode, press \square on the Zoom/ \square /Q button.**

Nine thumbnail images appear.

- 2 Press the \square button.**

\square appears on the images and sound files.



- 3 Use the four-way controller (\blacktriangle \blacktriangledown \blacktriangleleft \blacktriangleright) to choose the images and sound files that you want to delete and press the OK button.**

\square appears on the selected images and sound files.

If you select an image and press Q on the Zoom/ \square /Q button, the selected image appears in single-image display for as long as the button is pressed, enabling you to check whether you really want to delete it or not. (The display returns to the nine-image display when you release the button.) However, protected images cannot be displayed in single-image display.



4 Press the  button.

A confirmation dialog appears.

5 Use the four-way controller ( ) to select [Select & Delete].

6 Press the OK button.

The selected images and sound files are deleted.



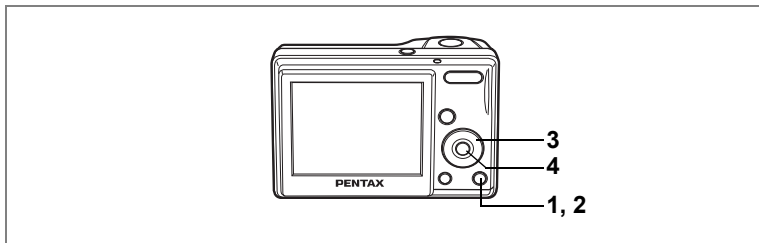

Deleting All Images

You can delete all the images and sound files at once.



Protected images and sound files cannot be deleted. (p.108)

- 1 Press the button in mode.**
A confirmation dialog appears.
- 2 Press the button.**
A confirmation dialog appears.
- 3 Use the four-way controller () to select [Delete All].**
- 4 Press the OK button.**
All the images and sound files are deleted.

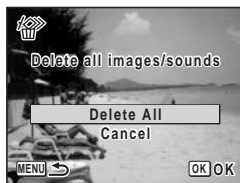

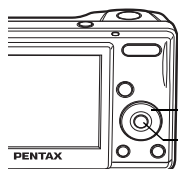

1, 2, 4, 6
3, 5, 7



Protecting Images and Sound Files from Deletion (Protect)

You can protect stored images and sound files from being accidentally deleted.

- 1 Press the four-way controller (▼) in [▶] mode.**
The Playback Mode Palette appears.
- 2 Use the four-way controller (▲▼◀▶) to select [Protect].**
- 3 Press the OK button.**
The screen for selecting [Select image/sound] or [All Images/Sounds] appears.
- 4 Use the four-way controller (▲▼) to select [Select image/sound].**
- 5 Press the OK button.**
The message [Protect this image/sound] appears. To protect another image or sound file, use the four-way controller (◀▶) to select another image or sound file.
- 6 Use the four-way controller (▲▼) to select [Protect].**
- 7 Press the OK button.**
The selected image or sound file is protected.



- To cancel the Protect setting, select [Unprotect] in Step 6.
- [] appears below the file number on protected images and sound files during playback.



Protecting All Images and Sound Files

- 1 Press the four-way controller (▼) in [▶] mode.**
The Playback Mode Palette appears.
- 2 Use the four-way controller (▲▼◀▶) to select [Protect].**
- 3 Press the OK button.**
The screen for selecting [Select image/sound] or [All Images/Sounds] appears.
- 4 Use the four-way controller (▲▼) to select [All Images/Sounds].**
- 5 Press the OK button.**
The screen for selecting [Protect] or [Unprotect] appears.
- 6 Use the four-way controller (▲▼) to select [Protect].**
- 7 Press the OK button.**
All the images and sound files are protected.



Protected images and sound files will be deleted when the SD Memory Card or built-in memory is formatted.



To cancel the Protect setting on all your images and sound files, select [Unprotect] in Step 6.

Editing Images

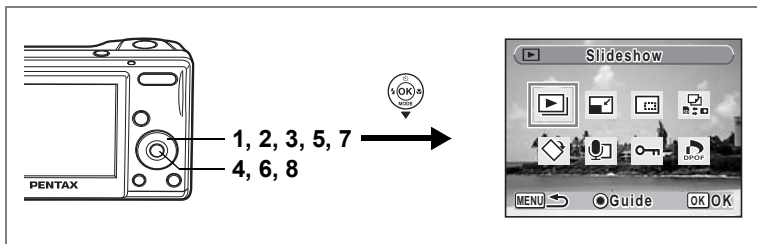

Changing the Image Size and Quality (Resize)

By changing the size and quality of a selected image, you can make the file size smaller than the original. You can use this function to continue taking pictures when the SD Memory Card or built-in memory is full, by making the images smaller and overwriting the original images to make more space available.



- Movies cannot be resized.
- You cannot select a larger resolution or higher quality than that of the original image.

6

- 1 Enter the mode and use the four-way controller () to choose the image you want to resize.**
- 2 Press the four-way controller ().**
The Playback Mode Palette appears.
- 3 Use the four-way controller () to select (Resize).**
- 4 Press the OK button.**
The screen for choosing the size and quality appears.
- 5 Select [Recorded Pixels] and [Quality Level].**

Use the four-way controller () to choose the size and quality.

Use the four-way controller () to switch between [Recorded Pixels] and [Quality Level].



6 Press the OK button.

A confirmation dialog for overwriting the image appears.
[Save as] is the only available option for protected images.

7 Use the four-way controller (▲▼) to select [Overwrite] or [Save as].

8 Press the OK button.

The resized image is saved.

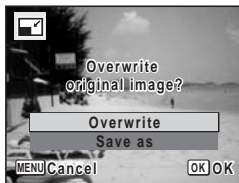







Trimming Images

You can delete the unwanted part of a picture and save the trimmed image as a separate image.

1 Enter the  mode and use the four-way controller ( ) to choose the image you want to trim.

2 Press the four-way controller ().
The Playback Mode Palette appears.

3 Use the four-way controller (   ) to select  (Trimming).

4 Press the OK button.
The Trimming screen appears.

5 Choose the trimming conditions.
Zoom//Q button

Changes the size of the trimmed section

Four-way controller (   )

Moves the trimming position up, down, left and right

Green button Rotates the trimming frame

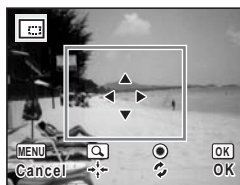

6 Press the OK button.

The trimmed image is saved with a new file name.

The trimmed image is saved in the same quality as the original image. The number of recorded pixels is selected automatically according to the size of the trimmed section.



Movies cannot be trimmed.

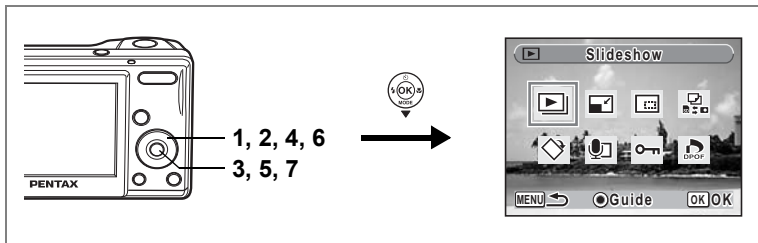

Copying Images and Sound Files

You can copy images and sound files from the built-in memory to the SD Memory Card and vice versa. This function can only be selected when an SD Memory Card has been inserted in the camera.



Make sure that the camera is turned off before inserting or removing the SD Memory Card.

- 1 Press the four-way controller (▼) in [▶] mode.**
The Playback Mode Palette appears.
- 2 Use the four-way controller (▲▼◀▶) to select .**
(Image/Sound Copy).
- 3 Press the OK button.**
The copying method selection screen appears.

To Copy Files from the Built-in Memory to the SD Memory Card

All the images and sound files in the built-in memory are copied to the SD Memory Card at once. Before copying the images, make sure that there is enough space in the SD Memory Card.

- 4 Use the four-way controller (▲▼) to select [ → SD].**
- 5 Press the OK button.**
All the images and sound files are copied.



To Copy Files from the SD Memory Card to the Built-in Memory

Selected images and sound files from the SD Memory Card are copied to the built-in memory one at a time.

- 4 Use the four-way controller (▲▼) to select [SD] → [●].
- 5 Press the OK button.
- 6 Use the four-way controller (◀▶) to select the file you want to copy.
- 7 Press the OK button.



The selected image/sound file is copied.



- If sound has been recorded with the image, the sound file is copied with the image.
- When a file is copied from the SD Memory Card to the built-in memory, it is assigned a new file name.

Setting the Printing Service (DPOF)

DPOF (Digital Print Order Format) is the format for storing print order data on still pictures captured with a digital camera. Once the print order data has been stored, the pictures can be printed according to the DPOF settings using a DPOF-compatible printer or photo processing lab. You cannot store print order data for movies or sound-only files.

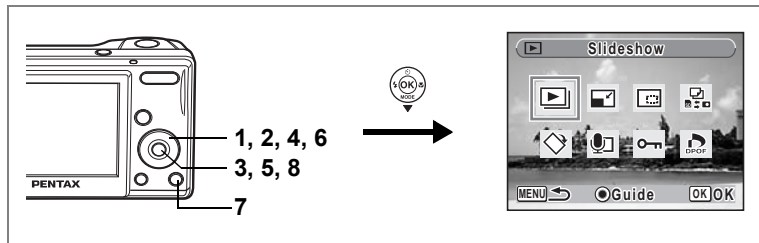

Printing Single Images

Set the following items for each image.

Copies	Choose the number of copies up to 99.
Date	Specify whether you want the date inserted on the print or not.

- 1 Press the four-way controller (▼) in [▶] mode.**
The Playback Mode Palette appears.
- 2 Use the four-way controller (▲▼◀▶) to select [DPOF].**
- 3 Press the OK button.**
The screen for selecting [Select image] or [All Images] appears.
- 4 Use the four-way controller (▲▼) to select [Select image].**



5 Press the OK button.

The message [DPOF setting for this image] appears. To make DPOF settings for another image, use the four-way controller (◀▶) to select another image.

If DPOF settings have already been made for an image, the previous number of copies and date setting (☑ or ☐) will be displayed.

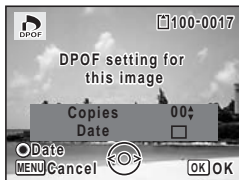

6 Use the four-way controller (▲▼) to choose the number of copies.

7 Use the Green button to choose whether to insert the date or not.

☑ (On) : The date will be imprinted.

☐ (Off) : The date will not be imprinted.

To continue setting DPOF print order data, use the four-way controller (◀▶) to choose another image and repeat Steps 6 and 7.



8 Press the OK button.

The DPOF settings are saved and the screen returns to the DPOF menu.



Depending on the printer or printing equipment at the photo processing lab, the date may not be imprinted on the pictures even if ☑ (On) was selected in the DPOF settings.



To cancel DPOF settings, set the number of copies to [00] in Step 6 and press the **OK** button.



Printing All Images

When you choose the number of copies and whether or not to insert the date, the settings are applied to all the images stored in the camera.

- 1 Display the screen for DPOF settings in mode.**
Refer to Steps 1 to 3 on p.115.
- 2 Use the four-way controller () to select [All Images].**
- 3 Press the OK button.**

The message [DPOF setting for all images] appears.

- 4 Choose the number of copies and whether to insert the date or not.**

Refer to Steps 6 and 7 in "Printing Single Images" (p.116) for details of how to make the settings.

- 5 Press the OK button.**

The DPOF settings for all the images are saved and the camera returns to the DPOF setting screen.



The number of copies specified in the DPOF settings applies to all the images. Before printing, check that the number is correct.



Settings for single images are canceled when settings are made for all images.

Printing Using PictBridge

By connecting the camera to a printer that supports PictBridge using the USB cable (I-USB7) provided, you can print images directly from the camera without using a PC. Connect the camera to the printer and select the images you want to print and the number of copies on the camera.



- You are recommended to use the AC adapter kit K-AC51 when the camera is connected to the printer. The printer may not work properly or the image data may be lost if the batteries run out of power while the camera is connected to the printer.
- Do not disconnect the USB cable during data transfer.
- Depending on the type of printer, not all the settings made on the camera (such as print settings and DPOF settings) may be valid.
- A printing error may occur if the selected number of copies exceeds 500.
- Printing the index of the images (printing multiple images on a single sheet) cannot be performed directly from the camera. Make the settings on a printer supporting index printing function or use a PC.

6

Connecting the Camera to the Printer

- 1 Select [PictBridge] for the [USB Connection] mode on the [X] Setting] menu.**
Refer to “Changing the USB Connection Mode” (p.137).
- 2 Turn off the camera.**
- 3 Connect the camera to the printer using the USB cable provided.**
- 4 Turn the printer on.**
- 5 When the printer is ready to print, turn the camera on.**

The printing mode selection screen appears.

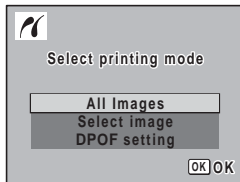

Printing Single Images

- 1 In the printing mode selection screen, use the four-way controller (▲▼) to select [Select image].**



- 2 Press the OK button.**

The setting screen appears.

- 3 Use the four-way controller (◀▶) to choose an image to print.**

- 4 Use the four-way controller (▲▼) to choose the number of copies.**

You can print up to 99 copies.



- 5 Use the Green button to choose whether to insert the date or not.**

(On) : The date will be imprinted.

(Off) : The date will not be imprinted.

- 6 Press the OK button.**

A confirmation dialog appears.

To print the pictures according to the print settings on the printer, press the **OK** button.

To change the print settings, go to Step 7.

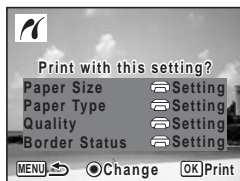

- 7 Press the Green button.**

The screen for changing the print settings appears.

- 8 Select [Paper Size] and press the four-way controller (▶).**

The Paper Size screen appears.

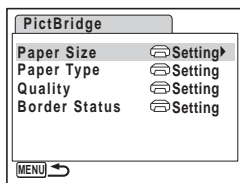

9 Use the four-way controller (▲▼◀▶) to choose the paper size.

You can only choose a size that is supported by your printer.

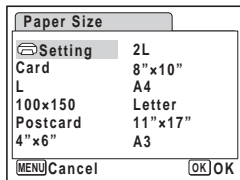

10 Press the OK button.

The Paper Size setting is saved, and the screen returns to the print settings screen.

11 Use the four-way controller (▲▼) to select [Paper Type] and press the four-way controller (▶).

A pull-down menu appears.

12 Use the four-way controller (▲▼) to select the paper type and press the OK button.

The Paper Type setting is saved, and the screen returns to the print settings screen. Set [Quality] and [Border Status] in the same way as in Steps 11 and 12.

If you select [☰ Setting] for each print setting, images are printed according to the settings made on the printer.

Paper Type with more ★ supports higher quality paper.

Quality with more ★ indicates higher print quality.

A confirmation dialog appears after each item has been set.

13 Press the MENU button.

The screen returns to the confirmation dialog.

14 Press the OK button.

The image is printed according to the settings.

Press the **MENU** button to cancel printing.



- The self-timer lamp lights while the camera is communicating with the printer, and blinks while the card is being accessed and during printing. Do not disconnect the USB cable while the self-timer lamp is blinking.
- The [Paper Size], [Paper Type], [Quality] and [Border Status] settings are reset to the defaults when the camera is turned off.

Disconnecting the Cable from the Printer p.122

Printing All Images

- 1 In the printing mode selection screen, use the four-way controller (▲▼) to select [All Images].**

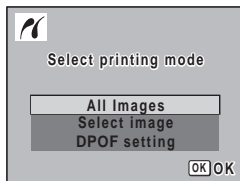

- 2 Press the OK button.**

The setting screen appears.

- 3 Choose the number of copies and whether to insert the date or not.**

The number of copies and date setting that you choose apply to all the images.

Refer to Steps 4 and 5 in "Printing Single Images" (p.119) for details of how to make the settings.

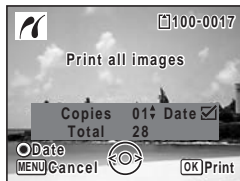

- 4 Press the OK button.**

A confirmation dialog appears.

Refer to Steps 7 to 11 of "Printing Single Images" (p.119 and p.120) for details of changing print settings.

- 5 Press the OK button on the print settings confirmation screen.**

All the images are printed according to the settings.

Press the **MENU** button to cancel printing.

Printing Using the DPOF Settings

1 In the printing mode selection screen, use the four-way controller (▲▼) to select [DPOF setting].

2 Press the **OK** button.

The DPOF settings you have made appear. Use the four-way controller (◀▶) to check the number of copies for each picture, whether to insert the date or not, and the total number of copies. Refer to p.115 for instructions on how to make the DPOF settings.

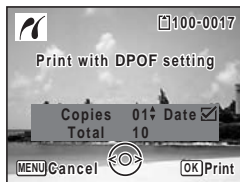

3 Press the **OK** button.

A confirmation dialog appears.

Refer to Steps 7 to 11 of “Printing Single Images” (p.119 and p.120) for details of changing print settings.

4 Press the **OK** button.

The images are printed according to the settings.

Press the **MENU** button to cancel printing.

6

Disconnecting the Cable from the Printer

Disconnect the USB cable from the camera and printer when you have finished printing.

1 Turn off the camera.

2 Disconnect the USB cable from the camera and printer.

Printing Using ImageLink

This camera is compatible with the ImageLink print system. Instead of using the USB cable to connect your camera to a printer or computer, place the supplied O-DI51 dock insert onto the Kodak EasyShare Printer Dock and then place the camera onto the dock insert to easily print out images.

Refer to the operating manual that came with your printer for information on how to print images and printer details.



Some printer functions may not work when using the camera with a printer dock.

Recording Sound (Voice Recording Mode)

You can record sound with the camera. The microphone is located below the lens on the camera. When recording sound, aim the camera to obtain the best conditions.

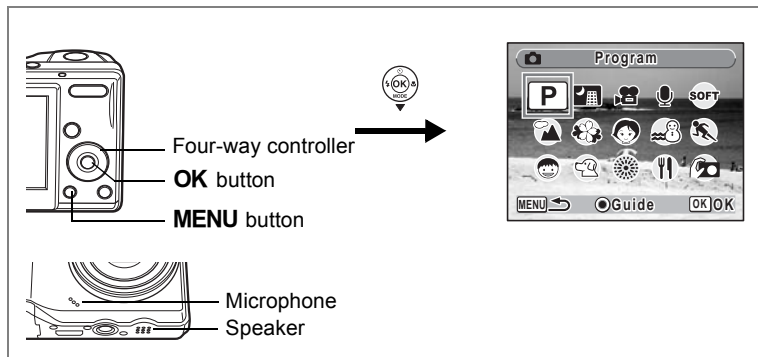

- 1 Press the four-way controller (▼) in mode.**
The Capture Mode Palette appears.
- 2 Use the four-way controller (▲▼◀▶) to select (Voice Recording).**

- 3 Press the OK button.**
The remaining recordable time and the recording time of the current file appear on the LCD monitor.
1 Recording time
2 Remaining recordable time

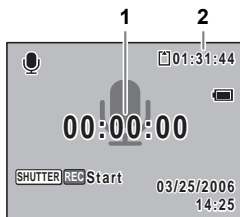

- 4 Press the shutter release button fully.**
Recording starts. The self-timer lamp blinks during recording.
When the Green button is pressed during recording, an index can be added to the current sound file.



5 Press the shutter release button fully.

Recording stops.





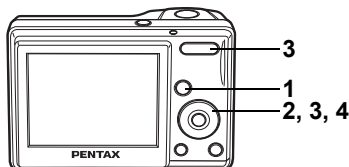

- If you press and hold down the shutter release button for more than one second in Step 4, recording continues until you take your finger off the button.
- Sound is saved in WAVE monaural files.

Playing Back Sound

You can play back the sound files you made in  mode.



- 1 Press the  button.**
- 2 Use the four-way controller ( ) to choose a sound file to play back.**
- 3 Press the four-way controller ().**

The sound file is played back.

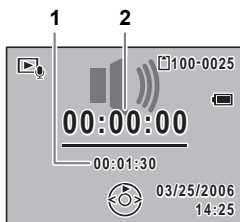

1 Total file recording time

2 Playback time



The following operations can be performed during playback.

Four-way controller () Pauses playback

Zoom/ button () Increases the volume

Zoom/ button () Reduces the volume

If there are no recorded indexes:

Four-way controller () Reverses playback

Four-way controller () Fast forwards playback

If there are recorded indexes:

Four-way controller () Plays back starting from the previous index

Four-way controller () Plays back starting from the next index

The following operations can be performed while playback is paused.

Four-way controller () Resumes playback

Four-way controller () Rewinds approx. 5 seconds

Four-way controller () Advances approx. 5 seconds

- 4 Press the four-way controller ().**







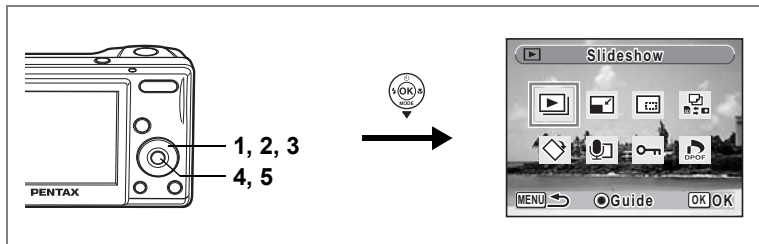

Playback stops.

Adding a Voice Memo to Images

You can add a voice memo to your still pictures.



Recording a Voice Memo

- 1 Enter  mode and use the four-way controller ( ) to choose the still picture to which you want to add a voice memo.**
- 2 Press the four-way controller ().**
The Playback Mode Palette appears.
- 3 Use the four-way controller (   ) to select  (Voice Memo).**
- 4 Press the OK button.**
Recording starts. You can record until the SD Memory Card or built-in memory is full.
- 5 Press the OK button.**
Recording stops.



- A voice memo cannot be added to an image that already has a voice memo. Delete the old voice memo and record a new one. (p.104)
- A voice memo cannot be added to protected () images (p.108).

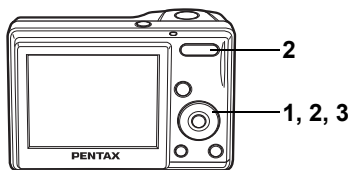

Playing Back a Voice Memo

- 1 Enter the Playback mode and use the four-way controller (◀▶) to choose the still picture with the voice memo that you want to play back.**

⏮ appears on images with voice memos in single-image display.



- 2 Press the four-way controller (▲).**

Playback starts.

The following operations can be performed during playback.

Zoom/▲▲▲/▲ button (▲) Increases the volume

Zoom/▲▲▲/▲ button (▲▲▲) Reduces the volume

- 3 Press the four-way controller (▼).**

Playback stops.

Deleting a Sound File p.104

Camera Settings

How to display the [Setting] menu

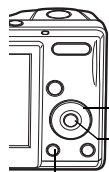

Four-way controller

OK button

MENU button

MENU

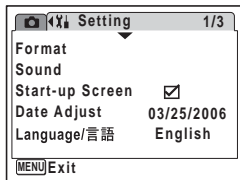

Formatting an SD Memory Card or the Built-in Memory

Formatting will delete all the data on the SD Memory Card.

All the data in the built-in memory will be deleted if no SD Memory Card is inserted in the camera.

Caution

- Do not remove the SD Memory Card during formatting as this may damage the card and render it unusable.
- Formatting will delete protected images and any data recorded on the card with a camera other than this camera.
- SD Memory Cards formatted on a PC or device other than the camera cannot be used. Be sure to format the card with the camera.

- 1 Use the four-way controller (▲▼) to select [Format] on the [Setting] menu.**
- 2 Press the four-way controller (▶).**
The Format screen appears.
- 3 Use the four-way controller (▲▼) to select [Format].**
- 4 Press the OK button.**

Formatting starts. When formatting is completed, the camera returns to Capture mode or Playback mode.

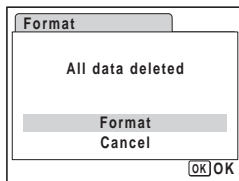

How to display the [Setting] menu



Four-way controller

OK button

MENU button

MENU

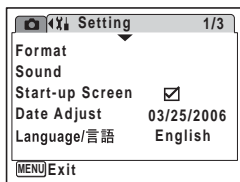

Changing the Sound Settings

You can adjust the volume of operation sounds and change the type of sound.

- 1 Use the four-way controller (▲▼) to select [Sound] on the [Setting] menu.**
- 2 Press the four-way controller (▶).**
The Sound screen appears.

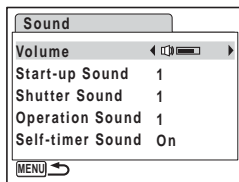

Changing the Operation Volume

- 3 Use the four-way controller (▲▼) to select [Volume].**
- 4 Use the four-way controller (◀▶) to adjust the volume.**
The selected volume is saved.
Set the volume to 0 to mute the start-up sound, shutter sound, operation sound, and self-timer sound.

Changing the Sound Type

- 5 Use the four-way controller (▲▼) to select [Start-up Sound].**
- 6 Press the four-way controller (▶).**
A pull-down menu appears.

7 Use the four-way controller (▲ ▼) to select [1], [2], [3] or [Off] and press **OK** button.

The selected sound type is saved.

8 Set [Shutter Sound], [Operation Sound] and [Self-timer Sound] in the same way as in Steps 5 to 7.

Select [On] or [Off] for the self-timer sound.

9 Press the **MENU** button.

The screen returns to the [⏏ Setting] menu with the changed setting.

How to display the [X Setting] menu



Four-way controller
OK button
MENU button

MENU

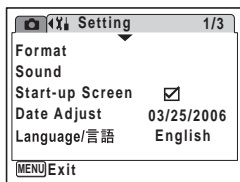

Changing the Start-up Screen

You can set the start-up screen to be displayed when the camera is turned on. Choose from three images. You can also set the start-up screen to not be displayed.

- 1 Use the four-way controller (▲▼) to select [Start-up Screen] on the [X Setting] menu.**
- 2 Press the four-way controller (▶).**
The image selection screen appears.
- 3 Use the four-way controller (◀▶) to choose the start-up screen.**
Select [Off] to not display the start-up screen.
- 4 Press the OK button.**
The Start-up Screen setting is saved.

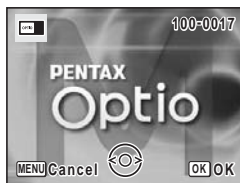

The Start-up Screen setting is displayed as when an image is selected for the start-up screen or when [Off] is selected.



How to display the [X Setting] menu



Four-way controller
OK button
MENU button

MENU

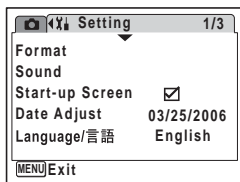

Changing the Date and Time

You can change the initial date and time settings. You can also set the style in which the date appears on the camera.

- 1 Use the four-way controller (▲▼) to select [Date Adjust] on the [X Setting] menu.**
- 2 Press the four-way controller (▶).**
The Date Adjust screen appears.

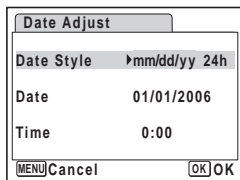

- 3 Press the four-way controller (▶).**
The frame moves to [mm/dd/yy].
Depending on the initial setting or previous setting, [dd/mm/yy] or [yy/mm/dd] may be displayed.

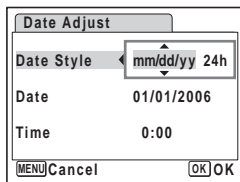

- 4 Use the four-way controller (▲▼) to choose the date display style.**
Choose [mm/dd/yy], [dd/mm/yy] or [yy/mm/dd].
- 5 Press the four-way controller (▶).**
The frame moves to [24h].
- 6 Use the four-way controller (▲▼) to select [24h] (24-hour display) or [12h] (12-hour display).**

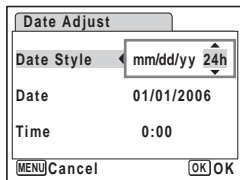

7 Press the four-way controller (▶).

The frame returns to [Date Style].

8 Press the four-way controller (▼).

The frame moves to [Date].

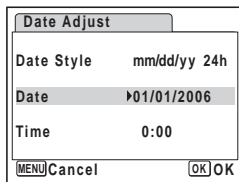

9 Press the four-way controller (▶).

The frame moves to one of the following items depending on the date style set in Step 4.

For [mm/dd/yy] month (Example: [01])

For [dd/mm/yy] day (Example: [01])

For [yy/mm/dd] year (Example: [2006])

The following operations and screens use [mm/dd/yy] as an example. The operations are the same even if another date style has been selected.

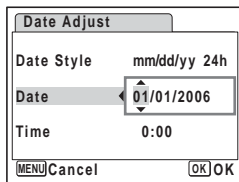

10 Use the four-way controller (▲▼) to change the month.

11 Press the four-way controller (▶).

The frame moves to the day field. Use the four-way controller (▲▼) to change the day. After changing the day, change the year in the same manner.

8

12 Change the time in the same way as in Steps 7 to 10.

If you selected [12h] in Step 6, the setting switches between am and pm corresponding to the time.

13 Press the OK button.

The date and time settings are saved.



When you finish the settings and press the **OK** button, the camera clock is reset to 00 seconds. To set the exact time, press the **OK** button when the time signal (on the TV, radio, etc.) reaches 00 seconds.

How to display the [Setting] menu



Four-way controller

OK button

MENU button

MENU

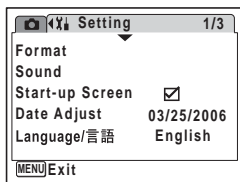

Changing the Display Language

You can change the language in which the menus, error messages, etc. are displayed.

You can choose from English, French, German, Spanish, Italian, Swedish, Dutch, Russian, Korean, Chinese (traditional and simplified) and Japanese.

- 1 Use the four-way controller (▲▼) to select [Language/言語] on the [Setting] menu.**
- 2 Press the four-way controller (▶).**
The Language/言語 screen appears.
- 3 Use the four-way controller (▲▼◀▶) to select the language.**
- 4 Press the OK button.**

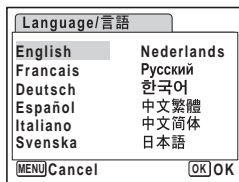

How to display the [X Setting] menu

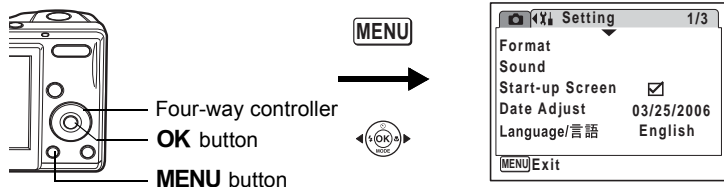

Changing the Image Folder Name

You can change the image folder name from the standard name to the date that pictures were taken. When the name is changed to the date, pictures are saved in separate folders by the date they were taken.

Folder Name

Standard	XXXPENTX (where XXX is the 3-digit folder number)
Date	XXX_mmdd (3-digit folder number_month day)

Picture taken with standard folder name (Example: March 25)

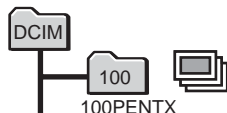

Folder name changed to date setting (Example: March 25)

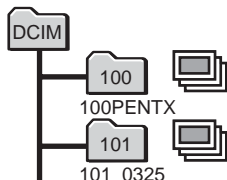

Next time a picture is taken (Example: April 1)

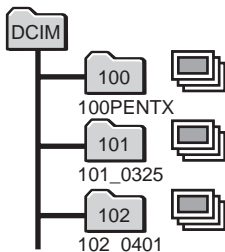

- 1 Use the four-way controller (▲▼) to select [Folder Name] on the [X Setting] menu.
- 2 Press the four-way controller (▶).
A pull-down menu appears.
- 3 Use the four-way controller (▲▼) to select [Standard] or [Date].
- 4 Press the OK button.
The Folder Name setting is saved.

How to display the [X Setting] menu



Four-way controller
OK button
MENU button

MENU

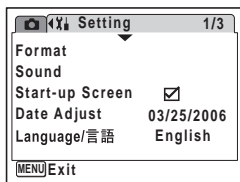

Changing the USB Connection Mode

Choose the appropriate USB connection mode depending on whether you are going to connect the USB cable to a PC or a PictBridge-compatible printer.



Refer to the PC Connection Manual for instructions on connecting the camera to a computer.

- 1 Use the four-way controller (▲▼) to select [USB Connection] on the [X Setting] menu.**
- 2 Press the four-way controller (▶).**
A pull-down menu appears.
- 3 Use the four-way controller (▲▼) to select [PC] or [PictBridge].**

[PC] : Select this option when transferring image data to a computer

[PictBridge] : Select this option when connecting the camera to a PictBridge-compatible printer

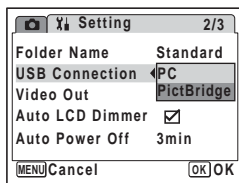

- 4 Press the OK button.**

The USB Connection setting is saved.



Do not connect the camera to your PC while [PictBridge] is selected for the USB Connection mode. And do not connect the camera to your printer while [PC] is selected.

How to display the [X Setting] menu



Four-way controller
OK button
MENU button

MENU

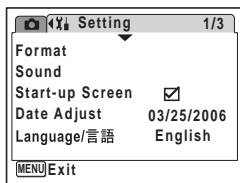

Changing the Video Output Format

When you connect the camera to AV equipment, choose the appropriate video output format (NTSC or PAL) for taking and playing back images.

- 1 Use the four-way controller (▲▼) to select [Video Out] on the [X Setting] menu.**
- 2 Press the four-way controller (▶).**
A pull-down menu appears.
- 3 Use the four-way controller (▲▼) to select [NTSC] or [PAL].**

Choose the video output format to match the output format of the AV equipment.

- 4 Press the OK button.**

The Video Out setting is saved.

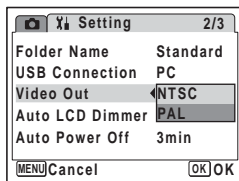

8

Settings



Depending on the country or region, images and sound files may fail to be played back if the video output format is set different from the one in use there. If this happens, change the video output format setting.

Connecting the Camera to AV Equipment  p.102

How to display the [X Setting] menu

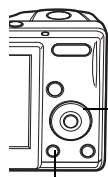

Four-way controller

MENU button

MENU

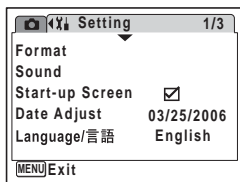

Automatically Adjusting the Brightness of the LCD Monitor (Auto LCD Dimmer)

You can use the Auto LCD Dimmer to automatically adjust the brightness of the LCD monitor to the optimal setting according to the surrounding brightness.

- 1 Use the four-way controller (▲▼) to select [Auto LCD Dimmer] on the [X Setting] menu.**
- 2 Use the four-way controller (◀▶) to select (On) or (Off).**

The following setting is saved.

On: The Auto LCD Dimmer is turned on.

Off: The Auto LCD Dimmer is turned off.

- 3 Press the MENU button.**

The camera returns to Capture mode or Playback mode.

To change the setting, perform the above steps again.

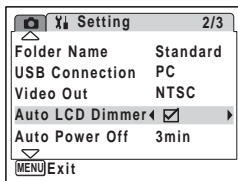

The Auto LCD Dimmer does not function in the following situations:

- in Playback mode
- while the camera is connected to a PC or printer
- while recording a movie

How to display the [X Setting] menu



Four-way controller

OK button

MENU button

MENU

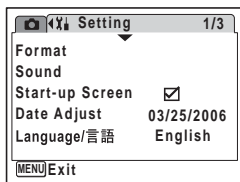

Setting Auto Power Off

You can set the camera to turn off automatically when no operation is performed for a fixed time.

- 1 Use the four-way controller (▲▼) to select [Auto Power Off] on the [X Setting] menu.**
- 2 Press the four-way controller (▶).**
A pull-down menu appears.
- 3 Use the four-way controller (▲▼) to select [5min], [3min] or [Off].**
- 4 Press the OK button.**
The Auto Power Off setting is saved.

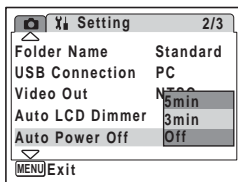

8

Settings



Auto Power Off does not function in the following situations:

- during a slideshow or movie playback
- while the camera is connected to a PC or printer

How to display the [X Setting] menu



Four-way controller

OK button

MENU button

MENU

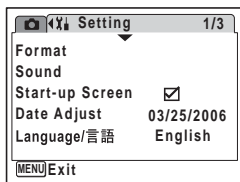

Resetting to Default Settings (Reset)

You can reset the camera settings to their defaults. Refer to “Default Settings” (p.142) for the reset settings.

- 1 Use the four-way controller (▲▼) to select [Reset] on the [X Setting] menu.**
- 2 Press the four-way controller (▶).**
The Reset screen appears.
- 3 Use the four-way controller (▲▼) to select [Reset].**
- 4 Press the OK button.**
The settings return to the defaults.

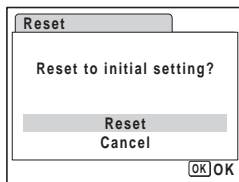

The following settings are not affected by resetting:

Date Adjust, Language/言語 and Video Out.

Default Settings

The table below lists the factory default settings.

The meaning of the indications for menu items with a default setting is explained below.

Last Memory Setting

Yes : The current setting (last memory) is saved when the camera is turned off.

No : The setting returns to the default setting when the camera is turned off.

* : The setting depends on the [Memory] setting (p.86).

Reset Setting

Yes : The setting returns to the default setting with the Reset function (p.141).

No : The setting is saved even after reset.

● [📷 Rec. Mode] Menu Items

Item		Default Setting	Last Memory Setting	Reset Setting	Page
Recorded Pixels		6M (2816×2112)	Yes	Yes	p.75
Quality Level		★★ (Better)	Yes	Yes	p.77
White Balance		AWB (Auto)	*	Yes	p.78
Focusing Area		[] (Multiple)	Yes	Yes	p.80
Sensitivity		Auto	*	Yes	p.81
EV Compensation		±0.0	*	Yes	p.68
Movie	Recorded Pixels	320 (320×240)	Yes	Yes	p.90
	Color Mode	Full Color	Yes	Yes	p.91
	Frame Rate	30fps	Yes	Yes	p.92
Digital Zoom		On	*	Yes	p.67
Instant Review		1 sec	Yes	Yes	p.82
Memory	Flash Mode	On	—	Yes	p.73
	Drive Mode	Off	—	Yes	p.62, p.63, p.64
	Focus Mode	Off	—	Yes	p.71
	Zoom Position	Off	—	Yes	p.66

Item		Default Setting	Last Memory Setting	Reset Setting	Page
Memory	MF Position	Off	—	Yes	p.72
	White Balance	Off	—	Yes	p.78
	Sensitivity	Off	—	Yes	p.81
	EV Compensation	Off	—	Yes	p.68
	Digital Zoom	On	—	Yes	p.67
	DISPLAY	Off	—	Yes	p.69, p.98
	File #	On	—	Yes	—
Sharpness		Normal	Yes	Yes	p.83
Saturation		Normal	Yes	Yes	p.84
Contrast		Normal	Yes	Yes	p.85

● [X] Setting] Menu Items















Item		Default Setting	Last Memory Setting	Reset Setting	Page
Sound	Volume	3	Yes	Yes	p.130
	Start-up Sound	1	Yes	Yes	
	Shutter Sound	1	Yes	Yes	
	Operation Sound	1	Yes	Yes	
	Self-timer Sound	On	Yes	Yes	
Start-up Screen		Optio Logo screen	Yes	Yes	p.132
Date Adjust	Date Style (date)	According to initial setting	Yes	No	p.36
	Date Style (time)	According to initial setting	Yes	No	
	Date	According to initial setting	Yes	No	
	Time	According to initial setting	Yes	No	
Language/ 言語		According to initial setting	Yes	No	p.34
Folder Name		Standard	Yes	Yes	p.136
USB Connection		PC	Yes	Yes	p.137
Video Out		According to initial setting	Yes	No	p.138

Item	Default Setting	Last Memory Setting	Reset Setting	Page
Auto LCD Dimmer	On	Yes	Yes	p.139
Auto Power Off	3 min	Yes	Yes	p.140
Quick Zoom	Off	Yes	Yes	p.97

● Playback Mode Palette Items

Item	Default Setting	Last Memory Setting	Reset Setting	Page
Slideshow	Interval	3 sec	Yes	p.99
	Screen Effect	Wipe	Yes	
	Sound Effect	On	Yes	

● Key Operation

Item	Function	Default Setting	Last Memory Setting	Reset Setting	Page
 button	Operation Mode	 mode	—	—	—
Zoom/     button	Zoom Position	Wide	*	Yes	p.66
Four-way controller	 Drive Mode	<input type="checkbox"/> (Normal)	*	Yes	p.62, p.63, p.64
	 Shooting Mode	 (Program)	Yes	Yes	p.51
	 Flash Mode	 _A (Auto)	*	Yes	p.73
	 Focus Mode	AF (Standard)	*	Yes	p.71
MENU button	Menu Display	Capture mode:  Rec. Mode] menu Playback mode: [ Setting] menu	—	—	p.46
OK/DISPLAY button	Information Display	Normal	*	Yes	p.69, p.98

Functions Available for Each Shooting Mode

Yes: Can be set and function is available.

No: Cannot be set.

#: Can be set but function is not available.

						SOFT			
(Auto)	Yes	Yes	Yes	No ^{*2}	No	Yes	Yes	Yes	No ^{*2}
(Flash Off)	Yes	Yes	Yes	Yes ^{*2}	No	Yes	Yes	Yes	Yes ^{*2}
(Flash On)	No	Yes	Yes	No ^{*2}	No	Yes	Yes	Yes	No ^{*2}
(Auto + Red-eye)	No	Yes	Yes	No ^{*2}	No	Yes	Yes	Yes	No ^{*2}
(Flash On + Red-eye)	No	Yes	Yes	No ^{*2}	No	Yes	Yes	Yes	No ^{*2}
(Self-timer)	Yes ^{*1}	Yes	Yes	Yes	No	Yes	Yes	Yes	Yes
(2 Sec. Self-timer)	Yes ^{*1}	Yes	Yes	Yes	No	Yes	Yes	Yes	Yes
(Continuous Shooting)	No	Yes	No	No	No	No	Yes	Yes	No
(Frame Composite)	Yes	Yes	Yes	No	No	Yes	Yes	Yes	Yes
AF (Standard)	Yes	Yes	Yes	No	No	Yes	Yes	Yes	No ^{*9}
(Macro)	Yes	Yes	Yes	No	No	Yes	Yes	Yes	No ^{*9}
(Infinity)	No	Yes	Yes	No	No	Yes	Yes	Yes	Yes ^{*9}
MF (Manual Focus)	No	Yes	Yes	No	No	Yes	Yes	Yes	No ^{*9}
Recorded Pixels	No	Yes	Yes	# ^{*3}	#	Yes	Yes	Yes	Yes
Quality Level	No	Yes	Yes	#	#	Yes	Yes	Yes	Yes
White Balance	No	Yes	No	Yes	# ^{*7}	No	No	No	No
Focusing Area	No	Yes	Yes	#	#	Yes	Yes	No ^{*8}	#
Sensitivity	No	Yes	Yes	Yes	#	Yes	Yes	Yes	No
EV Compensation	No	Yes	Yes	Yes ^{*4}	#	Yes	Yes	Yes	No
Movie	No	#	#	Yes	#	#	#	#	#
Digital Zoom	No	Yes	Yes	Yes ^{*5}	#	Yes	Yes	Yes	Yes
Instant Review	No	Yes	Yes	Yes	#	Yes	Yes	Yes	Yes
Memory	No	Yes	Yes	Yes ^{*6}	Yes ^{*6}	Yes	Yes	Yes	Yes
Sharpness	No	Yes	No	Yes	#	No	No	No	No
Saturation	No	Yes	No	Yes	#	No	No	No	No
Contrast	No	Yes	No	Yes	#	No	No	No	No

*1 The setting in a shooting mode other than Green Mode is available.

*2 Fixed at (Flash Off)

*3 Follows setting for [Movie]

*4 Not available during recording

*5 Only digital zoom is available while recording

*6 Only those functions that can be set can be saved

*7 (Manual) is not available

*8 Fixed at Automatic Tracking AF

*9 Fixed at (Infinity)

Optional Accessories

A number of dedicated accessories are available for this camera.

AC adapter kit K-AC51

This kit includes the DC coupler D-DC51, the AC adapter D-AC5 and the AC plug cord D-CO2.

The ending of the AC plug cord name differs depending on the country.

USB cable I-USB7 (*)

AV cable I-AVC7 (*)

Strap

O-ST51 (*)

O-ST24 Genuine leather strap

O-ST8 Silver chain strap

O-ST30

Camera case

O-CC51

Products marked with an asterisk (*) are the same as those supplied with the camera.

Messages

Messages such as the following may appear on the LCD monitor during camera operation.

Battery depleted	The batteries are exhausted. Replace with new batteries. If using rechargeable batteries, charge the batteries. (p.22)
Memory card full	The SD Memory Card is full and no more images can be saved. Insert a new SD Memory Card or delete unwanted images. (p.26, p.103) Change the quality level or recorded pixels of recorded images and try again. (p.110)
Memory card error	Shooting and playback are impossible due to a problem with the SD Memory Card. You may be able to display or copy the images on the card using a PC.
Card not formatted	The SD Memory Card you have inserted is unformatted or has been formatted on a computer or other device and is not compatible with this camera. (p.129)
Card locked	The SD Memory Card is write-protected. (p.28)
Compression error	This message appears when you have exceeded the capacity limit of the SD Memory Card while taking pictures.
No image/sound	There are no image/sound files on the SD Memory Card.
Movie recording stopped	This message appears when the internal temperature of the camera has exceeded normal operating limits while recording a movie.
Deleting	This message appears when deleting an image or sound file.
Camera cannot display this image	You are trying to play back an image or sound in a format not supported by this camera. You may be able to play it back on another brand of camera or your computer.
Image folder cannot be created	The largest file number (9999) has been assigned to an image in the largest folder number (999) and no more images can be saved. Insert a new SD Memory Card or format the card. (p.129)
Protected	The image or sound file you are trying to delete is protected.
Data being recorded	This message appears when you try to switch to  mode while an image is still being recorded, or when the protect setting or DPOF setting is being changed. It disappears after the image is recorded or the setting is changed.









Data being processed	This message appears when the camera takes more than five seconds to display an image due to image processing, or when the SD Memory Card or built-in memory is being formatted.
----------------------	--

Messages such as the following may appear on the LCD monitor when using the PictBridge function.

No paper in the printer	There is no paper in the printer.
No ink in the printer	There is no ink in the printer.
Printer error	An error message has been sent from the printer.
Data error	A data error message has been sent from the printer.
Paper stuck in the printer	The paper is stuck in the printer.

Troubleshooting

Problem	Cause	Remedy
Camera will not turn on	Batteries are not installed	Check if batteries are installed. If not, install batteries.
	Battery is installed incorrectly	Check orientation of batteries. Reinsert batteries according to the ⊕ ⊖ symbols on the battery compartment. (p.20)
	Battery power is low	Insert new batteries or use the AC adapter.
No image on LCD monitor	Camera is connected to a PC	LCD monitor is off when camera is connected to a computer.
	Camera is connected to a TV	LCD monitor is off when camera is connected to a TV.
	Image is displayed but is hard to see	Image on LCD monitor may be hard to see when taking pictures outside in sunlight.
Shutter will not release	Flash is charging	Pictures cannot be taken while the flash is charging. Wait until charging is finished.
	No available space on SD Memory Card or in the built-in memory	Insert SD Memory Card with available space or delete unwanted images. (p.26, p.103)
	Recording	Wait until recording is finished.
Picture is dark	Subject is too far away in a dark environment, such as a night scene	Picture becomes dark if subject is too far away. Take picture within range of flash.

Problem	Cause	Remedy
Subject is not in focus	Subject is difficult to focus on with autofocus	Lock focus on another object located at same distance (press shutter release button halfway), then aim at target and press shutter release button fully (p.39), or use Manual Focus mode. (p.72)
	Subject is not in focusing area	Position subject in focus frame in middle of LCD monitor. If the subject is outside the focusing area, aim the camera at the subject and lock the focus (press shutter release button halfway), then compose picture and press the shutter release button fully.
	Subject is too close	Set focus mode to  . (p.71)
	Focus mode is set to 	Normal pictures will be out of focus if taken with focus mode set to  .
Flash does not discharge	Flash mode is set to  (flash off)	Set to Auto or  (Flash On). (p.73)
	Drive mode is set to  Focus mode is set to  Shooting mode is set to  or 	Flash will not discharge in these modes.
USB connection with computer does not work properly	USB connection mode is set to [PictBridge]	Change the USB connection mode to [PC]. (p.137)
USB connection with printer does not work properly	USB connection mode is set to [PC]	Change the USB connection mode to [PictBridge]. (p.118)

Static electricity may occasionally prevent the camera from operating correctly. If this should occur, try removing and then reloading the batteries. If the camera turns on and operates properly, this indicates that there is no malfunction. You can use the camera as usual.

Main Specifications

Type	Fully automatic compact digital still camera with built-in zoom lens	
Effective Pixels	6.0 megapixels	
Sensor	6.18 megapixels (total pixels) 1/2.5 inch interline transfer CCD with a primary color filter	
Recorded Pixels	Still Picture	6M (2816×2112 pixels), 5M (2560×1920 pixels) 4M (2304×1728 pixels), 3M (2048×1536 pixels) 2M (1600×1200 pixels), 1024 (1024×768 pixels) 640 (640×480 pixels)
	Movie	320 (320×240 pixels), 160 (160×120 pixels)
Sensitivity	Auto, manual (64/100/200/400: Standard Output Sensitivity)	
File Format	Still Picture	JPEG (Exif 2.2), DCF, DPOF, PictBridge, PRINT Image Matching III
	Movie	MOV (QuickTime Motion JPEG), streaming video, approx. 30fps/15fps, PCM system, monaural sound, full color/sepia/black and white
	Sound	Voice memo, voice recording: WAVE (PCM) system, monaural
Quality Level	Still Picture	★★★ "Best", ★★ "Better", ★ "Good"
Storage Medium	Built-in memory (approx. 22MB), SD Memory Card	

Approximate Image Storage Capacity and Recording Time

Still Picture

	★★★ (Best)		★★ (Better)		★ (Good)	
	Built-in Memory	128MB	Built-in Memory	128MB	Built-in Memory	128MB
6M 2816×2112	7 pictures	41 pictures	14 pictures	83 pictures	22 pictures	124 pictures
5M 2560×1920	8 pictures	49 pictures	17 pictures	95 pictures	24 pictures	137 pictures
4M 2304×1728	11 pictures	62 pictures	22 pictures	124 pictures	31 pictures	178 pictures
3M 2048×1536	13 pictures	77 pictures	27 pictures	153 pictures	40 pictures	223 pictures
2M 1600×1200	22 pictures	124 pictures	37 pictures	206 pictures	54 pictures	301 pictures
1024 1024×768	43 pictures	244 pictures	74 pictures	412 pictures	93 pictures	522 pictures
640 640×480	87 pictures	489 pictures	127 pictures	712 pictures	175 pictures	979 pictures

The image storage capacity is for reference only. The actual image storage capacity may vary depending on the SD memory card and the subject.

Movie

	30fps		15fps		Sound	
	Built-in Memory	128MB	Built-in Memory	128MB	Built-in Memory	128MB
320 320×240	33 sec.	3 min. 6 sec.	1 min. 3 sec.	5 min. 55 sec.	47 min. 57 sec.	4 hr. 27 min. 19 sec.
160 160×120	2 min. 7 sec.	11 min. 51 sec.	3 min. 54 sec.	21 min. 45 sec.		

The recording time is for reference only. The actual recording time may vary depending on the SD memory card and the subject.

White Balance	Auto, Daylight, Cloudy, Tungsten Light, Fluorescent Light, Manual		
Lens	Focal Length	5.8 mm - 17.4 mm (equivalent to 35 mm - 105 mm in 35 mm format)	
	Aperture	f/2.8 - f/4.9	
	Lens Composition	6 elements in 5 groups (two aspherical elements)	
	Zoom Type	Electrically driven	
	Picture Range	Approx. 104.6 mm × 78.4 mm (screen is filled) (Macro mode)	
	Lens Cover	Electrically driven	
Digital Zoom	Capture Mode	Max. 4× (combines with 3× optical zoom to give zoom magnification equivalent to 12×)	
LCD Monitor	2.5-inch low-reflection TFT color LCD monitor (with backlight) with automatic brightness adjustment using ambient light sensor, approx. 115 kilopixels		
Playback Functions	Single-frame, 9-frame index, enlargement (max. 8×, scroll), folder display, rotating, sound playback, voice memo playback, slideshow, movie playback, histogram display, bright/dark portion display, image/sound copying, trimming, resizing, protect, DPOF		
Focus Modes	Autofocus, Macro, Infinity, Manual Focus		
	Type	TTL contrast detection system by sensor 9-point autofocus (multiple/spot/automatic tracking AF changeable)	
	Still Picture (from lens front)	Normal	: Approx. 0.7 m - ∞ (full zoom range)
		Macro	: Approx. 0.1 m - 0.8 m (Wide) Approx. 0.4 m - 0.8 m (Tele)
		Landscape	: ∞ (full zoom range)
Manual focus		: Approx. 0.1 m - ∞ (Wide), approx. 0.4 m - ∞ (Tele)	
		* Continuous AF is available only when automatic tracking AF is set	
Focus Lock	By half-pressing shutter release button		

Exposure Mechanism	AE metering	TTL metering by sensor (multi-segment)
	EV Compensation	±2 EV (can be set in 1/3 EV steps)
Shooting Modes	Green, Program, Night Scene, Movie, Voice Recording, Soft, Landscape, Flower, Portrait, Surf & Snow, Sport, Kids, Pet, Fireworks, Food, Self-portrait	
Movie	Continuous Recording Time	Approx. 1 second - until built-in memory or SD Memory Card is full
Shutter	Type	Electronic/mechanical shutter
	Speed	Approx. 1/1500 sec. - 4 sec.
Flash	Type	Auto flash with red-eye reduction function
	Flash Modes	Auto (at low illumination), Flash Off, Flash On, Auto + Red-eye, Flash On + Red-eye, (Slow synchronization is possible only in Night Scene mode)
	Effective Range	Wide: Approx. 0.4 m - 4.0 m (Standard Output Sensitivity: in Auto condition) Tele: Approx. 0.4 m - 2.5 m (Standard Output Sensitivity: in Auto condition)
Drive Modes	Single-frame, Self-timer (approx. 10 sec., approx. 2 sec.), Continuous, Frame Composite	
Self-timer	Electronic control type, control time: Approx. 10 sec., 2 sec.	
Power Supply	Two AA (alkaline, lithium, nickel manganese or Ni-MH) batteries, AC adapter kit (optional)	

Battery Life	Number of Recordable Images	
	220 pictures (AA alkaline batteries)*1	
	430 pictures (AA nickel manganese batteries)*1	
	640 pictures (AA NiMH batteries)*1	
	900 pictures (AA lithium batteries)*1	
	Playback Time	
	380 min. (AA alkaline batteries)*2	
	490 min. (AA nickel manganese batteries)*2	
	660 min. (AA NiMH batteries)*2	
	850 min. (AA lithium batteries)*2	
Movie Recording Time	90 min. (AA alkaline batteries)*2	
	120 min. (AA nickel manganese batteries)*2	
	230 min. (AA NiMH batteries)*2	
	310 min. (AA lithium batteries)*2	
	Sound Recording Time	
Sound Recording Time	430 min. (AA alkaline batteries)*2	
	540 min. (AA nickel manganese batteries)*2	
	740 min. (AA NiMH batteries)*2	
	1340 min. (AA lithium batteries)*2	
	* 1 Recording capacity shows approximate number of shots recorded during CIPA-compliant testing (with LCD monitor on, flash used for 50% of the shots, and 23 degrees centigrade). Actual performance may vary according to operating conditions.	
* 2 According to the result of in-house testing. Actual time may differ depending on usage conditions.		
In/Out Port	PC/AV terminal, DC input terminal	
Video Output Format	NTSC/PAL (monaural)	
PictBridge	Printer	PictBridge-compatible printer
	Print Modes	Print One, Print All, DPOF AUTOPRINT
	Paper Size	Card, L, 2L, Postcard, 100 mm×150 mm, 4"×6", 8"×10", Letter, 11"×17", A4, A3, printer setting
	Paper Type	★★★, ★★, ★, printer setting
	Quality	★★★, ★★, ★, printer setting
	Border Status	With/without, printer setting
ImageLink	Supported	
Size	89 (W) × 59.5 (H) × 24.5 (D) mm (excluding operating or protruding parts) 21.5 mm at the slimmest point (26.5 mm at the grip)	
Weight	120 g (excluding batteries and SD Memory Card)	
Weight When Shooting	165 g (including batteries and SD Memory Card)	
Accessories	Two AA alkaline batteries, USB cable, AV cable, software (CD-ROM), strap, dock insert, operating manual	

WARRANTY POLICY

All PENTAX cameras purchased through authorized bona fide photographic distribution channels are guaranteed against defects of material or workmanship for a period of twelve months from date of purchase. Service will be rendered, and defective parts will be replaced without cost to you within that period, provided the equipment does not show evidence of impact, sand or liquid damage, mishandling, tampering, battery or chemical corrosion, operation contrary to operating instructions, or modification by an unauthorized repair shop. The manufacturer or its authorized representatives shall not be liable for any repair or alterations except those made with its written consent and shall not be liable for damages from delay or loss of use or from other indirect or consequential damages of any kind, whether caused by defective material or workmanship or otherwise; and it is expressly agreed that the liability of the manufacturer or its representatives under all guarantees or warranties, whether expressed or implied, is strictly limited to the replacement of parts as hereinbefore provided. No refunds will be made on repairs by non-authorized PENTAX service facilities.

Procedure During 12-month Warranty Period

Any PENTAX which proves defective during the 12-month warranty period should be returned to the dealer from whom you purchased the equipment or to the manufacturer. If there is no representative of the manufacturer in your country, send the equipment to the manufacturer, with postage prepaid. In this case, it will take a considerable length of time before the equipment can be returned to you owing to the complicated customs procedures required. If the equipment is covered by warranty, repairs will be made and parts replaced free of charge, and the equipment will be returned to you upon completion of servicing. If the equipment is not covered by warranty, regular charges of the manufacturer or of its representatives will apply. Shipping charges are to be borne by the owner. If your PENTAX was purchased outside of the country where you wish to have it serviced during the warranty period, regular handling and servicing fees may be charged by the manufacturer's representatives in that country. Notwithstanding this, your PENTAX returned to the manufacturer will be serviced free of charge according to this procedure and warranty policy. In any case, however, shipping charges and customs clearance fees to be borne by the sender. To prove the date of your purchase when required, please keep the receipt or bills covering the purchase of your equipment for at least a year. Before sending your equipment for servicing, please make sure that you are sending it to the manufacturer's authorized representatives or their approved repair shops, unless you are sending it directly to the manufacturer. Always obtain a quotation for the service charge, and only after you accept the quoted service charge, instruct the service station to proceed with the servicing.

- This warranty policy does not affect the customer's statutory rights.
- The local warranty policies available from PENTAX distributors in some countries can supersede this warranty policy. Therefore, we recommend that you review the warranty card supplied with your product at the time of purchase, or contact the PENTAX distributor in your country for more information and to receive a copy of the warranty policy.



The CE Mark is a Directive conformity mark of the European Union.

For customers in USA

STATEMENT OF FCC COMPLIANCE

This device complies with Part 15 of the FCC Rules. Operation is subject to the following two conditions: (1) This device may not cause harmful interference, and (2) this device must accept any interference received, including interference that may cause undesired operation.

Changes or modifications not approved by the party responsible for compliance could void the user's authority to operate the equipment.

This equipment has been tested and found to comply with the limits for a Class B digital device, pursuant to part 15 of the FCC Rules.

These limits are designed to provide reasonable protection against harmful interference in a residential installation. This equipment generates, uses and can radiate frequency energy and, if not installed and used in accordance with the instructions, may cause harmful interference to radio communications. However, there is no guarantee that interference will not occur in a particular installation.

If this equipment does cause harmful interference to radio or television reception, which can be determined by turning the equipment off and on, the user is encouraged to try to correct the interference by one or more of the following measures:

- Reorient or relocate the receiving antenna.
 - Increase the separation between the equipment and receiver.
 - Connect the equipment into an outlet on a circuit different from that to which the receiver is connected.
- * Consult the dealer or an experienced radio/TV technician for help.

For customers in Canada

This Class B digital apparatus meets all requirements of the Canadian Interference - Causing Equipment Regulations.

Pour les utilisateurs au Canada

Cet appareil numérique de la classe B respecte toutes les exigences du Règlement sur le matériel brouilleur du Canada.

Declaration of Conformity

According to 47CFR, Parts 2 and 15 for
Class B Personal Computers and Peripherals

We: PENTAX Imaging Company
A Division of PENTAX of America, Inc.

Located at: 600 12th Street, Suite 300
Golden, Colorado 80401 U.S.A.
Phone: 303-799-8000 FAX: 303-790-1131

Declare under sole responsibility that the product identified herein complies with 47CFR Parts 2 and 15 of the FCC rules as a Class B digital device. Each product marketed is identical to the representative unit tested and found to be compliant with the standards. Records maintained continue to reflect the equipment being produced can be expected to be within the variation accepted, due to quantity production and testing on the statistical basis as required by 47CFR §2.909. Operation is subject to the following two conditions: (1) This device may not cause harmful interference, and (2) This device must accept any interference received, including interference that may cause undesired operation. The above named party is responsible for ensuring that the equipment complies with the standards of 47CFR §15.101 to §15.109.

Product Name: PENTAX Digital Still Camera

Model Number: Optio M10

Contact person: Customer Service Manager

Date and Place: February, 2006, Colorado

Information on disposal for users



1. In the European Union

If your product is marked with this symbol, it means that used electrical/electronic products should not be mixed with general household waste. There exists a separate collection system for these products.

Used electric/electronic equipment must be treated separately and in accordance with legislation that requires proper treatment, recovery and recycling of these products. Following the implementation by member states, private households within the EU states may return their used electrical/electronic equipments to designated collection facilities free of charge*. In some countries your local retailer may also take back your old product free of charge if you purchase a similar new one.

*Please contact your local authority for further details.

By disposing of this product correctly you will help ensure that the waste undergoes the necessary treatment, recovery and recycling and thus prevent potential negative effects on the environment and human health which could otherwise arise due to inappropriate waste handling.

2. In other countries outside the EU

If you wish to discard this product, please contact your local authorities and ask for the correct method of disposal.

For Switzerland: Used electrical/electronic equipment can be returned free of charge to the dealer, even when you don't purchase a new product. Further collection facilities are listed on the home page of www.swico.ch or www.sens.ch.

Symbols

[Rec. Mode] menu	49
mode	9, 93
button	42, 44
mode	9, 93
[Setting] menu	50
Green Mode	58
Green Button	43, 45
Delete	41, 103
Tele	66
Wide	66
Magnify	96
Nine-image display	94
Self-timer	62
Program	52, 57
Night Scene	52, 60
Movie	52
Voice Recording	52, 124
Landscape	52
Flower	52
Portrait	53
Surf & Snow	53
Sport	53
Kids	53
Pet	53, 61
SOFT Soft	52
Fireworks	53, 60
Self-portrait	54
Food	54
A	
AC adapter	23, 24
Adapter plug	24
Adding sound (Voice Memo)	127
Ambient light sensor	15
Auto 	73

Auto AWB	78
Auto LCD Dimmer	139
Auto Power Off	140
Autofocus	80
AV equipment	102

B













B&W	91
Basic mode	58
Batteries	20
Battery level indicator ...	22
Bright portions	17

C

Camera shake	66, 69
Changing volume	126, 130
Checking the memory card	32
Cloudy 	78
Color Mode	91
Computer	137
Connecting to a printer	118
Contrast	85
Copy	113

D

Dark portions	17
Date and time	36, 133
Daylight 	78
Default setting	34
Delete 	41, 103
Deleting sounds	104
Digital Zoom	67
Dock insert	123
DPOF printing	122
DPOF settings	115

F	
File #	86
Flash	73
Flash Off 	73
Flash On 	73
Fluorescent Light 	78
Focus Mode	71
Focusing	71
Focusing Area	80
Folder display	95
Format	129
Four-way controller	43, 45
Frame Rate	31, 92
Framing pictures 	64
G	
Green Button 	43, 45
Green Mode 	58
H	
Histogram	70
I	
ImageLink	123
Infinity 	71
Installing batteries	20
Instant Review	39, 82
L	
Language	34, 135
M	
MENU button	43, 45
Macro 	71
Magnify 	96
Manual Focus MF	71
Manual 	78
Memory	86
N	
Nine-image display 	94
NTSC	138
Number of pixels	75
Number of recordable images	30
O	
OK/DISPLAY button	43, 45
Optional accessory	146
P	
PAL	138
Photo processing lab	115
PictBridge	118
Playback	40, 93, 101, 126, 128
Playback Mode Palette	55
Playback Only Mode	33
Playing back movies	101
Playing back sounds	126
Power saving	139
Power supply	20, 32
Power switch	32, 42, 44
Press fully (shutter release button)	39
Press halfway (shutter release button)	39
Printing	118
Protect 	108
Q	
Quality Level	29, 77
Quick Zoom	97
R	
Recorded Pixels	29, 31, 75, 90
Recording movies	88
Recording sounds	124

Red-eye reduction	
	73, 74
Resetting settings	141
Resize	110
Rotating	41

S

Saturation	84
Saving by date	136
Saving settings	86
SD Memory Card	26
Self-timer 	62
Sensitivity	81
Sepia	91
Setting the exposure	68
Sharpness	83
Shooting information	69, 98
Shooting mode	51
Shutter release	
button	39, 42, 44
Slideshow	99
Sound settings	130
Sound types	130
Standard AF	71
Start-up Screen	132
Strap	19

T

Trimming	112
Tungsten Light 	78
TV	102

U

USB connection mode	137
---------------------------	-----

V

Video output format	138
Viewing a guide	56
Voice Memo	127

W

White Balance	78
---------------------	----

Z

Zoom 	66
Zoom button	42, 44

Memo

Memo

Memo

PENTAX Corporation	2-36-9, Maeno-cho, Itabashi-ku, Tokyo 174-8639, JAPAN (http://www.pentax.co.jp/)
PENTAX Europe GmbH (European Headquarters)	Julius-Vosseler-Strasse, 104, 22527 Hamburg, GERMANY (HQ - http://www.pentaxeurope.com) (Germany - http://www.pentax.de)
PENTAX U.K. Limited	PENTAX House, Heron Drive, Langley, Slough, Berks SL3 8PN, U.K. (http://www.pentax.co.uk)
PENTAX France S.A.S.	112 Quai de Bezons, B.P. 204 95106 Argenteuil Cedex, FRANCE (http://www.pentax.fr)
PENTAX Benelux B.V.	(for Netherlands) Spinveld 25, 4815 HR Breda, NETHERLANDS (http://www.pentax.nl) (for Belgium & Luxembourg) Weiveldlaan 3-5, 1930 Zaventem, BELGIUM (http://www.pentax.be)
PENTAX (Schweiz) AG	Widenholzstrasse 1 Postfach 367 8305 Dietlikon, SWITZERLAND (http://www.pentax.ch)
PENTAX Scandinavia AB	P.O. Box 650, 75127 Uppsala, SWEDEN (http://www.pentax.se)
PENTAX Imaging Company A Division of PENTAX of America, Inc.	(Headquarters) 600 12th Street, Suite 300 Golden, Colorado 80401, U.S.A. (PENTAX Service Department) 12000 Zuni Street, Suite 100B Westminster, Colorado 80234, U.S.A. (http://www.pentaximaging.com)
PENTAX Canada Inc.	1770 Argenta Road Mississauga, Ontario L5N 3S7, CANADA (http://www.pentax.ca)



for your
precious moments

<http://www.pentax.co.jp/english>

- Printed on recycled paper
- Specifications and external dimensions are subject to change without notice.