

PENTAX Corporation 2-36-9, Maeno-cho, Itabashi-ku, Tokyo 174-8639, JAPAN
(<http://www.pentax.co.jp/>)

PENTAX Europe GmbH (European Headquarters)
Julius-Vosseler-Strasse, 104, 22527 Hamburg, GERMANY
(HQ - <http://www.pentaxeurope.com>)
(Germany - <http://www.pentax.de>)

PENTAX U.K. Limited PENTAX House, Heron Drive, Langley, Slough, Berks
SL3 8PN, U.K.
(<http://www.pentax.co.uk>)

PENTAX France S.A.S. 112 Quai de Bezons, B.P. 204, 95106 Argenteuil Cedex, FRANCE
(<http://www.pentax.fr>)

PENTAX Italia S.r.l. Via Dione Cassio 15, 20138 Milano, ITALY
(<http://www.pentaxitalia.it>)

PENTAX (Schweiz) AG Widenholzstrasse 1, 8304 Wallisellen, Postfach 367 8305
Dietlikon, SWITZERLAND (<http://www.pentax.ch>)

PENTAX Scandinavia AB P.O. Box 650, 75127 Uppsala, SWEDEN
(<http://www.pentax.se>)

PENTAX Imaging Company
A Division of PENTAX of America, Inc.

(Headquarters)
600 12th Street, Suite 300
Golden, Colorado 80401, U.S.A.
(PENTAX Service Department)
12000 Zuni Street, Suite 100B
Westminster, Colorado 80234, U.S.A.
(<http://www.pentaximaging.com>)

PENTAX Canada Inc. 1770 Argentia Road Mississauga, Ontario L5N 3S7,
CANADA
(<http://www.pentax.ca>)

**PENTAX Trading
(SHANGHAI) Limited** 23D, Jun Yao International Plaza, 789 Zhaojiabang Road,
Xu Hui District, Shanghai, 200032 China



for your
precious moments

<http://www.pentax.co.jp/english>

• Specifications and external dimensions are subject to change without notice.

57954

Copyright © PENTAX Corporation 2008
11-200801 Printed in Philippines

PENTAX™



Optio A40

Digital Camera

Optio A40

Operating Manual

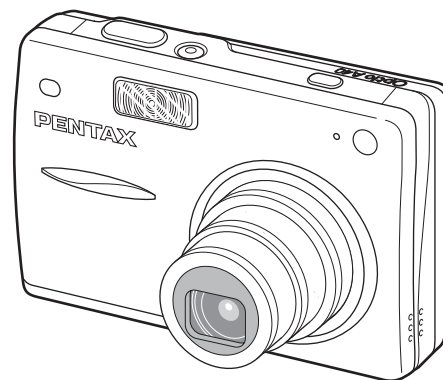

To ensure the best performance from your camera, please read the Operating Manual before using the camera.



Thank you for purchasing this PENTAX Digital Camera.

Please read this manual before using the camera in order to get the most out of all the features and functions. Keep this manual safe, as it can be a valuable tool in helping you to understand all the camera capabilities.

Regarding copyrights

Images taken using this PENTAX Digital Camera that are for anything other than personal enjoyment cannot be used without permission according to the rights as specified in the Copyright Act. Please take care, as there are even cases where limitations are placed on taking pictures even for personal enjoyment during demonstrations, performance or of items on display. Images taken with the purpose of obtaining copyrights also cannot be used outside the scope of use of the copyright as laid out in the Copyright Act, and care should be taken here also.

To users of this camera

- There is a possibility that recorded data may be erased or that the camera may not function correctly when used in surroundings such as installations generating strong electromagnetic radiation or magnetic fields.
- The liquid crystal panel used in the LCD display is manufactured using extremely high precision technology. Although the level of functioning pixels is 99.99% or better, you should be aware that 0.01% or fewer of the pixels may not illuminate or may illuminate when they should not. However, this has no effect on the recorded image.

Regarding trademarks

- PENTAX, Optio and smc PENTAX are trademarks of PENTAX Corporation.
- SDHC logo  is a trademark.
- All other brands or product names are trademarks or registered trademarks of their respective companies.

This product supports PRINT Image Matching III. PRINT Image Matching enabled digital still cameras, printers and software help photographers to produce images more faithful to their intentions. Some functions are not available on printers that are not PRINT Image Matching III compliant.

Copyright 2001 Seiko Epson Corporation. All Rights Reserved.

PRINT Image Matching is a trademark of Seiko Epson Corporation. The PRINT Image Matching logo is a trademark of Seiko Epson Corporation.

Red Eye software © 2003-2006 FotoNation Inc. Face Tracker software © 2005-2006 FotoNation Inc. In Camera Red Eye -- covered by U.S. Patent No. 6,407,777 and 7,042,505. Other patents Pending.

- There is a possibility that the illustrations and the display screen of the LCD monitor in this manual are different from the actual product.
- Both SD Memory cards and SDHC Memory cards are referred to as SD memory cards in this manual.

Using your camera safely

Sufficient attention has been paid to the safety of this product but please pay particular attention to the warnings indicated by the following symbols during use.



Warning

These symbols indicate that it is possible that the user may experience serious personal injuries if the warnings are not heeded.



Caution

These symbols indicate that it is possible that the user may experience minor or medium personal injuries, or material losses if the warnings are not heeded.

About the Camera



Warning

- Do not attempt to take the camera apart or remodel the camera. High voltages are present within the camera, and there is therefore a danger of electric shocks if the camera is taken apart.
- If the inside of the camera should become exposed as a result of, for example, the camera being dropped, please do not under any circumstances touch such exposed portions, as there is a danger of receiving an electric shock.
- Wrapping the strap of the camera around your neck is also dangerous. Please take care that small children do not hang the strap around their necks.
- To avoid the risk of it being swallowed by mistake, keep the SD Memory Card out of the reach of small children. Seek medical attention immediately if a memory card is accidentally swallowed.
- Use an AC adapter that is of the power and voltage specified for exclusive use with this product. The use of an AC adapter other than that specified exclusively for use with this product may cause fire or electric shocks.
- If the camera emits smoke or a strange smell, or in the event of any other irregularity, stop using the camera immediately, remove the battery or disconnect the AC adapter and contact your nearest PENTAX service center. Continued use of the camera may result in fire or electric shock.

Caution

- Never try to disassemble or short the battery. Also, do not dispose of the battery in fire, as it may explode.
- Do not charge any batteries other than the rechargeable lithium-ion battery D-LI8. The battery could explode or catch fire.
- Do not place your finger on the flash when it is discharging as there is a risk of burns.
- Do not discharge the flash while it is touching your clothing as there is a risk of discoloring.
- If any leakage from the battery should come in contact with your eyes, it may cause a loss of sight, do not rub them. Flush your eyes with clean water and get medical attention immediately.
- If any leakage from the battery should come in contact with skin or clothes, it may cause irritation to the skin, wash the affected areas thoroughly with water.
- Remove the battery from the camera immediately if it becomes hot or begins to smoke. Be careful not to burn yourself during removal.
- Some portions of the camera heat up during use, so please take care, as there is a risk of low temperature burns if such portions are held for long periods of time.
- Should the LCD be damaged, be careful of glass fragments. Also, be careful not to allow the liquid crystal to get on your skin or in your eyes or mouth.
- Depending on your inherent factors or physical conditions, the use of the camera may cause itching, rashes or blisters. In case of any abnormality, stop using the camera and get medical attention immediately.

Precautions for D-LI8 Battery Usage:

BATTERY MAY EXPLODE OR FIRE IF MISTREATED.

- DO NOT DISASSEMBLE OR DISPOSE OF IN FIRE.
- DO NOT CHARGE EXCEPT SPECIFIED CHARGING CONDITION.
- DO NOT HEAT ABOVE 140°F / 60°C, OR SHORT CIRCUIT.
- DO NOT CRUSH OR MODIFY.

About the Battery Charger and the AC Adapter

Warning

- Do not use the product at a voltage other than the specified voltage. Use with a power source or voltage other than that designed can cause a fire or electrical shock. The specified voltage is 100-240 V AC.

- Do not disassemble or modify the product. This can cause a fire or electrical shock.
- If the generation of smoke or strange odor from the product or other abnormality occurs, immediately discontinue using and consult a PENTAX Service Center. Continuing to use the product can cause a fire or electrical shock.
- If water should happen to get inside the product, consult a PENTAX Service Center. Continuing to use the product can cause a fire or electrical shock.
- If thunderstorm should be present during use of the battery charger or AC adapter, unplug the power cord and discontinue use. Continuing to use the product can cause damage to the equipment, fire or electrical shock.
- Wipe off the plug of the power cord if it should become covered with dust. This can cause a fire.



Caution

- Do not place heavy objects on the AC plug cord, allow heavy objects to drop onto it or allow the AC plug cord to become damaged due to excessive bending. If the AC plug cord becomes damaged, consult a PENTAX Service Center.
- Do not short or touch the output terminals of the product while it is still plugged in.
- Remove the battery and unplug the AC plug cord when not using the battery charger.
- Do not plug in the AC plug cord with wet hands. This can cause an electrical shock.
- Do not subject the product to strong impacts or allow it to drop onto a hard surface. This can cause a malfunction.
- To reduce the risk of hazards, use only CSA/UL Certified power supply cord set, cord is Type SPT-2 or heavier, minimum NO.18 AWG copper, one end with a molded-on male attachment plug cap (with a specified NEMA configuration), and the other is provided with a molded-on female connector body (with a specified IEC nonindustrial type configuration) or the equivalent.
- Do not use the battery charger to charge batteries other than the rechargeable lithium-ion battery D-Li8. This can cause overheating or malfunctions.

Care to be Taken During Handling

- Take the Worldwide Service Network listing that is included in the package with you when traveling. This will be useful if you experience problems abroad.
- When the camera has not been used for a long time, confirm that it is still working properly, particularly prior to taking important pictures (such as at a wedding or during traveling). Contents of a recording such as images and sounds cannot be guaranteed if recording, playback or data transfer from your camera to a computer, etc. is not possible due to a malfunction of your camera or recording medium (SD Memory Card), etc.
- The lens on this camera is not exchangeable. The lens is not removable.
- Do not clean the product with organic solvents such as thinner, alcohol or benzene.
- Places of high temperature and humidity should be avoided. Particular care should be taken regarding vehicles, which can become very hot inside.
- Storing the camera where pesticides and chemicals are handled should be avoided. Remove the camera from its case and store in a well-ventilated place to prevent the camera from becoming moldy during storage.
- Do not use the camera where it may come in contact with rain, water or any other liquid, because the camera is not weather, water, or liquid resistant.
- Ensure that the camera is not subjected to substantial vibrations, shocks or pressure. Place the camera on a cushion for protection when the camera is subjected to the vibrations of a motorbike, car, or ship, etc.
- The temperature range in which the camera can be used is 0°C to 40°C (32°F to 104°F).
- The liquid crystal display will become black at high temperature but will return to normal when normal temperatures are returned to.
- The response speed of the liquid crystal display becomes slow at low temperatures. This is due to the properties of the liquid crystal and is not a fault.
- Periodic checks are recommended every 1 to 2 years in order to maintain high-performance.

- If the camera is subjected to rapid temperature changes, condensation may form on the inside and outside of the camera.
Therefore put the camera in a bag or plastic bag, and take the camera out when the difference in temperature has subsided.
- Avoid contact with garbage, dirt, sand, dust, water, toxic gases, salt, etc. as this may cause damage to the camera. If rain or drops of water get onto the camera, please wipe dry.
- Refer to “Precautions When Using an SD Memory Card” (p.25) regarding the SD Memory Card.
- Please note that the formatting of the SD Memory Card or built-in memory will delete all data, however it may still be possible to recover that data using off-the-shelf data recovery software. Please manage your camera’s memory at your own risk.
- The AC plug cord supplied with the camera is for exclusive use with the Battery charger D-BC8. Do not use it with any other equipment.
- Please do not press forcefully on the LCD monitor. This could cause breakage or malfunction.
- Be careful not to sit down with the camera in your back pocket as this may damage the exterior of the camera or the LCD monitor.
- When using a tripod with the camera, be careful not to overtighten the screw in the tripod socket on the camera.

LED Safety Standard

This device is a digital still camera that conforms to the safety standard (IEC60825-1) for a Class 1 LED product.

Regarding Product Registration

To better serve you, we request that you complete the product registration, which can be found on the CD-ROM supplied with the camera or the PENTAX website.

Thank you for your cooperation.

Refer to the PC Connection Manual (bottom right of front side) for more information.

Contents

Using your camera safely	1
Care to be Taken During Handling	4
Contents of the Operating Manual	9
Quick Lessons in Mastering the Camera	10
Checking the Contents of the Package	12
Names of Parts	13
Names of Operating Parts	14
Getting Started	15
Attaching the Strap	15
Powering the Camera	16
Installing the Battery	16
Removing the Battery	16
Charging the Battery	17
Charging the Battery Abroad	19
Using the AC Adapter (optional)	21
Installing the SD Memory Card	23
Image Size and Quality of Still Pictures	26
Size and Quality of Movies	27
Initial Settings (Setting the Display Language and the Date and Time)	29
Setting the Display Language	29
Setting the Date and Time	30
Quick Start	33
Taking Still Pictures	33
Playing Back Still Pictures	37
Playing Back an Image	37
Playing Back the Previous or Next Image	37
Common Operations	39
Turning the Camera On and Off	39
Turning the Camera On in Capture Mode	39
Turning the Camera On in Playback Mode	40
Using the Button Functions	41
Capture Mode	41
Playback Mode	42
Voice Recording Mode	44
Setting the Menus	45
How to Set the Menus	45
Menu List	48
Operating the Mode Palette	50
How to operate the Mode Palette	50
Taking Pictures	53
Taking Pictures	53
Changing the Mode	53
Selecting the Capture Mode	53
Displaying Shooting Information in Capture Mode	53
Taking Pictures Using the Shake Reduction Function	57
Taking Pictures in the Basic Mode (Green Mode)	59
Taking Pictures Automatically (Auto Picture Mode)	61
Using the Exposure Mode and Other Functions	63
Selecting the Picture Mode According to the Shooting Scene (Picture Mode) ..	67

Taking Pictures of Dark Scenes (Night Scene Mode).....	77
Reducing Camera Shake and Blurring in Pictures (Digital SR Mode)	78
Taking Movies (Movie Mode).....	79
Taking Pictures in Frame Composite mode.....	81
Using the Self-timer	83
Continuous Shooting (Continuous Shooting Mode).....	84
Shooting in Multi-exposure Mode	85
Using the Remote Control Unit (optional)	86
Using Zoom to Change the Subject Size	88
Setting the Shooting Functions	90
Selecting the Focus Mode	90
Selecting the Flash Mode	93
Selecting the Recorded Pixels of Still Pictures	95
Selecting the Quality Level of Still Pictures.....	97
Adjusting the White Balance	98
Selecting the Autofocus Settings	100
Setting the Light Metering Mode to Determine the Exposure	103
Setting the Sensitivity.....	104
Setting the Exposure (EV Compensation)	106
Selecting the Settings for Taking Movies.....	107
Setting the Shake Reduction Function for Still Images to On	110
Setting the Instant Review Time	111
Setting the Face Priority to On	112
Setting the D-Range Compensation	113
Setting the One push PF function to On	114
Setting the Green Button	115
Setting the Image Sharpness.....	118
Setting the Color Saturation.....	119
Setting the Image Contrast	120
Setting the Date Imprint	121
Saving the Settings	122
Saving the Menu Items (Memory).....	122
Recording and Playback of Sound	124
Recording Sound (Voice Recording Mode)	124
Playing Back Sound.....	126
Adding a Voice Memo.....	127
Recording a Voice Memo.....	127
Playing Back a Voice Memo	128
Playback/Deleting/Editing	129
Playing Back Images.....	129
Playing Back Still Pictures	129
Zoom Display	129
Calling Up the Images from the Built-in Memory	130
Playing Back Movies.....	131
Displaying Shooting Information in Playback Mode.....	132
Nine-Image Display/Calendar Display	133
Slideshow.....	135
Deleting Images, Movies and Sounds	137
Deleting a Single Image, Movie or Sound.....	137
Deleting All Images, Movies or Sound Files	139
Deleting Selected Images and Sound Files (from Nine-Image Display).....	140
Protecting Images, Movies and Sounds from Deletion (Protect)	142
Viewing Images on AV Equipment	144

Playing Back an Image Using the Remote Control Unit (optional)	145
Setting the Printing Service (DPOF)	146
Printing Single Images	146
Printing All Images	148
Direct Printing Using PictBridge.....	149
Connecting the Camera to the Printer	149
Printing Single Images	150
Printing All Images	151
Printing Using the DPOF Settings.....	152
Disconnecting the Camera from the Printer	152
Editing Images	153
Changing the Image Size and Quality	153
Cropping Images.....	155
Rotating the Displayed Image.....	156
Editing Pictures with Color Filters	157
Editing Pictures with the Digital Filter.....	159
Editing Pictures with Brightness Filter.....	161
Editing Movies.....	163
Removing Red-eye	166
Adding a Frame (Frame Composite)	168
Copying Files.....	170
Settings	172
<hr/>	
Camera Settings	172
Setting Up the Start-up Screen	172
Formatting an SD Memory Card or the Built-in Memory	174
Changing the Sound Settings	175
Changing the Date and Time	178
Setting the World Time	180
Changing the Display Language.....	182
Changing the Image Folder Name	183
Changing the USB Connection Mode	184
Changing the Video Output Format	185
Adjusting the Brightness of the LCD Monitor	186
Setting Power Saving.....	187
Setting Auto Power Off	188
Setting the Guide Display	189
Resetting to Default Settings	189
Appendix	190
<hr/>	
List of Cities.....	190
Default Settings	191
Optional Accessories.....	196
Messages	197
Troubleshooting	199
Main Specifications	201
WARRANTY POLICY	204
Index	209

Contents of the Operating Manual

This operating manual contains the following chapters.

1 Getting Started

This chapter explains what you need to do after purchasing the camera before you start taking pictures. Be sure to read it and follow the instructions.

2 Quick Start

This chapter explains the simplest way to take pictures and play back images. Use it if you want to start taking pictures straightaway.

3 Common Operations

This chapter explains common operations such as the functions of the buttons and how to use the menus. For more details, refer to the respective "Taking Pictures", "Recording and Playback of Sound", "Playback/Deleting/Editing" and "Settings" chapters.

4 Taking Pictures

This chapter explains the various way of capturing images and how to set the relevant functions, including how to use the Capture Mode screen to select the capture mode best suited to the situation.

5 Recording and Playback of Sound

This chapter explains how to record sound only or add a voice memo to an image, and how to play back voice memos.

6 Playback/Deleting/Editing

This chapter explains how to play back images on the camera or on a TV, how to delete, resize and crop images, and how to print images directly to the printer.



7 Settings

This chapter explains how to set the camera-related functions.

8 Appendix

This tells you about the messages displayed on the LCD monitor and what to do in the event of trouble.

The meanings of the symbols used in this operating manual are explained below.

	indicates the reference page number for an explanation of the related operation.
	indicates information that is useful to know.
	indicates precautions to be taken when operating the camera.

1

2

3

4

5

6

7

8

Quick Lessons in Mastering the Camera

If you wish to master the camera quickly after purchasing the **Optio A40** Go through all the basic operations from preparation, photo-taking and reviewing as shown below. (For the operating instructions, see the pages in parenthesis.)

Check the package. (p.12)



Prepare the camera.

Attach the strap. (p.15)

Power the camera.

Charge (p.17) and install the battery. (p.16)

Install the SD Memory Card. (p.23)

Make the initial settings. (p.29-32)



Let's get used to the basic operations.

Turn the camera on and off. (p.39)

Take still pictures. (p.33-36)

Play back and delete the pictures. (p.37-38)

Switch between Capture mode and Playback mode.

(p.53)

Mastering the shutter release is the key to taking good pictures.



Let's take pictures in the Basic mode. (p.59-60)



This is the easiest way to take pictures.

Let's use the menus.

Set menu items. (p.45-46)
Select the recorded pixels and quality level for still pictures. (p.95-97)



Just by selecting icons, you can activate desired modes for image capture or editing.

Let's use the Mode Palettes.

Select icons on the Mode Palettes. (p.50-52)



Let's select a mode for capturing images.

Auto Picture Mode (p.61)
Picture modes (p.67-76)



Let's use shooting functions.

Self-timer (p.83)
Zoom (p.88)
Flash (p.93)
Shake Reduction (p.57)

For availability of functions for each Capture Mode, see p.194.



Let's enjoy reviewing the pictures you took.

Zoom display, nine-image display, and calendar display (p.129-134)
Slideshow (p.135)



Once you get used to the basic operations, enjoy taking movies, editing pictures, or printing your favorite pictures.

Checking the Contents of the Package



Camera
Optio A40

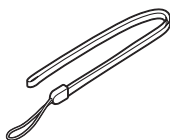

Strap
O-ST20 (*)

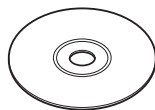

Software (CD-ROM)
S-SW68

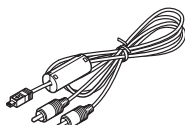

AV cable
I-AVC7 (*)

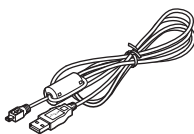

USB cable
I-USB7 (*)



Rechargeable
lithium-ion battery
D-LI8 (*)

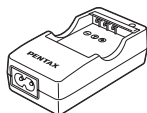

Battery charger
D-BC8 (*)



AC plug cord



Operating Manual
(this manual)

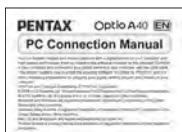

Operating Manual
(PC Connection Manual)



Quick Guide

Items marked with an asterisk (*) are also available as optional accessories. The Battery Charger D-BC8 is only available as a kit including the AC plug cord and is not sold as a separate item. For details on the optional accessories, refer to “Optional Accessories” (p.196).

Names of Parts

Front

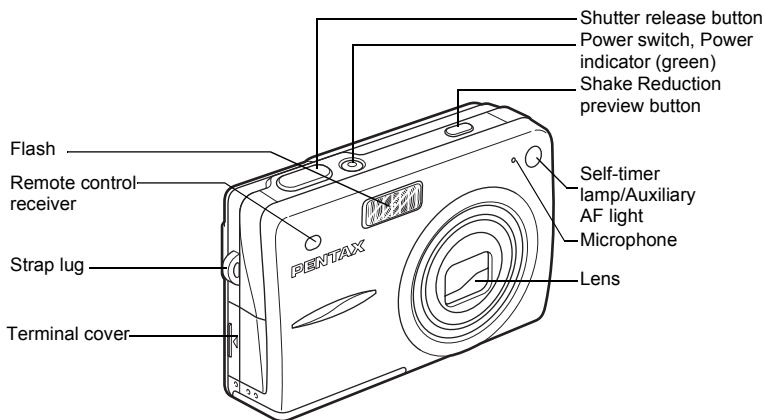

Back

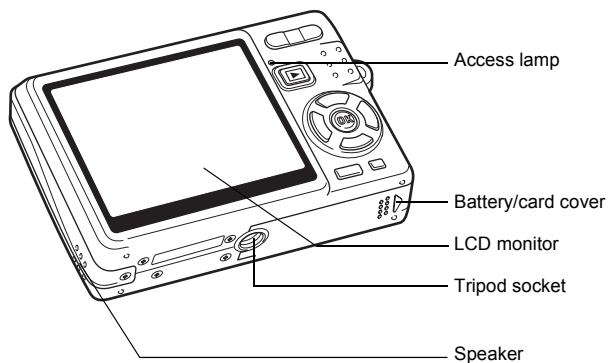

Names of Operating Parts

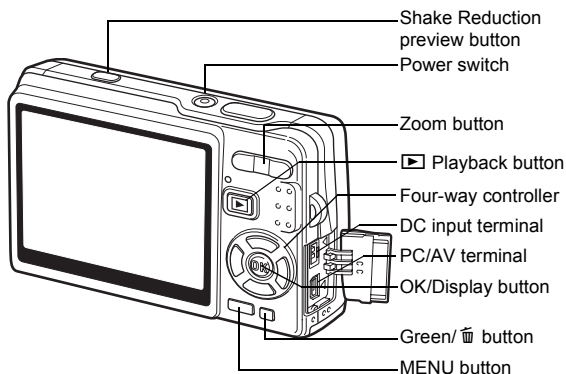

Four-way controller

In this operating manual, the four-way controller is described as shown below.

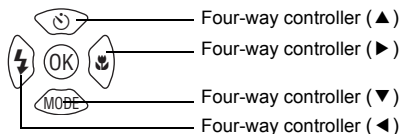

Button operation guide

The button operation guide appears at the bottom of the LCD monitor during operation.

The buttons are indicated as shown below.

Four-way controller (▲)	▲
Four-way controller (▼)	▼
Four-way controller (◀)	◀
Four-way controller (▶)	▶
MENU button	
Shutter release button	
OK button	

Zoom button	
for cropping images or removing Red-eye	
Green/🗑️ button	
for operating as the Green button	
for deleting an image	

Attaching the Strap

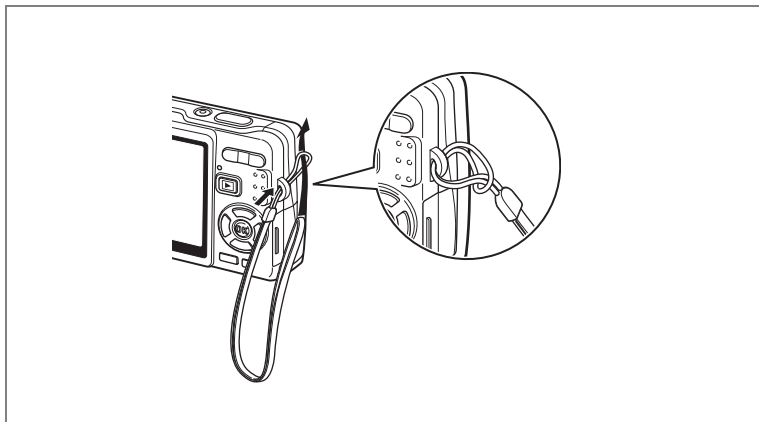

Pass the narrow end of the strap through the strap lug and pass the other end through the loop on the end of the strap.

Powering the Camera

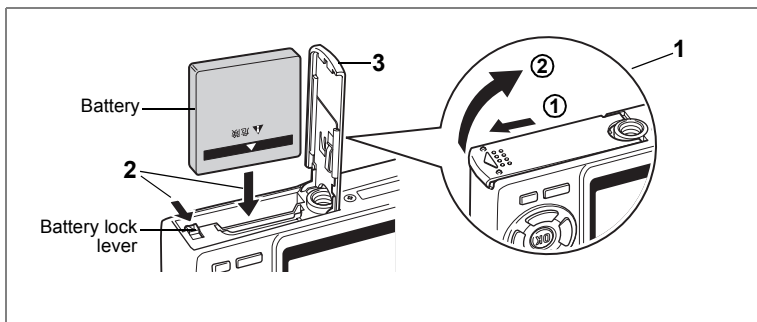

Installing the Battery

Install the battery provided with the camera.

- 1 Open the battery/card cover.**
Slide the battery/card cover in the direction ①. The cover will automatically open in the direction ② when you release your fingers from the cover.
- 2 Insert the battery with the ▲ symbol facing toward the LCD monitor while using the side of the battery to press the battery lock lever in the direction indicated by the arrow.**
- 3 Close the battery/card cover.**

Removing the Battery

- 1 Open the battery/card cover.**
- 2 Release the battery by using your finger to press the battery lock lever in the same direction as when you inserted the battery.**

The battery will be ejected. Pull the battery out of the camera.



If you intend to use the camera continuously for a long period, use of the AC adapter kit K-AC63 (optional) is recommended. (p.21)



- Insert the battery correctly. If the battery is incorrectly oriented, it may cause a malfunction.
- Do not remove the battery when the camera is turned on.
- If you do not intend to use the camera for a long time, remove the battery.
- If the camera is left without the battery for a long time, the date may be reset.

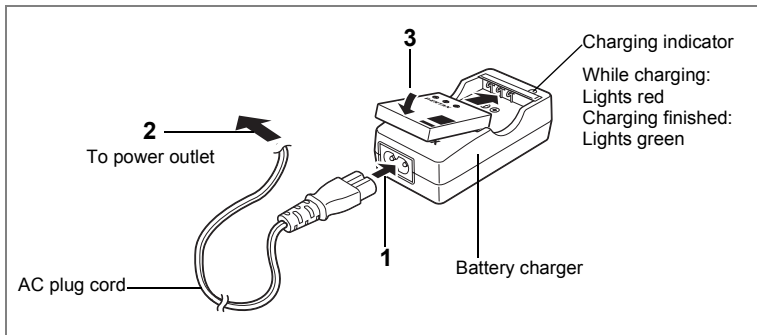

Charging the Battery

Use the battery charger to charge the battery before installing it in the camera for the first time or after a long period of non-use, or when the message [Battery depleted] appears.

Note: AC plug cord “Listed, Type SPT-2 or NISPT-2, 18/2 flexible cord, rated 125 V, 7A, minimum 6ft (1.8m)”

- 1** Connect the AC plug cord to the battery charger D-BC8.
- 2** Plug the AC plug cord into the power outlet.
- 3** Place the battery in the charger so that the **PENTAX logo is visible**.
The charging indicator lights red while the battery is charging and Lights green when charging is finished.
- 4** Remove the battery from the battery charger when charging is finished.



- The time required to fully charge the battery is about 100 minutes (max.). The appropriate ambient temperature for charging the battery is 0°C to 40°C (32°F to 104°F). (The charging time may vary depending on the ambient temperature and charging conditions.)
- It is recommended you charge the battery on the day or the day before you use the camera.
- The battery has reached the end of its service life if it runs down soon after being charged. Replace with a new battery.

Caution

- Do not use the battery charger D-BC8 to charge batteries other than D-LI8 rechargeable lithium-ion batteries, as the charger may overheat or be damaged.
 - If the battery is inserted correctly but the charging indicator fails to light, the battery may be faulty. Replace it with a new battery.
 - Storing the battery with full charge may cause battery performance to deteriorate. Do not store batteries especially in places of high temperature.
- When the battery is left within the camera for a long time, small amount of electrical current will flow and cause the battery to over-discharge. This causes battery life to become short.

• Approximate Operating Time (when the D-LI8 battery is fully charged)

Number of recordable images : Approx. 180 (at 23°C with the LCD monitor on and the flash used for 50% of shots)*1

Playback time : Approx. 200 min.*2

Movie recording time : Approx. 70 min.*2

Sound recording time : Approx. 180 min.*2

*1 The number of recordable images is based on CIPA standard measurement and may vary depending on capture mode and shooting conditions.





*2 Measured based on PENTAX standard and may vary depending on the condition of use.

Caution

- In general, battery performance temporarily deteriorates as the temperature decreases. When using the camera in a cold environment, keep it warm by putting it in your pocket or inside your coat. Battery performance that has deteriorated due to low temperature will be restored when the battery is returned to room temperature.
- Be sure to take a spare battery with you when traveling abroad or to a cold region, or if you intend to take a lot of pictures.

• **Battery Level Indicator**

You can check the battery level by the  symbol on the LCD monitor.

	(lit green) : Adequate power remains.
↓	
	(lit green) : Battery is running low.
↓	
	(lit yellow) : Battery is running very low.
↓	
	(lit red) : Battery is exhausted.
↓	
[Battery depleted] : The camera will turn off after the message appears.	

Charging the Battery Abroad









The battery charger supplied with the camera is designed to switch automatically to the voltage (100-240V) and frequency (50Hz, 60Hz) of the electricity supply in the country or region where used.

However, electrical socket shapes differ depending on the country or region. Before traveling abroad, you are advised to check the socket shape in your destination (see “Main Socket Types in the Major Countries and Regions of the World” (p.20)) and take an appropriately shaped off-the-shelf adapter plug with you. (Electrical socket shapes may vary depending on every region in the country. Check the socket shape used in the region.)

The socket shape does not affect the charging method.

Caution

- Use of an off-the-shelf transformer may lead to defective operation.
- Unplug the adapter plug from the power outlet when the battery charger is not in use.

Type	A	B	BF	C	S
Shape					
Adapter plug	—				

Main Socket Types in the Major Countries and Regions of the World

1

Getting Started

		A	B	BF	C	S
North America	U.S.A., Canada	✓				
Europe, Former Soviet Union	Iceland, Ireland, Italy, Ukraine, Austria, Netherlands, Kazakhstan, Greece, Sweden, Denmark, Germany, Norway, Hungary, Finland, France, Belarus, Belgium, Rumania, Russia				✓	
	U.K.		✓	✓		
	Spain	✓			✓	
	Switzerland, Poland, Portugal		✓		✓	
Asia	Taiwan, Japan	✓				
	Sri Lanka, Maldives		✓			
	Nepal, Bangladesh, Mongolia				✓	
	Vietnam	✓			✓	
	India, Indonesia, Pakistan, Macau		✓		✓	
	Thailand	✓		✓	✓	
	Korea	✓	✓		✓	
	Philippines	✓			✓	✓
	Singapore, Hong Kong		✓	✓		
	China	✓	✓	✓	✓	✓
Malaysia		✓	✓	✓		
Oceania	Australia, Tonga, New Zealand, Fiji					✓
	Guam	✓				
	Tahiti				✓	
Central and South America	Colombia, Jamaica, Haiti, Panama, Bahamas, Puerto Rico, Venezuela, Mexico	✓				
	Brazil, Peru	✓			✓	
	Chile		✓		✓	
	Argentina			✓	✓	✓
Middle East	Israel, Iran				✓	
	Kuwait		✓		✓	
	Jordan		✓	✓		
Africa	Canary Islands, Guinea, Mozambique, Morocco				✓	
	Kenya, South Africa		✓		✓	
	Algeria	✓	✓	✓		
	Egypt		✓	✓	✓	
	Zambia, Tanzania		✓	✓		

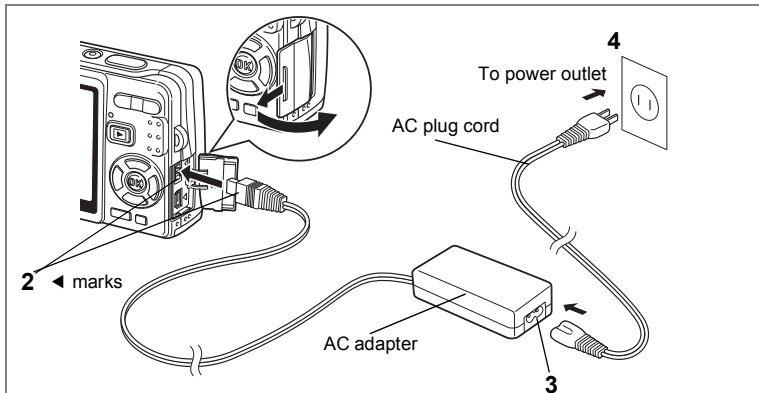

Using the AC Adapter (optional)

If you intend to use the LCD monitor for a long time or connect the camera to a PC, use of the AC adapter kit K-AC63 (optional) is recommended.

- 1** Make sure that the camera is turned off and open the terminal cover.
- 2** Connect the DC terminal on the AC adapter to the DC input terminal on the camera, being sure to match the ◀ marks.
- 3** Connect the AC plug cord to the AC adapter.
- 4** Plug the AC plug cord into the power outlet.



- Make sure that the camera is turned off when connecting or disconnecting the AC adapter.
- Make sure that the AC plug cord and connecting cable are inserted securely. The data may be lost if the cable becomes disconnected while you are taking pictures.
- Be sure to read the operating manual accompanying the AC adapter before using the adapter.
- Be sure to match the ◀ marks when connecting the DC terminals. Inserting the plugs with too much force may damage them.

Precautions When Using the Battery Charger or AC Adapter

To avoid the risk of fire or electric shock when using the battery charger or AC adapter, be sure to read the section on “Using your camera safely” on page 1.

1

Installing the SD Memory Card

1

Getting Started

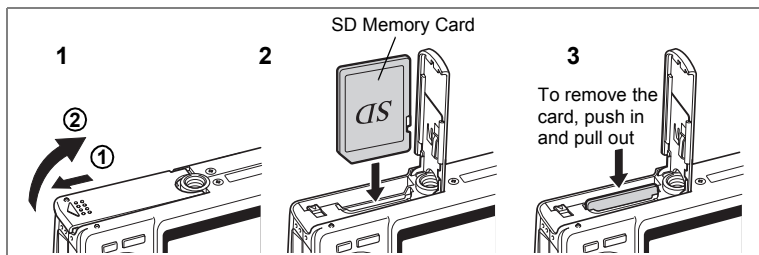

You can use an SD (and SDHC) Memory Card with this camera. Images are recorded on the SD Memory Card or in the built-in memory of the camera.

When shooting with an SD Memory Card installed

☐ appears in the upper right corner of the LCD monitor and the images are recorded on the card.

When shooting with no SD Memory Card installed

☒ appears in the upper right corner of the LCD monitor and the images are recorded in the built-in memory.



- Make sure that the camera is turned off before inserting or removing the SD Memory Card.
- Be sure to format unused cards or cards that have been used in another camera. Refer to “Formatting an SD Memory Card or the Built-in Memory” (p.174) for instructions on formatting.

1 Open the battery/card cover.

Slide the battery/card cover in the direction ①. The cover will automatically open in the direction ② when you release your fingers from the cover.

2 Insert an SD Memory Card so the label (the side with the ▲ symbol) is facing toward the LCD monitor and push the card in until it clicks.

3 Close the battery/card cover.

To remove the card, eject the card by pressing it in the direction indicated by the arrow and pull it out.



- The number of recordable images varies depending on the capacity of the SD Memory Card or built-in memory, the selected image size and quality. (☞ p.26)
- If you store your favorite images and sounds in the built-in memory, you can play them back whenever you wish (My album function). (☞ p.130)

Data Backup

Very occasionally, data stored in the built-in memory becomes unreadable. As a backup measure, we recommend that you transfer important data to a PC or store the data in a medium other than the built-in memory.

Precautions When Using an SD Memory Card

- Make sure that the camera is turned off before opening the battery/card cover.
 - The SD Memory Card is equipped with a write-protect switch. Setting the switch to [LOCK] protects the existing data by prohibiting recording of new data, deletion of existing data or formatting of the card. Write-protect switch
- 
- Care should be taken if you remove the SD Memory Card immediately after using the camera, as the card may be hot.
 - Do not remove the SD Memory Card or turn the camera off while data is being recorded on the card, images or sound are being played back, or the camera is connected to a PC with the USB cable as this may cause the data to be lost or the card to be damaged.
 - Do not bend the SD Memory Card or subject it to violent impact. Keep it away from water and store away from high temperature.
 - Be sure to format unused cards or cards that have been used in another camera. Refer to "Formatting an SD Memory Card or the Built-in Memory" (p.174) for instructions on formatting.
 - Do not remove the SD Memory Card during formatting as this may damage the card and render it unusable.
 - The data on the SD Memory Card may be deleted in the following circumstances. PENTAX does not accept any liability for data that is deleted
 - (1) when the SD Memory Card is mishandled by the user.
 - (2) when the SD Memory Card is exposed to static electricity or electrical interference.
 - (3) when the card has not been used for a long time.
 - (4) when the card is ejected, the AC adapter is disconnected or the battery is removed while the data on the card is being recorded or accessed.
 - If an SD Memory Card is not used for a long time, the data on the card may become unreadable. Be sure to regularly make a backup of important data on a PC.
 - Avoid using or storing the card where it may be exposed to static electricity or electrical interference.
 - Avoid using or storing the card in direct sunlight or where it may be exposed to rapid changes in temperature or to condensation.
 - When using an SD Memory Card with a slow recording speed, recording may stop while you are taking movies even when there is adequate space in the memory, or shooting and playback may take a long time.
 - Before purchasing an SD Memory Card, please visit the PENTAX website to ensure that it is compatible with your camera.
 - If you are going to discard, give away or sell your SD Memory Card, you should ensure that the data on the card is completely deleted or the card itself is destroyed if it contains any personal or sensitive information. Please note that formatting the SD Memory Card will not necessarily delete the data so that it cannot be recovered using off-the-shelf data recovery software. There are off-the-shelf secure data deletion software programs available that will completely delete the data. In any case, the data on your SD Memory Card should be managed at your own risk.

Image Size and Quality of Still Pictures

Select the image size and quality best suited to your purpose. Higher quality levels and numbers of recorded pixels produce clearer images for printing, but the resulting increase in file size reduces the total number of pictures that can be taken.

When you select high image quality as well as a large image size, it may take ten seconds or more for the camera to finish recording after shooting.

Select the appropriate number of recorded pixels and quality level on the [📷 Rec. Mode] menu.

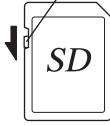
How to Set the Menu 📖p.45

Selecting the Recorded Pixels of Still Pictures 📖p.95

Selecting the Quality Level of Still Pictures 📖p.97

● Appropriate Sizes According to Use

12M (4000×3000)	↑ Clear, Fine	For printing images with high-resolution settings in your printer, printing at A4 size or larger, or editing and processing images
10M (3648×2736)		
7M (3072×2304)		For printing at postcard size For using as images on websites, or attaching images to e-mails
5M (2592×1944)		
3M (2048×1536)		
1024 (1024×768)		
640 (640×480)		

The default setting is **12M (4000×3000)**.

● Appropriate Quality According to Use

★★★	Best	Lowest compression ratio. Suitable for large A4-size photo prints.
★★	Better	Standard compression ratio. Suitable for photo prints or viewing images on a computer screen.
★	Good	Highest compression ratio. Suitable for attaching to e-mails or creating websites.

The default setting is **★★**.

● Approximate Number of Recordable Images by Size and Quality

Quality Level Recorded Pixels	★★★ Best	★★ Better	★ Good	Sound
12M (4000×3000)	201	291	404	17 hr. 11 min. 28 sec.
10M (3648×2736)	242	350	486	
7M (3072×2304)	342	495	685	
5M (2592×1944)	481	695	963	
3M (2048×1536)	728	1053	1458	
1024 (1024×768)	1856	2682	3714	
640 (640×480)	3405	4918	6811	

- The table above indicates the approximate number of images and recording time when using a 1GB SD Memory Card.
- The table above is based on standard shooting conditions specified by PENTAX and may vary depending on the subject, shooting conditions, capture mode, SD Memory Card, etc.

Size and Quality of Movies

Select the size and quality best suited to your purpose.

The larger size and the higher quality level ★ are selected, the clearer moving images are produced, but the file size is increased.

Select the appropriate size and quality on the [📷 Rec. Mode] menu.

Selecting the Recorded Pixels of Movies p.107

Selecting the Quality Level of Movies p.108

● Appropriate Sizes (Recorded Pixels) According to Use

640 (640×480)	Viewing high-quality movies at VGA size. The recordable time is shorter.
320 (320×240)	Smaller file size allows a longer time recording.

The default setting is **640 (640×480)**.

● Approximate Recordable Time by Size (Recorded Pixels) and Quality

Quality Level Recorded Pixels	★★★ Best	★★ Better	★ Good
640 (640×480)	46 min. 0 sec.	57 min. 38 sec.	69 min. 11 sec.
320 (320×240)	177 min. 56 sec.	221 min. 3 sec.	254 min. 52 sec.

The default setting is ★★★.

- The table above indicates the approximate recording times when using a 1GB SD Memory Card.
- The table above is based on standard shooting conditions specified by PENTAX and may vary depending on the subject, shooting conditions, capture mode, SD Memory Card, etc.

Initial Settings (Setting the Display Language and the Date and Time)

1

Getting Started

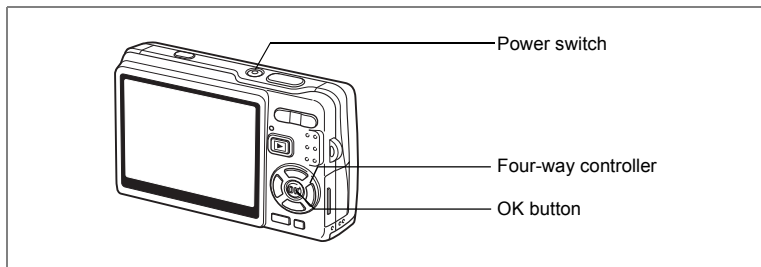

If the Initial Setting screen or Date Adjust screen appears when you turn the camera on, follow the procedure below to set the display language and/or current date and time.

If the Initial Setting screen appears:

⇒ p.29 - 30 “Setting the Display Language”, “Setting the Date and Time”

If the Date Adjust screen appears:

⇒ p.30 - 31 “Setting the Date and Time”

If you want to change the initial settings, refer to “Changing the Date and Time” (p.178) and “Changing the Display Language” (p.182).

Setting the Display Language

You can select the language in which the menus and error messages are displayed from the following: [English], [French], [German], [Spanish], [Portuguese], [Italian], [Dutch], [Danish], [Swedish], [Finnish], [Polish], [Czech], [Hungarian], [Turkish], [Russian], [Thai], [Korean], [Chinese (traditional and simplified)] and [Japanese].

1 Press the four-way controller (►).

The Language/言語 screen appears.

2 Use the four-way controller (▲▼◀▶) to select a language.

The default setting is English.

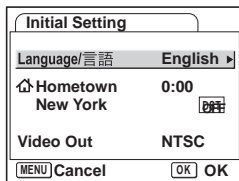

29

3 Press the OK button.

4 Press the four-way controller (▼).

The frame moves to [↕].

5 Use the four-way controller (◀▶) to select the desired city (Hometown).

6 Press the four-way controller (▼).

The frame moves to [DST] (Daylight Saving Time).

7 Use the four-way controller (◀▶) to select [(On) / (Off)].

8 Press the OK button.

The Date Adjust screen appears.

Setting the Date and Time

Set the current date and time and the display style.

1 Press the four-way controller (▶).

The frame moves to [mm/dd/yy].

2 Use the four-way controller (▲▼) to select the date display style.

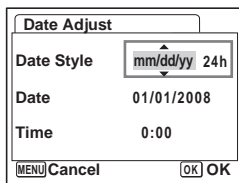

3 Press the four-way controller (▶).

The frame moves to [24h].

4 Use the four-way controller (▲▼) to select [24h] (24-hour display) or [12h] (12-hour display).

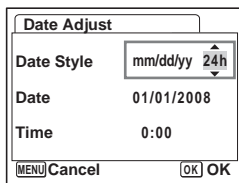

5 Press the four-way controller (▶).

The frame returns to [Date Style].

6 Press the four-way controller (▼).

The frame moves to [Date].

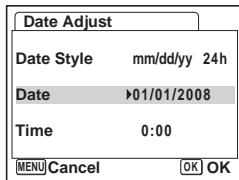

7 Press the four-way controller (▶).

The frame moves to the month.

8 Use the four-way controller (▲▼) to change the month.

Change the day and year in the same manner.

Next, change the time.

If you have selected [12h] in Step 4, the setting switches between am and pm corresponding to the time.

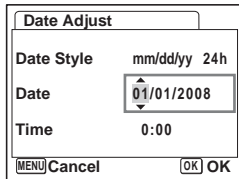

- When you finish the settings and press the OK button, the camera clock is reset to 00 seconds.
- To set the exact time, press the OK button when the time signal (on the TV, radio, etc.) reaches 00 seconds.

- You can cancel the settings for the Initial Setting by pressing the MENU button. If you take pictures without completing the Initial Setting, the Initial Setting screen will appear next time you turn on the camera.
- You can change your settings for the Initial Setting later using the [X↓ Set-up] menu.
Language: “Changing the Display Language” (p.182)
City, Daylight saving time: “Setting the World Time” (p.180)
Date and Time: “Changing the Date and Time” (p.178)
- The video output format is automatically set according to the language you have selected. If the output format is different from the one used in your country or region, change the format following the procedures described in “Changing the Video Output Format” (p.185).

Language	Video Output Format
English (English)	NTSC
French (Français)	PAL
German (Deutsch)	PAL
Spanish (Español)	PAL
Portuguese (Português)	PAL
Italian (Italiano)	PAL
Netherlands (Nederlands)	PAL
Danish (Dansk)	PAL
Swedish (Svenska)	PAL
Finnish (Finnish)	PAL
Polish (Polish)	PAL
Czech (Czech)	PAL
Hungarian (Hungarian)	PAL
Turkish (Türkçe)	PAL
Russian (Русский)	PAL
Thai (ไทย)	PAL
Korean (한국어)	NTSC
Chinese (traditional) (中文繁體)	PAL
Chinese (simplified) (中文简体)	PAL
Japanese	NTSC

Taking Still Pictures

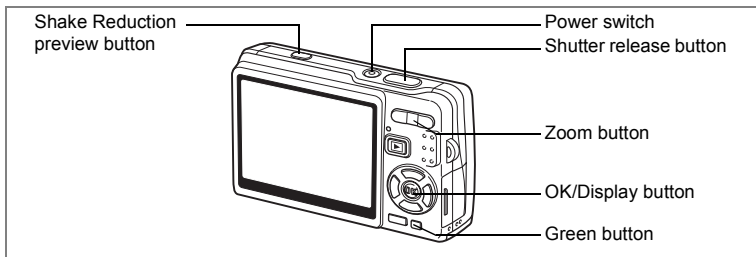

The simplest procedure for taking still pictures is described below. The flash discharges automatically depending on the light conditions.

1 Press the power switch.

The camera turns on.

2 Compose the picture on the LCD monitor.

The camera AF will focus on the area within the focus frame.

Press the zoom button to change the size of the subject.

Zoom button (♦) : Enlarges the subject.

Zoom button (♦♦♦) : Diminishes the subject.

While the Face Priority is set to On, a yellow focus frame appears on the subject's face when the camera recognizes it. The position and the size of the frame change while the camera continues to adjust the focus on the moving subject.



Focus frame

3 Press the shutter release button halfway.

The focus frame on the LCD monitor will light green when the camera is in focus.

When [Shake Reduction] is set to [On], (Shake Reduction On) appears on the LCD monitor. To take the picture compensating for camera shake, go to step 4 after (Shake Reduction On) is displayed.

4 Press the shutter release button fully.

The picture is taken.

The image appears on the LCD monitor for 0.5 seconds (Instant Review). The image is recorded on the SD Memory Card installed in the camera, or in the built-in memory of the camera.

Pressing the shutter release button

Press the shutter release button slowly in two steps. This allows for exact focusing as well as preventing camera shake.

Basic way of shutter release

1 Press the shutter release button halfway.

Lightly press the shutter release button until you feel the click on your finger.

2 Confirm the focus frame on the LCD monitor turns green.

Hold the shutter release button and wait until the focus frame turns green. The camera is in focus.

3 Press the shutter release button fully.

Press it down slowly until the shutter is released.

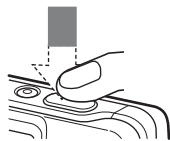

↓
The camera is in focus.

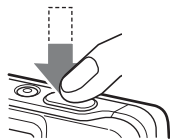

↓
The picture is taken.



You can press the shutter release button all the way down (single step) when Focus Mode is set to Standard (Autofocus) and One push PF in the [📷 Rec.Mode] menu is set to On. (p.114)

This allows you to release the shutter at the right moment. The pictures are taken as deep-focus (pan focus) shots.

Focus lock

When you have difficulty in auto focusing on a subject, try the procedures below.

You may have difficulty in auto focusing on such subjects as:

- Subject contrast is very low. (a blue sky, solid white walls, etc.)
- Dark places, black objects, or subjects that cannot reflect light.
- Areas of strongly reflected light or backlit subjects
- Fine patterns
- Rapidly moving objects
- When a distant object and a close object are both in the focus frame.

- 1 Find an alternate subject placed at the same distance from the camera as the desired subject.**
- 2 Focus on the alternate subject.**
Locate it in the focus frame on the LCD monitor.
- 3 Press the shutter release button halfway.**
The focus frame turns green when the camera is in focus.
- 4 While holding the shutter release button halfway, move the camera to obtain the desired composition.**
The focus is locked at the point you set in step 3 even if you recompose. (Focus lock)
- 5 Press the shutter release button fully.**

Instant Review

By default, the image is displayed on the LCD monitor for 0.5 seconds right after shooting (Instant Review). You can change the display time for the Instant Review. (☞ p.111)

If you set it longer, you can delete the image while it is displayed on the LCD monitor.

1 Press the Green/  button while the image is displayed.

The screen for deleting the image appears.

2 Press the four-way controller (▲) to select [Delete] and press the OK button.

The image displayed on the LCD monitor is deleted.

Brightening the LCD Backlight

You can temporarily brighten the LCD backlight to improve viewing. (LCD Bright Mode)

It is useful when you view the LCD monitor outdoors or in brighter places.

1 In Capture mode, press and hold the OK/Display button for more than 1 second.

The LCD monitor turns brighter for a certain amount of time.



You can cancel the function by doing either of the followings.

- Switch the display mode to LCD Backlight Off. (☞ p.54)
- Turn off the camera.

Playing Back Still Pictures

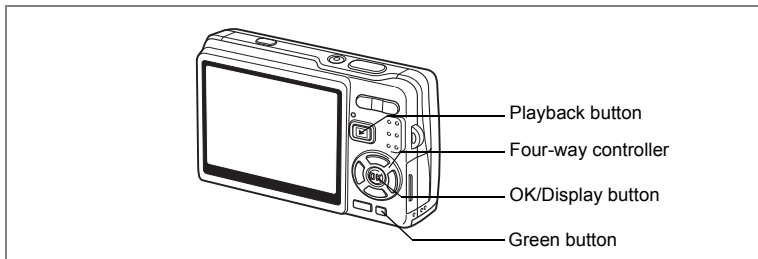

Playing Back an Image

You can display the still picture you have just taken.

- 1 Press the  Playback button after taking a picture.**

The image appears on the LCD monitor. When you press and hold the OK/Display button for more than 1 second, the LCD Bright Mode is activated. The LCD monitor turns brighter for a certain amount of time.



Zoom Display  p.129

Playing Back the Previous or Next Image

Still pictures can be played back one at a time, proceeding either forward or backward.

- 1 Press the  Playback button after taking a picture.**

The image appears on the LCD monitor.

- 2 Press the four-way controller ( ).**

Four-way controller (): Displays the previous image.

Four-way controller (): Displays the next image.

Deleting the Displayed Image

1 Press the Green/ button when playing back an image.

The screen for deleting the image appears.

2 Press the four-way controller () to select [Delete] and press the OK button.

The image displayed on the LCD monitor is deleted.



3 Press the Playback button again or press the shutter release button halfway.

The camera is ready for taking pictures.

You can press the shutter release button halfway to return to the Capture mode.



- The last picture taken appears on the LCD monitor when you switch to the Playback mode.
- You can enlarge the image displayed on the LCD monitor by pressing the zoom button. (If you press the zoom button to enlarge a rotated image, the enlarged image will return to its original position. If you stop enlarging the image, the image will be rotated again.)
- If there is no image stored, the message [No image/sound] appears.

Zoom Display  p.129

Deleting a Single Image, Movie or Sound  p.137

Turning the Camera On and Off

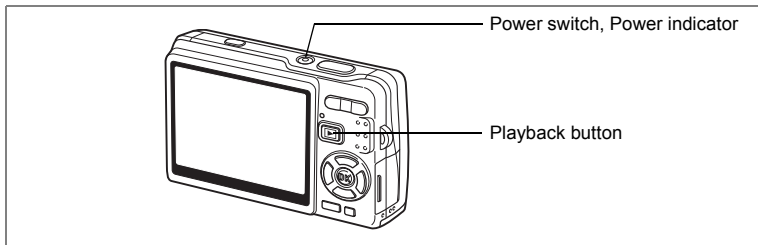



Turning the Camera On in Capture Mode

1 Press the power switch.

The power indicator lights up in green. The lens extends and the camera turns on in the "Capture mode". The camera is ready for taking pictures by pressing the shutter release button.

You can switch to other modes by pressing the  Playback button.

- Press the  Playback button once to switch to the "Playback mode". (The lens is not retracted.)
- Press and hold the  Playback button for 2 seconds to switch to the "Playback mode". (The lens is retracted.)
- Press and hold the  Playback button for more than 4 seconds to show the images stored in the built-in memory with the SD memory card installed.

2 Press the power switch again.

The camera turns off with the lens retracted.



If you press and hold the power switch for a while, the camera will be turned off.

Switching between Capture Mode and Playback Mode
 p.53

Turning the Camera On in Playback Mode

- 1 Press the power switch while pressing the  Playback button.**

The power indicator lights green and the camera turns on in the “Playback mode” with the lens retracted.

To switch to the “Capture mode”, press the  Playback button again.

Playing Back Still Pictures  p.37

Using the Button Functions

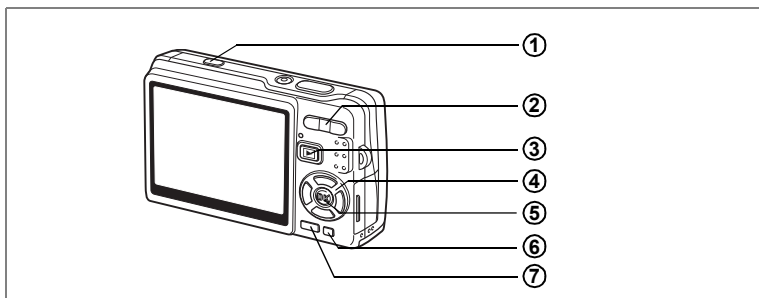

Capture Mode

- 1 Shake Reduction preview button**
Displays the compensated image on the LCD monitor while you are pressing the button. It allows you to preview the compensated image before shooting. (☞p.57)
- 2 ▲▲▲/▲ Zoom button**
Changes the size of the subject. (☞p.33, p.88)
- 3 ▶ Playback button**
Switches to the Playback mode. When pressed again, returns to Capture mode. (☞p.37)
- 4 Four-way controller (▲▼◀▶)**
(⏴▶) Changes the focus mode. (☞p.90)
(⏵▲) Changes the drive mode. (☞p.83 to p.87)
(MODE ▼) Displays the Capture Mode Palette. (☞p.50)
(⚡◀) Changes the flash mode. (☞p.93)
- 5 OK/Display button**
Changes the information displayed on the LCD monitor. (☞p.53)
When you press and hold the button for more than 1 second, the LCD Bright Mode is activated. The LCD monitor turns brighter for a certain amount of time. (☞p.36)
- 6 Green/🗑️ button**
Enters Green Mode. (☞p.59)
You can assign a different function to the Green button by selecting [Green Button] in the [📷 Rec.Mode] menu. (☞p.115)
- 7 MENU button**
Displays the [📷 Rec.Mode] menus. (☞p.45)

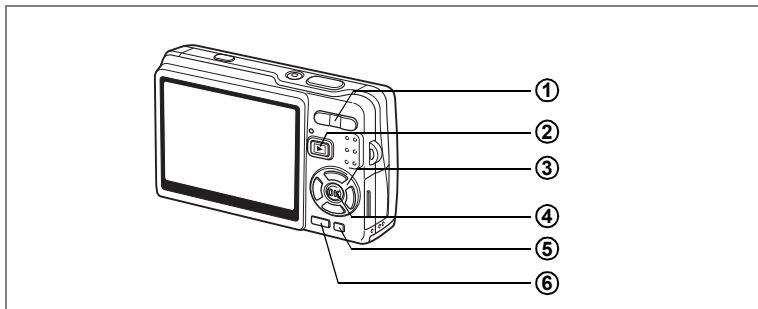

Playback Mode

- ① **Zoom button**
 Press $\blacktriangle\blacktriangle\blacktriangle/\square$ in single-image display to switch to nine-image display. Press \blacktriangle/Q to return to the previous display. (☞p.133)
 Press \blacktriangle/Q to enlarge the image in single-image display. Press $\blacktriangle\blacktriangle\blacktriangle/\square$ to return to the previous display. (☞p.129)
 Press $\blacktriangle\blacktriangle\blacktriangle/\square$ in nine-image display to switch to the calendar display. (☞p.133)
- ② **Playback button**
 Switches to Capture mode. When switched to the Playback mode by pressing the \square Playback button in Voice Recording mode, pressing the \square Playback button again switches to the Voice Recording mode.
- ③ **Four-way controller ($\blacktriangle\blacktriangledown\blacktriangleleft\blacktriangleright$)**
 For playing back still images
 ($\blacktriangleleft\blacktriangleright$) : Displays the previous or next image in single-image display. (☞p.37)
 When rotating the displayed image, the image is rotated 90 degrees clockwise each time you press the (\blacktriangleright), and 90 degrees counter clockwise each time you press the (\blacktriangleleft). (☞p.156)
 (\blacktriangledown) : Displays the Playback Mode Palette. (☞p.52)
 ($\blacktriangle\blacktriangledown\blacktriangleleft\blacktriangleright$) : Moves the display area of the enlarged image. (☞p.129)
 Selects an image in nine-image display. (☞p.133)
 Selects a date in calendar display. (☞p.133)
- For playing back movies
 (\blacktriangle) : Plays back and pauses a movie. (☞p.131)
 ($\blacktriangleleft\blacktriangleright$) : Frame forwards, frame reverses, fast forwards and reverses a movie during playback. (☞p.131)
 (\blacktriangledown) : Stops a movie during playback. (☞p.131)

For playing back voice recording files (☞p.126)

(▲) : Starts playback. When pressed again, pauses playback.

(◀▶) : Selects a recorded file before playback. Performs the following operations during playback.

Files with no recorded indexes:

(◀) Rewinds five seconds.

(▶) Advances five seconds.

Files with recorded indexes:

(◀) Starts playback from the previous index.

(▶) Starts playback from the next index.

④ **OK/Display button**

Changes the information displayed on the LCD monitor. (☞p.132)

When you press and hold the button for more than 1 second, the LCD Bright Mode is activated. The LCD monitor turns brighter for a certain amount of time. (☞p.37)

Returns to a single-image display in nine-image display. (☞p.133)

Displays the selected image full screen in calendar display. (☞p.133)

⑤ **Green/🗑️ button**

Deletes the image displayed on the LCD monitor. (☞p.137)

⑥ **MENU button**

Displays the [X↓ Set-up] menus. (☞p.45)

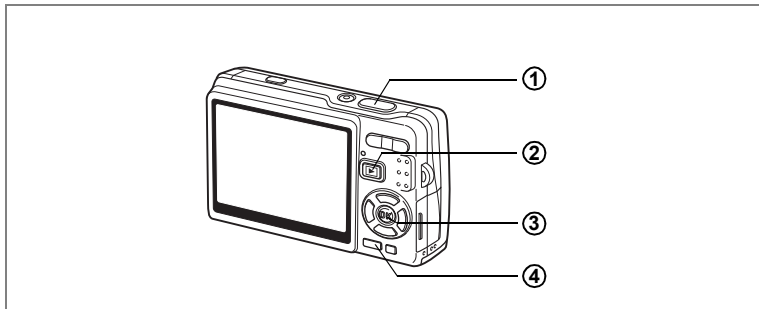

Voice Recording Mode

- ① **Shutter release button**
When pressed, starts recording. When pressed again, stops recording.
When pressed for more than one second, recording continues for as long as the button is held down and stops when the button is released.
- ② **▶ Playback button**
Switches to Playback mode. (☞p.40) When pressed again, returns to Voice Recording mode.
- ③ **OK/Display button**
Turns the LCD monitor on and off.
- ④ **MENU button**
When pressed during recording, an index can be added.
When pressed during standby or before playback, displays the [📷 Rec.Mode] menu. (☞p.45)

Setting the Menu

Press the MENU button to display the menu on the LCD monitor. There are two different menus, [📷 Rec.Mode] menu and [⏏ Set-up] menu.

How to Set the Menu

The button operation guide appears at the bottom of the LCD monitor while you are making settings for the menus.

1 Press the MENU button.

The [📷 Rec.Mode] menu appears. (The [⏏ Set-up] menu appears if the MENU button is pressed in Playback mode)

The selected area is highlighted.

2 Press the four-way controller (◀▶).

Each press switches between [📷 Rec.Mode] menu and [⏏ Set-up] menu.

3 Use the four-way controller (▲▼) to select an item.

Moves the highlight up or down.

4 Press the four-way controller (▶).

A pull-down menu or setting screen appears.

The pull-down menu displays only those items that can be selected for the current camera settings.

5 Use the four-way controller (▲▼) to change the setting.

The setting changes each time the four-way controller (▲▼) is pressed.

To Save the Setting and Start Taking Pictures

6 Press the shutter release button halfway.

The setting is saved and the camera enters the “Capture mode”.

When the shutter release button is pressed fully, the picture is taken.

To Save the Setting and Begin Playback of Images

6 Press the Playback button.

The setting is saved and the camera enters the “Playback mode”.

To Save the Setting and Continue with Menu Operations

6 Press the OK button or the four-way controller (◀).

The setting is saved and the screen returns to Step 3.

To Cancel the Changes and Continue with Menu Operations

6 Press the MENU button.

The changes are canceled and the screen returns to Step 3.

The MENU button functions differ depending on the screen activated at the time. See the button operation guide displayed at the bottom of the LCD monitor.

 Exit : Saves the current setting, exit the operation and return to the original screen (Capture or Playback mode).

  : Saves the current setting and return to Step 1.

 Cancel: Cancels the current selection, exit the operation and return to Step 3.



- If you press the MENU button with the pull-down menu displayed, the setting is cancelled.
- If you press the OK button, the MENU button or the four-way controller (◀) with the pull-down menu displayed, the menu returns to the screen used for selecting an item.
- The menu is exited automatically one minute after the last operation.

Example of Menu Operation

1 MENU button

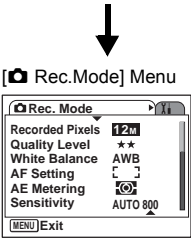

2



3

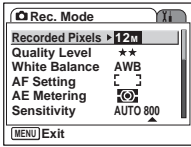

3

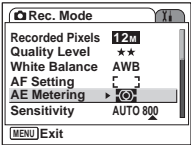

3

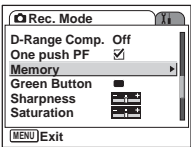

3

To the next screen

4

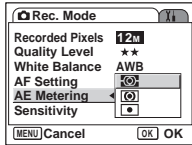

4'

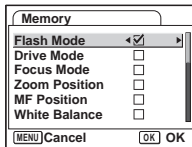

Menu List

[📷 Rec.Mode] Menu

Item		Description	Page
Recorded Pixels		For selecting the number of pixels	p.95
Quality Level		For selecting the image compression ratio	p.97
White Balance		For adjusting the color balance according to lighting	p.98
AF Setting	Focusing Area	For changing the area of the autofocus	p.100
	Focus Limiter	For limiting the focusing range of the lens in accordance with the shooting conditions	p.101
	Aux. AF Light	For focusing with auxiliary AF light when the subject is dim and the autofocus does not function properly	p.102
AE Metering		For setting the metering method to determine the exposure	p.103
Sensitivity		For setting the sensitivity	p.104
EV Compensation		For adjusting the exposure between -2.0EV and +2.0EV	p.106
Movie	Recorded Pixels	For selecting the recorded pixels of the movie	p.107
	Quality Level	For selecting the quality level of the movie	p.108
	Movie SR	For compensating for camera shake of the movie automatically	p.109
Shake Reduction		For reducing camera shake while taking still pictures	p.110
Digital Zoom		For taking digital zoom pictures	p.88
Instant Review		For setting the Instant Review time	p.111
Face Priority		For setting the face recognition function	p.112
D-Range Comp.		For making dark portions brighter while keeping the exposure level for the entire image	p.113
One push PF		For pressing the shutter release button all the way down (single step) to shorten the shutter delay when taking a picture	p.114
Memory		For saving the shooting function settings when the camera is turned off	p.122
Green Button		For registering a function on the Green button	p.115
Sharpness		For setting the sharpness	p.118
Saturation		For setting the saturation	p.119
Contrast		For setting the contrast	p.120
Date Imprint		For imprinting the date on still pictures	p.121

[X] Set-up] Menu

Item	Description	Page
Format	For formatting the SD Memory Card or built-in memory	p.174
Sound	For adjusting the operation sound volume and the playback volume, and setting the type and volume of start-up sound, shutter sound, key operation sound and self-timer sound.	p.175
Date Adjust	For adjusting the date, time and display style	p.178
World Time	For setting the world time	p.180
Language/言語	For changing the language in which menus and messages appear	p.182
Folder Name	For selecting the way of naming image folders	p.183
USB Connection	For changing the USB connection mode	p.184
Video Out	For setting the video output format	p.185
Brightness Level	For changing the brightness of the LCD monitor	p.186
Power Saving	For setting the Power Saving function	p.187
Quick Zoom	For displaying the image at specified magnification by pressing the zoom button once	p.130
Auto Power Off	For turning off the power automatically	p.188
Guide Display	For showing the mode selected on the screen in Capture mode, the status of the four-way controller, and assignment of the Green button. For showing the description for the selected item on the Mode Palette.	p.189
Reset	For returning the camera settings to defaults	p.189

Operating the Mode Palette

Press the four-way controller (▼) to display the Mode Palette on the LCD monitor.

There are two different Mode Palettes, the “Capture Mode Palette” and the “Playback Mode Palette.” You can activate the Capture mode most appropriate for the shooting conditions or edit the taken images just by selecting the icons.

How to operate the Mode Palette

The button operation guide appears at the bottom of the LCD monitor while you are using the Mode Palette.

1 Press the four-way controller (▼).

In Capture mode, the “Capture Mode Palette” appears.

In Playback mode, the “Playback Mode Palette” appears.

2 Use the four-way controller (▲▼◀▶) to select an icon.

3 Press the OK button.

The screen for the selected mode appears.

Mode Palette List

Capture Mode Palette

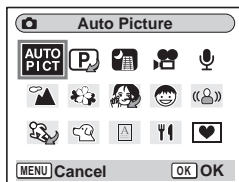

Icon	Item	Description	Page
	Auto Picture mode	Selects the best capture mode.	p.61
	Program mode	Lets you take clear pictures at the appropriate shutter speed and exposure.	p.63
	Shutter Priority mode	Automatically sets the required aperture value when a shutter speed is manually selected.	
	Manual Exposure mode	Allows you to set shutter speed and aperture value manually.	

Icon	Item	Description	Page
	Night Scene mode	Lets you take dark scenes such as night views.	p.77
	Movie mode	Lets you take movies and sounds.	p.79
	Voice Recording mode	Records audio, such as voices.	p.124
	Landscape mode	Lets you capture the natural colors of landscape views.	p.67
	Flower mode	Lets you take brightly colored flower pictures.	
	Natural Skin Tone mode	Lets you take pictures with skin tone more beautiful than Portrait mode.	p.69
	Portrait mode	Lets you take portraits with spatial effect, by emphasizing the person.	
	Half-length Portrait mode	Lets you take portraits at a certain angle of view.	
	Kids mode	Ideal for taking pictures of moving children. Also gives them a healthy look.	
	Surf & Snow mode	Lets you take pictures against dazzling backgrounds like beaches or snow-covered mountains.	p.67
	Sport mode	Lets you take clear pictures of moving subjects with a high shutter speed to prevent motion blur.	
	Pet mode	Lets you take clear pictures of pets to fit their hair color.	p.75
	Text mode	Lets you take clear pictures of text or writing. Also lets you turn colored text black/white or reverse color.	p.76
	Food mode	Lets you take appetizing pictures of prepared food.	p.67
	Digital SR mode	Sets the sensitivity higher to reduce camera shake and blurring.	p.78
	Frame Composite mode	Lets you take pictures with a decorative frame.	p.81

- When you select an icon on the Mode Palette, waiting for about 3 seconds, the description for the selected mode appears.
- For /, // and /, icons to be selected are displayed. The currently selected mode icons are displayed on the Mode Palette. If you change the selection, the newly selected icons replace the previous ones.

Playback Mode Palette

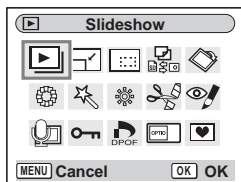

Icon	Item	Description	Page
	Slideshow	For playing recorded images successively	p.135
	Resize	For changing the size and quality level of images	p.153
	Cropping	For cropping images and saving them as separate images	p.155
	Image/ Sound Copy	For copying files from the built-in memory to the SD Memory Card and vice versa	p.170
	Image Rotation	For displaying rotated still pictures	p.156
	Color Filter	For processing images using the color filter	p.157
	Digital Filter	For applying special effects such as the illustration effect or the slim effect to still pictures according to your taste	p.159
	Brightness Filter	For adjusting the brightness of images using a filter	p.161
	Movie Edit	For editing movies	p.163
	Red-eye Compensation	For retouching red-eyes, a phenomenon that can happen when shooting with a flash	p.166
	Voice Memo	For adding a voice memo to an image	p.127
	Protect	For protecting images and sounds to avoid accidental erasure	p.142
	DPOF	For printing images from a DPOF compatible printer or at a printing service	p.146
	Start-up Screen	For setting the start-up screen	p.172
	Frame Composite	For adding a decorative frame to a still picture	p.168



When you select an icon on the Mode Palette, waiting for about 3 seconds, the description for the selected mode appears.

Changing the Mode

In the “Capture mode”, you can take pictures. In the “Playback mode”, you can play back or delete pictures.

Switching between Capture Mode and Playback Mode

To switch from the “Capture mode” to the “Playback mode”

Press the  Playback button.

To switch from the “Playback mode” to the “Capture mode”

Press the  Playback button or press the shutter release button halfway.

Selecting the Capture Mode

Display the “Capture Mode Palette” and select the icon for a desired mode. (p.50)

Displaying Shooting Information in Capture Mode

In the Capture mode, press the OK/Display button to switch the “display modes”. There are 5 display modes for the Capture mode.



Normal Display

Shooting information is displayed when the power is turned on.

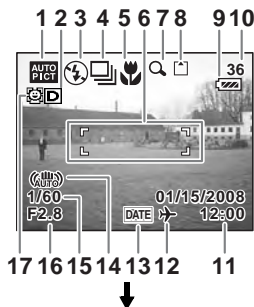
- | | |
|--|------------------------|
| 1 Capture mode | 2 D-Range Comp. |
| 3 Flash mode | 4 Drive mode |
| 5 Focus mode | 6 Focus frame |
| 7 Digital zoom | 8 Card/Built-in memory |
| 9 Battery indicator | |
| 10 Remaining number of recordable images | |
| 11 Date and time | 12 World Time setting |
| 13 Date Imprint | 14 Shake Reduction On* |
| 15 Aperture | 16 Shutter speed |
| 17 Face Priority On | |



* The information on Shake Reduction is displayed as follows.

-  (Shake Reduction On) : Appears when you press the shutter release button halfway with [Shake Reduction] set to [On].
-  (Shake Reduction Off): Always displayed when [Shake Reduction] is set to [Off].
-  (Anti-shake warning) : Appears when camera shake may occur due to slower shutter speed.

Histogram Display

The brightness distribution of the image is displayed. The horizontal axis shows the brightness (darkest at the left end and brightest at the right end) and the vertical axis shows the number of pixels.

- | | |
|-------------------|-----------------|
| 1 Recorded Pixels | 2 Quality Level |
| 3 White Balance | 4 AE Metering |
| 5 Sensitivity | 6 Histogram |

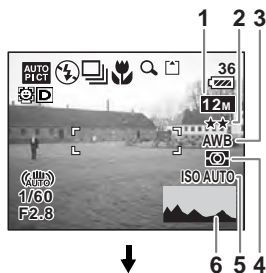

Grid Display

The grids divide the screen into nine parts. These grids will help you to improve composition.

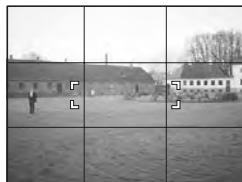

No icons

No shooting information is displayed.

- The focus frame appears in Autofocus mode.
- If any of the settings are changed, the icon of the setting appears for a few seconds.



LCD Backlight Off

The LCD monitor is turned off.

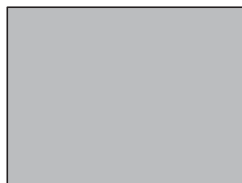

Saving the Display Mode  p.122



- If you press and hold the OK/Display button for more than 1 second, the LCD Bright Mode is activated. The LCD monitor turns brighter for a certain amount of time. (p.36)
- Under shooting conditions where camera shake is likely to occur,  (Anti-shake warning) will be displayed. Take pictures using the Shake Reduction function or with the camera secured on a tripod or other stable surface. (p.57)
- All the camera buttons function as usual even when the LCD backlight is off. Press the shutter release button to take pictures as usual.

Using Histogram

A histogram is a graph showing the brightness of an image on the horizontal axis and the number of pixels on the vertical axis (distribution chart of the brightness). The histogram will help you detect the brightness of the image you have taken. For instance, the graph peak tends to appear on the left side for a darker image, and the graph peak tends to appear on the right side for a brighter image.

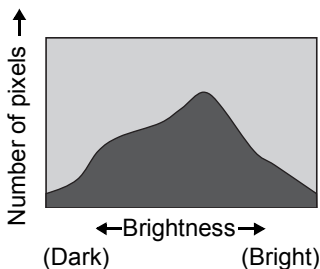

In general, when the exposure metering of your image is well-balanced, the graph peaks tend to appear in the middle. On the contrary, when the exposure metering of the subject is imbalanced, that is with dark areas and/or bright areas, the peaks will appear on the sides rather than in the middle.

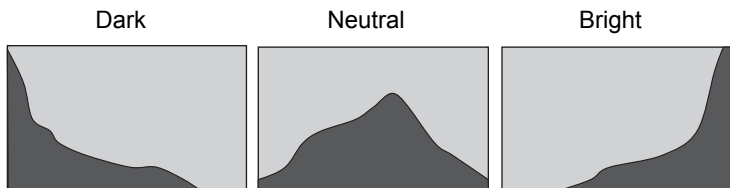

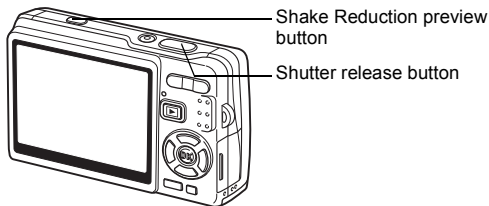

Taking Pictures Using the Shake Reduction Function

“Camera shake” occurs when you jiggle your hands while taking pictures. “Blurring” is likely to occur when you take pictures of moving subject. This camera features image compensation systems and functions that work for both “camera shake” and “blurring”. Enjoy taking still pictures and movies without worrying about image blur.

Shake Reduction function for still images

The CCD-shifting shake reduction system * is activated.

The camera detects the shake of your hands and automatically compensates for image blur. You can preview the compensated image on the LCD monitor before taking the picture.

* The unique shake reduction system of PENTAX.

Digital SR mode

The mode allows you to set the sensitivity to maximum ISO3200. The higher shutter speed enables the reduction of both “camera shake” and “blurring”.

“Reducing Camera Shake and Blurring in Pictures (Digital SR Mode)” p.78

Movie SR function for movies

The movie anti-shake function electronically compensates for image blur. It allows you to take smooth movies without worrying about camera shake.

“Compensating for Camera Shake While Taking Movies (Movie SR)” p.109

When [Shake Reduction] in [📷 Rec.Mode] menu is set to [☑ (On)], the camera always compensates for camera shake. ([☑ (On)] is selected by default.)

Follow the procedures below if you wish to preview the compensated image on the LCD monitor before taking the picture.

1 Press the Shake Reduction preview button.

The compensated image is displayed on the LCD monitor while pressing the button.

2 Press the shutter release button fully.

The picture is taken.



Do not press the Shake Reduction preview button unless it is necessary. If you press the button, even when the camera is not in the Capture mode, the Shake Reduction function is activated and will waste battery power.



If you do not wish to preview the compensated image before shooting, take pictures in the basic way, that is, press the shutter release button halfway, and then press it fully. Be sure to confirm that (📷) appears on the LCD monitor before pressing the shutter release button fully.

“Setting the Shake Reduction Function for Still Images to On” p.110

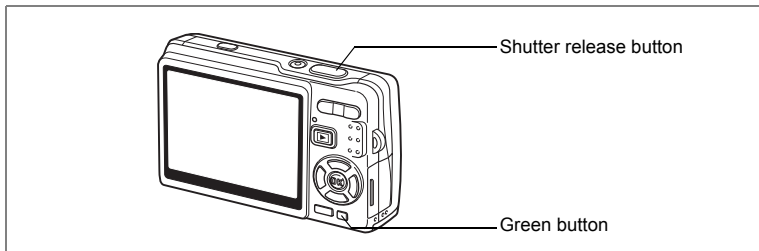

Taking Pictures in the Basic Mode (Green Mode)

In the Green Mode, you can enjoy easy picture taking just by pressing the shutter release button.

“Face Recognition AF” and “Face Recognition AE” are activated. When you point the camera at your subject's face, the camera automatically recognizes it, adjusting both focus and exposure.

1 Press the Green button in Capture mode.

The camera enters the Green Mode. Press the Green button again to return to the previous status.

2 Press the shutter release button halfway.

The focus frame on the LCD monitor will light green when the camera is in focus.

3 Press the shutter release button fully.

The picture is taken.





- In the Green Mode, you cannot change the information displayed on the LCD monitor by pressing the OK/Display button.
- In the Green Mode, you cannot display the [📷 Rec. Mode] menu or the Capture Mode Palette. If you try to show them, the message [Green mode must be canceled to use this function.] and 🔒 (key lock icon) appear.
- When the camera switches from the Green Mode to Playback Mode, you cannot display the [X↓ Set-up] menu by pressing the MENU button. If you try to show it, the message [Green mode must be canceled to use this function.] and 🔒 (key lock icon) appear.
- When the camera is turned off in the Green Mode, it starts up in the Green Mode next time you turn on the camera.

4



You can assign a different function to the Green button by selecting [Green Button] in the [📷 Rec.Mode] menu. (p.115)

The list below shows the settings for the Green Mode.

Flash mode	The default is (Auto). (Flash Off) can be selected.
Drive mode	The default is (Standard). (Self-timer) can be selected.
Focus mode	The default is AF (Standard). (Macro mode), PF (pan focus) can be selected.
Recorded Pixels	12M
Quality level	★★ (Better)
White Balance	AWB (Auto)
Focusing Area	(Multiple)
Focus Limiter	<input checked="" type="checkbox"/> (On)
Aux. AF Light	<input checked="" type="checkbox"/> (On)
AE Metering	(Multi-segment)
Sensitivity	AUTO
EV Compensation	± 0.0
Digital Zoom	<input checked="" type="checkbox"/> (On)
Instant Review	0.5sec
Face Priority	<input checked="" type="checkbox"/> (On)
D-Range Comp.	<input type="checkbox"/> (Off)
One push PF	<input checked="" type="checkbox"/> (On)
Sharpness	(Standard)
Saturation	(Standard)
Contrast	(Standard)
Date Imprint	<input type="checkbox"/> (Off)

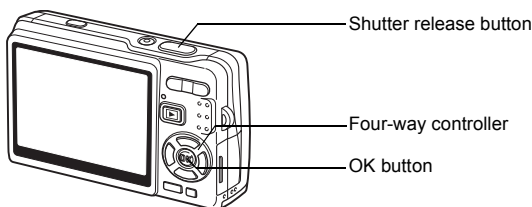

Taking Pictures Automatically (Auto Picture Mode)

In **AUTO PICT** (Auto Picture mode), the camera selects the most appropriate capture mode from ☺ (Normal mode), 🌃 (Night Scene mode), 🏞️ (Landscape mode) and 👤 (Portrait mode) just by pressing the shutter release button.

"Face Recognition AF" and "Face Recognition AE" are activated. When you point the camera at your subject's face, the camera automatically recognizes it, adjusting both focus and exposure.

1 Press the four-way controller (▼) in Capture mode.

The Mode Palette appears.

2 Use the four-way controller (▲▼◀▶) to select **AUTO PICT** (Auto Picture mode).

3 Press the OK button.

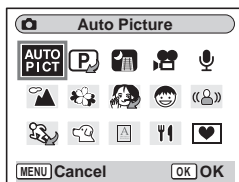

4 Press the shutter release button halfway.

The focus frame on the LCD monitor will light green when the camera is in focus, and the selected mode icon will appear on the top left of the LCD monitor.





5 Press the shutter release button fully.

The picture is taken.

Taking Still Pictures  p.33



- In Auto Picture mode, the exposure is fixed to ± 0.0 . ( p.106)
- When the camera selects Portrait mode, “Face Recognition AF” and “Face Recognition AE” are activated. When you point the camera at your subject’s face, the camera automatically recognizes it, adjusting focus and exposure to take a high-quality picture. ( p.69)

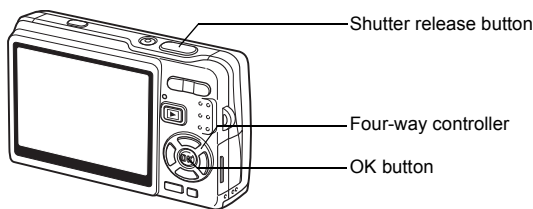

Using the Exposure Mode and Other Functions

P (Program mode), **Tv** (Shutter Priority mode) and **M** (Manual Exposure mode) allow you to take pictures with various aperture and shutter speed settings (Exposure modes).

P	Program	Sets shutter speed and aperture automatically for proper exposure.
Tv	Shutter Priority	Set shutter speed manually. Aperture is set automatically.
M	Manual Exposure	Set both shutter speed and aperture manually.

● Effect of Aperture and Shutter Speed

There are many correct combinations of shutter speed and aperture for a particular subject. Different combinations produce different effects on a picture.

Slower shutter speed	The shutter remains open for a longer time. If the subject is moving, the image will be blurred while the shutter is open, thus enhancing the effect of motion.
Faster shutter speed	The shutter remains open for a shorter time. It allows freezing the action of a moving subject.
Smaller aperture value	Decreases the amount of light which enters through the lens.
Higher aperture value	Increases the amount of light which enters through the lens.

1 Press the four-way controller (▼) in Capture mode.

The Mode Palette appears.

2 Use the four-way controller (▲▼◀▶) to select **P** (Program mode).

If you have selected an exposure mode other than **P** (Program mode), the icon of the selected mode is displayed on the Mode Palette.

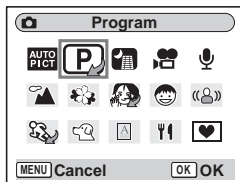

3 Press the OK button.

The selected icon is displayed.



To Select the Program mode

4 Use the four-way controller (▲▼) to select **P** (Program mode), and press the OK button.

The camera is ready for taking pictures.
Set other functions when necessary.

"Setting the Shooting Functions" p.90~p.120

To Select the Shutter Priority mode

4 Use the four-way controller (▲▼) to select **TV** (Shutter Priority mode), and press the OK button.

5 Press the four-way controller (▼).

The screen for selecting the shutter speed appears.



Shutter speed

6 Use the four-way controller (◀▶) to select a desired shutter speed.

The proper aperture value will be set automatically.

If the camera cannot adjust it appropriately, an exposure warning appears in the bottom center of the LCD monitor.

Adjust the exposure using the warning as a reference.

When ∇ appears: Increase the shutter speed.

When \blacktriangle appears: Decrease the shutter speed.



Compensation value

Exposure warning



If you compensate the exposure (p.106) already set in Shutter Priority mode, the compensation value appears below the exposure warning.

7 Press the OK button.

The camera is ready for taking pictures.

Set other functions when necessary.

"Setting the Shooting Functions" p.90~p.120

To Select the Manual Exposure mode

4 Use the four-way controller (▲▼) to select **M** (Manual Exposure mode), and press the OK button.

5 Press the four-way controller (▼).

The screen for selecting the shutter speed and aperture value appears.

6 Use the four-way controller (◀▶) to select a desired shutter speed and (▲) to select a desired aperture value.



Aperture Shutter speed

Depending on the shutter speed and aperture value you set, an exposure warning may appear for your reference.

7 Press the OK button.

The camera is ready for taking pictures.
Set other functions when necessary.

“Setting the Shooting Functions” p.90~p.120



- Only the icon of the selected exposure mode is displayed on the Mode Palette. When you switch to another exposure mode, the icon of the newly selected mode replaces the previous one.
- You can display the Capture Mode Palette by pressing the four-way controller (▼) while showing the screen for selecting the shutter speed and aperture value.
- In **[TV]** (Shutter Priority mode), Sensitivity is fixed to AUTO800.
- In **[TV]** (Shutter Priority mode) and **[M]** (Manual Exposure mode), the exposure warning is shown as follows.
 - When the exposure is greater than +2.0EV or less than -2.0EV, an icon (☒ or ☓) is displayed.
 - When the exposure is between +2.0EV to -2.0EV, an icon (☒ or ☓) and the exposure value are displayed.
 - When the exposure is adequate at 0EV, no warning is displayed.

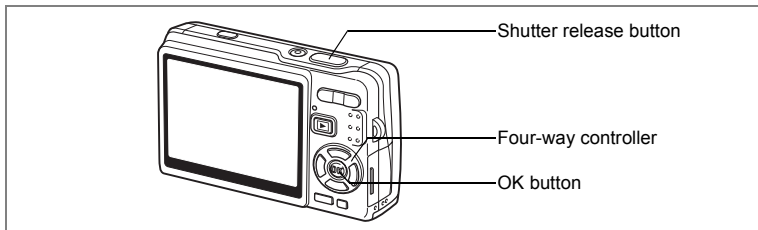

Selecting the Picture Mode According to the Shooting Scene (Picture Mode)

You can select the Picture mode according to the shooting scene. There are 11 available modes in Picture mode.

	Landscape	Lets you capture the natural colors of landscape views.
	Flower	Lets you take brightly colored flower pictures.
	Natural Skin Tone	Lets you take pictures with soft flash to produce beautiful skin tones.
	Portrait	Lets you take portraits with spatial effect, by emphasizing the person.
	Half-length Portrait	Lets you take portraits at a certain angle of view.
	Kids	Ideal for taking pictures of moving children. Also gives them a healthy look.
	Sport	Lets you take clear pictures of moving subjects with a high shutter speed.
	Surf & Snow	Lets you take photos against dazzling backgrounds like beaches or snow-covered mountains.
	Pet	Lets you take clear pictures of pets to fit their hair color.
	Text	Lets you take clear pictures of text or writing. Also lets you turn colored text black/white or reverse color.
	Food	Lets you take appetizing pictures of prepared food.

1 Press the four-way controller (▼) in Capture mode.

The Mode Palette appears.

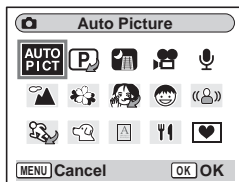

2 Use the four-way controller (▲▼◀▶) to select a desired mode.

For example, select  (Landscape mode).

3 Press the OK button.

4 Press the shutter release button halfway.

The focus frame on the LCD monitor will light green when the camera is in focus.

5 Press the shutter release button fully.

The picture is taken.

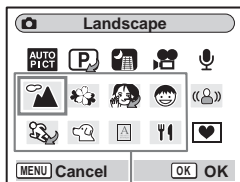

Picture modes

4



In Picture modes, Saturation, Contrast, Sharpness, White Balance and AE Metering are automatically set to their default settings. You cannot change these settings.

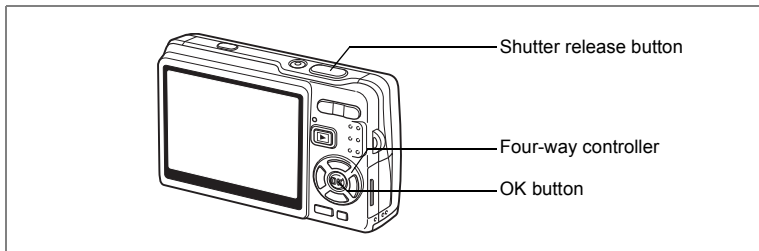

Taking Pictures of People (Natural Skin Tone/Portrait Mode/Half-length Portrait)

In (Natural Skin Tone), (Portrait mode) and (Half-length Portrait mode), “Face Recognition AF” and “Face Recognition AE” are activated. When you point the camera at your subject’s face, the camera automatically recognizes it, adjusting both focus and exposure.

	Natural Skin Tone	Lets you take pictures with soft flash to produce beautiful skin tones.
	Portrait	Lets you take portraits with spatial effect, by emphasizing the person.
	Half-length Portrait mode	Lets you take portraits at a certain angle of view based on the size and position of the the subject’s face when recognizing the face.

1 Press the four-way controller (▼) in Capture mode.

The Mode Palette appears.

2 Use the four-way controller (▲▼◀▶) to select (Natural Skin Tone).

If (Portrait mode) or (Half-length Portrait mode) was previously selected, select (Portrait mode) or (Half-length Portrait).

3 Press the OK button.

When (Natural Skin Tone) is selected, icons to be selected are displayed. Press the four-way controller (▲▼) to select the desired mode and press the OK button. The camera is ready for taking pictures in the selected mode.

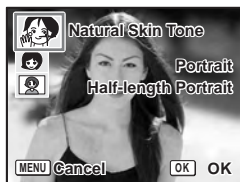

When the camera recognizes the subject's face, a yellow focus frame appears on it. The position and the size of the frame change while the camera continues to adjust the focus on the moving subject.

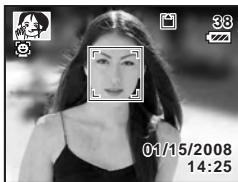

4 Press the shutter release button halfway.

The focus frame on the LCD monitor will light green when the camera is in focus.

5 Press the shutter release button fully.

The picture is taken.



- If the camera cannot recognize the subject's face in Portrait mode, the camera focuses using the Focusing Area (Multiple).
- "Face Recognition AF" and "Face Recognition AE" may not work if the subject's face is partly covered, for example, with sunglasses, or when the subject does not face the camera.
- The AE metering mode is fixed to Multi-segment.
- When you select Auto Picture mode and the camera automatically switches to Portrait mode, "Face Recognition AF" and "Face Recognition AE" are activated.

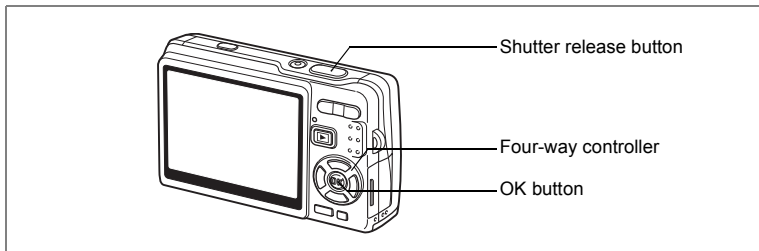

Taking Pictures of Kids (Kids Mode)

☺ (Kids mode) is ideal for taking pictures of moving children. Also gives them a healthy look. “Face Recognition AF” and “Face Recognition AE” are activated. When you point the camera at your subject’s face, the camera automatically recognizes it, adjusting both focus and exposure.

1 Press the four-way controller (▼) in Capture mode.

The Mode Palette appears.

2 Use the four-way controller (▲▼◀▶) to select ☺ (Kids mode).

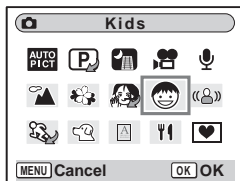

3 Press the OK button.

While the Face Priority is set to On, a yellow focus frame appears on the subject’s face when the camera recognizes it. The position and the size of the frame change while the camera continues to adjust the focus on the moving subject.

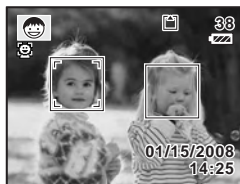

4 Press the shutter release button halfway.

The focus frame on the LCD monitor will light green when the camera is in focus.

5 Press the shutter release button fully.



The picture is taken.

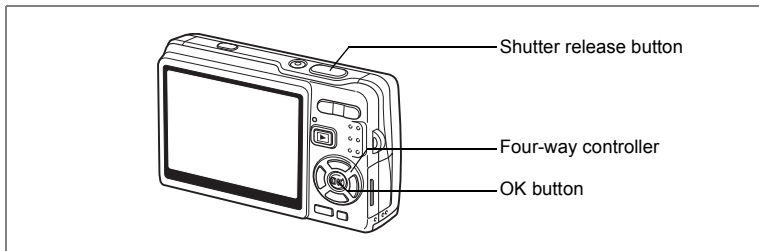

- “Face Recognition AF” and “Face Recognition AE” may not work if the subject’s face is partly covered, for example, with sunglasses, or when the subject does not face the camera.
- The AE metering mode is fixed to Multi-segment.
- The automatic tracking AF function is activated. The camera continues to adjust the focus on the moving subject even after you press the shutter release button halfway.
- Red-eye reduction is automatically performed when using Facial Recognition in Kids mode with the flash mode set to Auto or Flash On.







Taking Pictures of Sports and Leisure Activities (Sport Mode/Surf & Snow Mode)

	Sport	Lets you take pictures of fast moving subjects.
	Surf & Snow	Lets you take photos against dazzling backgrounds like ocean beaches or ski slopes.

1 Press the four-way controller (▼) in Capture mode.

The Mode Palette appears.

2 Use the four-way controller (▲▼◀▶) to select (Sport mode).

If  (Surf & Snow mode) was previously selected,  is displayed on the Mode Palette instead of . Select  (Surf & Snow mode) then.

3 Press the OK button.

The selected icon is displayed.

4 Press the four-way controller (▲▼) to select (Sport mode) or (Surf & Snow mode).



5 Press the OK button.

The camera is ready for taking pictures in the selected mode.

6 Press the shutter release button halfway.

The focus frame on the LCD monitor will light green when the camera is in focus.

7 Press the shutter release button fully.

The picture is taken.



- The fixed settings for the EV Compensation, White Balance, AE Metering, Saturation, Contrast, and Sharpness for each mode are permanent and cannot be changed.
- In the Sports mode, the flash cannot be used, the AF light is off, and the AF area tracking is set, but these settings can be changed.

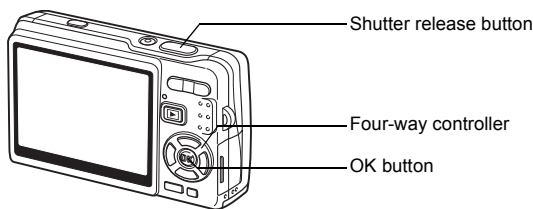

Taking Pictures of Your Pet (Pet Mode)

In  (Pet mode), you can take pictures that show natural hair color of your pet. Select the appropriate icon depending on what color your pet is (closer to black or white or in between).

- 1 Press the four-way controller (▼) in Capture mode.**
The Mode Palette appears.
- 2 Use the four-way controller (▲▼◀▶) to select  (Pet mode).**
- 3 Press the OK button.**

The screen for selecting the pet mode appears.

- 4 Use the four-way controller (▲▼) to select , , ,  or .**

There are two types of pet icon; dogs' and cats'. Selecting either the cat or dog icon does not affect the resulting picture. Select whichever you prefer.

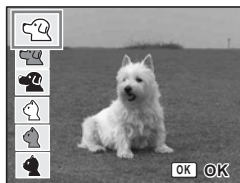

- 5 Press the OK button.**
The desired Pet mode is selected and the camera is ready for taking pictures.
- 6 Press the shutter release button halfway.**

The focus frame turns green when the subject is in focus.



- 7 Press the shutter release button fully.**
The picture is taken.



When you select Pet mode or Sport mode, the automatic tracking AF function is activated and the camera continues to adjust the focus on the moving subject even after the shutter release button is pressed halfway.

Taking Pictures of Text (Text Mode)

This mode allows you to take clear pictures of written text. This is convenient for capturing a digital copy of an important document or enhancing legibility of small print.

1 Press the four-way controller (▼) in Capture mode.

The Mode Palette appears.



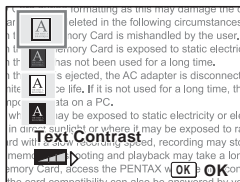

2 Use the four-way controller (▲▼◀▶) to select (Text mode).

3 Press the OK button.

The screen for selecting the Text mode appears.



4 Use the four-way controller (▲▼) to select , , , or .

	Color	Maintains original colored text.
	Neg. Color	Reverses colored text.
	B&W	Turns colored text black/white.
	Neg. B&W	Reverses black/white text.

Press the four-way controller (◀▶) to adjust the contrast.

5 Press the OK button.

The desired text mode is selected and the camera is ready for taking pictures.

6 Press the shutter release button halfway.

The focus frame turns green when the subject is in focus.

7 Press the shutter release button fully.

The picture is taken.

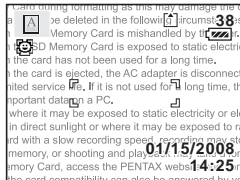

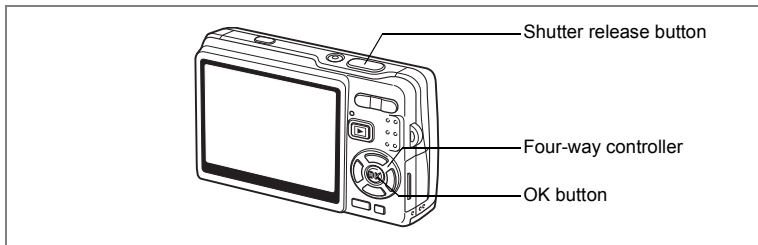

Taking Pictures of Dark Scenes (Night Scene Mode)

You can take pictures of dark scenes, such as nightscapes, with the appropriate settings.

1 Press the four-way controller (▼) in Capture mode.

The Mode Palette appears.

2 Use the four-way controller (▲▼◀▶) to select 🌃 (Night Scene mode).

3 Press the OK button.

4 Press the shutter release button halfway.

The focus frame on the LCD monitor will light green when the camera is in focus.

5 Press the shutter release button fully.

The picture is taken.

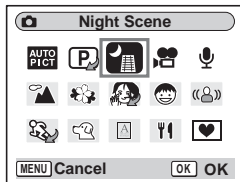

Total recording time will be longer when the picture is taken at slower shutter speed (approximately 1/4 second or slower), because the noise reduction function is activated to reduce noise.



The shutter speed becomes slower when taking pictures of dark scenes. The camera shake is likely to occur under such condition. The followings are good ways to prevent camera shake. (☞ p.57, 110)

- Activate the Shake Reduction function.
- Set Shake Reduction to Off and secure the camera on a tripod or other stable object.

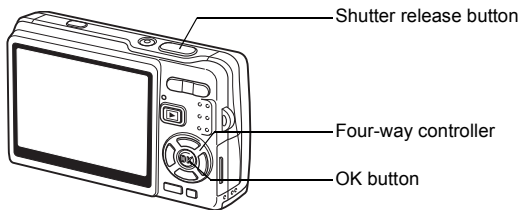

Reducing Camera Shake and Blurring in Pictures (Digital SR Mode)

☺ (Digital SR) mode allows you to set the sensitivity higher than other modes to reduce camera shake and blurring. Shutter speed and aperture are set automatically according to the sensitivity value you set. Use the mode under the shooting conditions that camera shake or blurring tend to occur.

1 Press the four-way controller (▼) in Capture mode.

The Mode Palette appears.

2 Use the four-way controller (▲▼◀▶) to select ☺ (Digital SR mode).

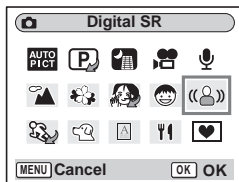

3 Press the OK button.

4 Press the shutter release button halfway.

The focus frame on the LCD monitor will light green when the camera is in focus.

5 Press the shutter release button fully.

The picture is taken.



- The recorded pixels are fixed to 5M and cannot be changed.
- In Digital SR mode, Sensitivity is set to AUTO1600 by default. The ISO Correction range can be set to maximum ISO 50-3200. (p.104)

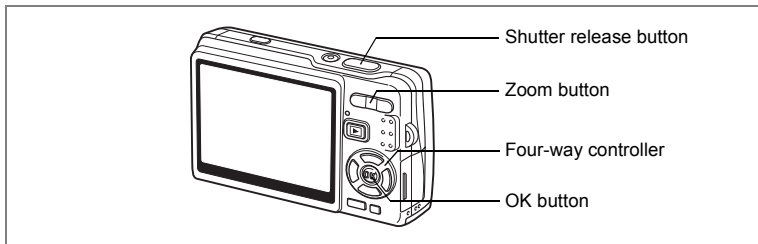

Taking Movies (Movie Mode)

This mode enables you to take movies with sound.

- 1 Press the four-way controller (▼) in Capture mode.**

The Mode Palette appears.

- 2 Use the four-way controller (▲▼◀▶) to select  (Movie mode).**

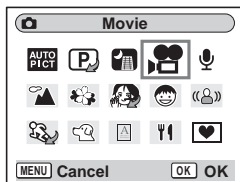

- 3 Press the OK button.**

The following shooting information appears on the LCD monitor and the camera is ready for taking movies.

- | | |
|--------------------|------------------------|
| 1 Face Priority On | 2 Movie mode icon |
| 3 Flash Off icon | 4 Card/Built-in memory |
| 5 Recordable time | 6 Movie SR On |



- 4 Press the shutter release button.**

Shooting starts. Press the zoom button to change the size of the subject using Digital Zoom.

Zoom button (▲): Enlarges the subject.
 Zoom button (◆◆◆): Diminishes the subject.

- 5 Press the shutter release button.**

Shooting ends.

Keeping the Shutter Release Button Pressed

If you keep the shutter release button pressed for more than one second, the movie will be taken for as long as you keep the button pressed. Shooting stops when you take your finger off the shutter release button.



- The followings are not available in Movie mode.
 - Flash
 - Continuous Shooting
 - Multi-exposure
 - Operating with a remote control unit
 - Optical zoom and Intelligent Zoom (Available before shooting starts.)
- Set Movie SR to Off in [📷 Rec.Mode] menu to use Digital Zoom in Movie mode. (📖 p.109)
- The Focusing Area is fixed to Spot, and the Focus Limiter and the auxiliary AF light are set to Off in Movie mode. When Focus Mode is set to Standard (Autofocus), Macro, or Super Macro, the AF operation is performed once right before starting taking a movie.
- You can continuously record a movie until its file size reaches 2 GB on a high-capacity SD Memory Card.

Playing Back Movies 📖p.131

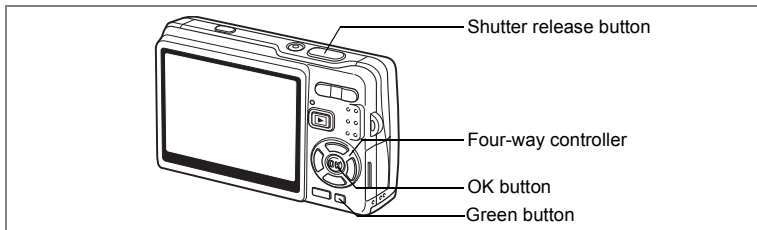

Taking Pictures in Frame Composite mode

You can take pictures with a decorative frame added using the Frame Composite function. There are three frames already stored in the camera.

1 Press the four-way controller (▼) in Capture mode.

The Mode Palette appears.

2 Use the four-way controller (▲▼◀▶) to select (Frame Composite).

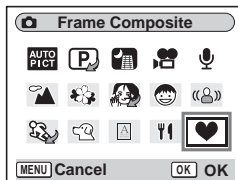

3 Press the OK button.

The frame selection screen appears.

4 Use the four-way controller (◀▶) to select a frame.



5 Press the OK button.

The subject appears in the selected frame.

6 Press the shutter release button halfway.

The focus frame on the LCD monitor will light green when the camera is in focus.



7 Press the shutter release button fully.

The picture is taken.



- The Recorded Pixels is fixed to 3M, and cannot be changed to any other size.
- Continuous Shooting is not possible in Frame Composite mode.

To Register a New Frame

To switch to the screen for registering a frame, press the Green button in Step 3. You can register frames which you have downloaded from the internet, etc. When you register a new frame, it replaces one of the existing frames in the built-in memory. Before you register a new frame, copy it to the SD Memory Card.

4

Taking Pictures



When a new frame on the SD Memory Card is registered in the built-in memory, it replaces one of the existing frames in the built-in memory. The replaced frame is deleted from the built-in memory.

1 In the frame selection screen, select the frame you want to remove and press the Green button.

A message appears and the frames on the SD Memory Card that you can register in the built-in memory appear.

2 Use the four-way controller (◀▶) to select the frame you want to register and press the OK button.

The frame is registered in the built-in memory instead of the frame selected in Step 1.

Visit the PENTAX website at the URL below to download new frames.

http://www.pentax.co.jp/english/support/digital/frame_02.html

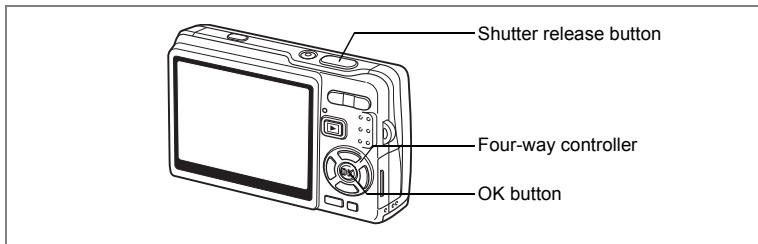

Using the Self-timer

In self-timer mode, the picture is taken ten seconds or two seconds after the shutter release button is pressed.

- 1 Press the four-way controller (▲) in Capture mode.**
- 2 Press the four-way controller (◀▶) to select ⏰ (Self-timer) or ⏱ (2 sec. Self-timer).**
- 3 Press the OK button.**

The camera is ready for taking pictures using the Self-timer.



- 4 Press the shutter release button halfway.**

The focus frame on the LCD monitor will light green when the camera is in focus.

- 5 Press the shutter release button fully.**

The self-timer starts running.

- ⏰ (Self-timer) : The picture is taken after the self-timer lamp lights for about seven seconds, then blinks for about three seconds.
- ⏱ (2 sec. Self-timer): The picture is taken after the self-timer lamp blinks for about two seconds.



Focusing may be compromised if you move the camera while the self-timer is running.



- The countdown appears on the LCD monitor when you press the shutter release button.
- If you press the shutter release button halfway during a countdown, the countdown stops. Press the shutter release button fully to restart the countdown.

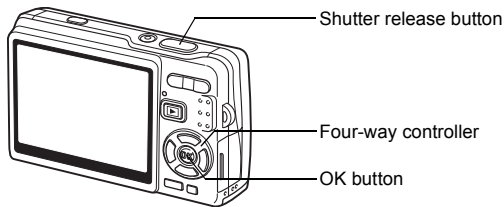

Continuous Shooting (Continuous Shooting Mode)

You can switch the Drive mode to [Continuous Shooting] mode. Pictures are taken continuously while the shutter release button is pressed.

4

Taking Pictures

1 Press the four-way controller (▲) in Capture mode.

2 Press the four-way controller (◀▶) to select  (Continuous Shooting).

3 Press the OK button.

The camera is ready for continuous shooting.

4 Press the shutter release button halfway.



The focus frame on the LCD monitor will light green when the camera is in focus.

5 Press the shutter release button fully.

Pictures are taken continuously while pressing the shutter release button. Shooting stops when you release the shutter release button.



- You can continue shooting until the SD Memory Card or the built-in memory is full.
- The interval will vary depending on the Recorded Pixels and Quality Level settings.
- The interval of continuous shooting may become longer under the following conditions.
 - When Sensitivity is set to 1600
 - When using Intelligent zoom
 - When using Digital SR, Natural Skin Tone, Half-length Portrait, or Night Scene mode
 - When using D-Range Comp.
 - When using the Date Imprint function



- The flash will not discharge in Continuous Shooting mode.
- Continuous shooting is not available in Movie and Frame Composite mode.
- The focus, exposure and white balance are determined in the first frame.

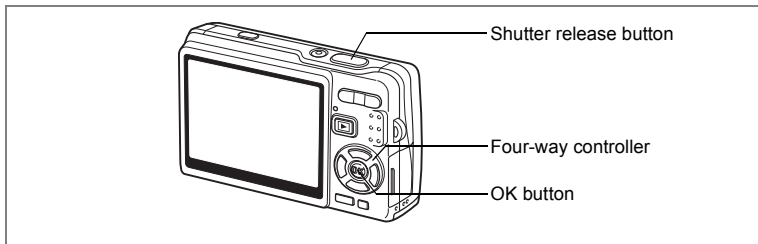

Shooting in Multi-exposure Mode



You can switch the Drive mode to [Multi-exposure Shooting] mode. You can overlap multiple frames while creating a single picture.

- 1 Press the four-way controller (▲) in Capture mode.**
- 2 Press the four-way controller (◀▶) to select  (Multi-exposure).**
- 3 Use the four way controller (▲▼) to specify the number of the picture-shots.**
- 4 Press the OK button.**
- 5 Press the shutter release button halfway.**



- 6 Press the shutter release button fully.**
- 7 Repeat step 5 and 6 for the specified number of picture-shots.**



- When you select , you can use  (2 sec. Self-timer), which enables you to take a picture two seconds after the shutter release button is pressed, or use the Remote Control (optional) to release the shutter, to reduce camera shake and blurring.
- To cancel Multi-exposure shooting halfway, change the Drive mode.



- When you cancel the Multi-exposure shooting before the specified number of picture-shots are taken, the pictures already taken will not be recorded.
- When shooting in Multi-exposure mode, the recorded pixels are fixed to 5M. (When using the Half-length Portrait together with Multi-exposure, the recorded pixels are fixed to 3M.)

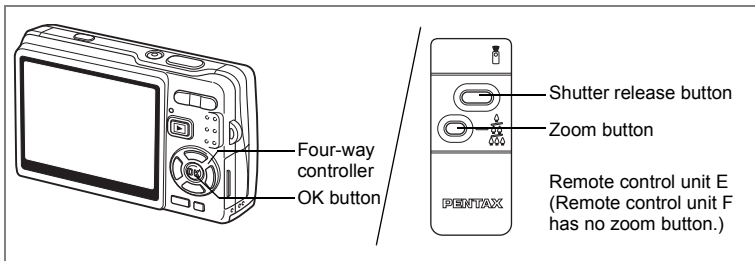

Using the Remote Control Unit (optional)

You can switch the Drive Mode to Remote Control mode to take pictures using the remote control unit E or F (optional).

4

Taking Pictures

Taking Pictures Using the Remote Control

- 1 Press the four-way controller (▲) in Capture mode.
- 2 Press the four-way controller (◀▶) to select (3 sec Remote control) or (0 sec remote control).
- 3 Press the OK button.

The self-timer lamp blinks slowly and the camera is ready for taking pictures.



- 4 Press the shutter release button on the remote control unit.

(3 sec Remote control): The picture is taken after the self-timer lamp blinks quickly for about three seconds.



(0 sec remote control): The picture is taken immediately.





- Focusing may be compromised if you move the camera while the self-timer lamp is blinking.
- You cannot use the remote control unit in Movie mode.

Changing the Magnification Using the Remote Control Unit

You can not only shoot images with the shutter release button, but also change the zoom magnification with the zoom button using the remote control unit E (optional).

- 1 Press the four-way controller (▲) in Capture mode.**
- 2 Press the four-way controller (◀▶) to select  (3 sec Remote control) or .**

The function is same either in  (3 sec Remote control) or  (0 sec remote control).

- 3 Press the zoom button on the remote control unit.**

Each time you press the zoom button, the zoom position will change among tele, middle, and wide.



You cannot change the zoom magnification with the remote control unit in Super Macro mode. You can change it in Macro mode.



- The buttons on the camera can be used in the normal way.
- Be sure that the remote control unit is no more than about four meters away from the front of the camera.
- When operating with the remote control unit, only the optical zoom is available. Digital Zoom and Intelligent Zoom are not available with the remote control unit.

Life of the Battery for the Remote Control Unit

A signal can be sent from the remote control unit to the camera approximately 30,000 times. Contact your nearest PENTAX customer service center if the battery needs replacing. (A charge is made for replacing the battery.)

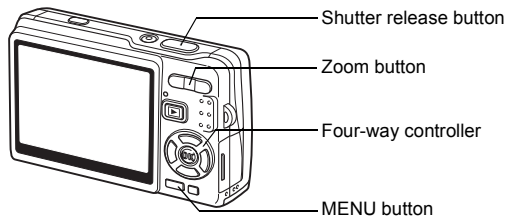

Using Zoom to Change the Subject Size

The camera allows you to zoom in on a distant subject or zoom out to capture a wider view of the subject.

1 Press the zoom button in Capture mode.

Zoom button (⬆️⬆️⬆️) : Diminishes the subject (Wide).

Zoom button (⬆️) : Enlarges the subject (Tele). When you press and hold the button, the camera automatically switches from optical zoom to Intelligent Zoom, and Intelligent Zoom to Digital Zoom.

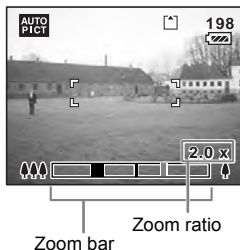

The zoom bar is displayed as follows.

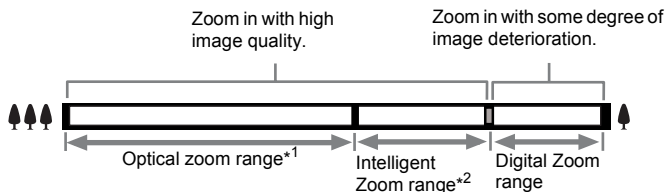

*1 You can zoom in maximum 3× optically.

*2 The Intelligent Zoom range differs depending on the recorded pixels. See the following table.

Recorded pixels and zoom ratio

Recorded pixels	Optical Zoom Range	Intelligent Zoom	Digital Zoom Range
12M	1× to 3×		3.3× to 17.9×
10M	1× to 3×	3.3×	3.9× to 17.9×
7M	1× to 3×	3.3× to 3.9×	4.6× to 17.9×
5M	1× to 3×	3.3× to 4.6×	5.7× to 17.9×
3M	1× to 3×	3.3× to 5.7×	11.4× to 17.9×
1024	1× to 3×	3.3× to 11.4×	13.9× to 17.9×
640	1× to 3×	3.3× to 17.9×	



- Intelligent Zoom is not available under the following conditions.
 - When Digital Zoom is set to Off.
 - When the recorded pixels is 12M. (3× optical zoom available)
 - In Digital SR Mode or Movie mode
- The image enlarged using Intelligent Zoom may appear rough on the LCD monitor. This does not affect the quality of image.
- Only the Digital Zoom is available in Movie mode. Set Movie SR to Off in [📷 Rec.Mode] menu to use the Digital Zoom in Movie mode. (📖 p.109)

Setting the Digital Zoom

The [Digital Zoom] is set to [☑ (On)] by default. To take pictures using only the optical zoom, set the [Digital Zoom] to [☐ (Off)].

1 Press the MENU button in Capture mode.

The [📷 Rec.Mode] menu appears.

2 Use the four-way controller (▲▼) to select [Digital Zoom].

3 Use the four-way controller (◀▶) to select [☑ (On)/☐ (Off)].

4 Press the shutter release button halfway.

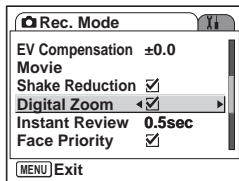

The camera is ready for taking pictures.

Saving the Digital Zoom Function Setting 📖 p.122

Setting the Shooting Functions

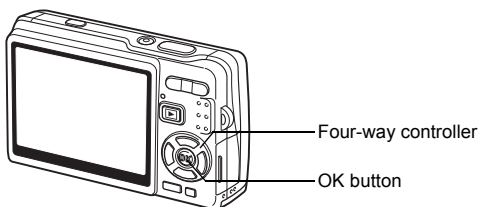





Selecting the Focus Mode

4

Taking Pictures

Focus Mode

AF	Standard (Autofocus mode)	The camera focuses on the object in the autofocus area when the shutter release button is pressed halfway. Use this mode when the distance to the subject is more than approx. 35 cm (16 in.).
	Macro mode	This mode is used when the distance to the subject is approx. 12 cm – 40 cm (4.7 in. – 16 in.). The camera focuses on the object in the autofocus area when the shutter release button is pressed halfway.
	Super Macro mode	This mode is used when the distance to the subject is approx. 6 cm – 15 cm (2.3 in. – 5.9 in.). The camera focuses on the object in the autofocus area when the shutter release button is pressed halfway.
PF	Pan Focus mode	This mode is used when shooting close and distant subjects together or the subject is hard to focus on.
	Infinity mode	This mode is used for taking distant objects.
MF	Manual Focus mode	Adjust the focus manually with the four-way controller.

Saving the Focus Mode  p.122

- 1 Press the four-way controller (▶) in Capture mode.
- 2 Press the four-way controller (▲▼) to select the focus mode.
- 3 Press the OK button.

The camera is ready for taking pictures in the selected focus mode.



Auxiliary AF light

- The auxiliary AF light may be activated under low lighting in Autofocus mode.
- The auxiliary AF light of this camera conforms to the safety standard (IEC60825-1) for Class 1 LED product. Looking at the light directly will not create safety hazard. However, do not look into the emitter from a very short distance since you may feel dazzled.



- The default setting is Standard (Autofocus).
- The zoom is fixed at the full wide-angle in Super Macro mode.
- When Focus Mode is set to Standard (Autofocus), Macro, or Super Macro in Movie mode, the AF operation is performed once just before starting to take the movie.

Manual Focus

In MF (Manual Focus) mode, press the OK button to enlarge the central portion of the image full screen for focus adjustment. Press the four-way controller (▲▼) to adjust the focus while watching the indicator.

- Four-way controller (▲): Focuses farther.
 Four-way controller (▼): Focuses closer.



Indicator

After you determine the focus point, press the OK button to set the focus position and return to the normal capture screen.

Press the four-way controller (▶) to readjust the focus position.



- When focusing, hold down the four-way controller (▲▼) to focus quickly.
- When you use Manual Focus in Movie mode, adjust the focus right before starting taking a movie. You cannot adjust the focus while taking the movie.
- To change Focus Mode from Manual Focus to another one, press the four-way controller (▶) while the indicator is displayed on the LCD monitor.

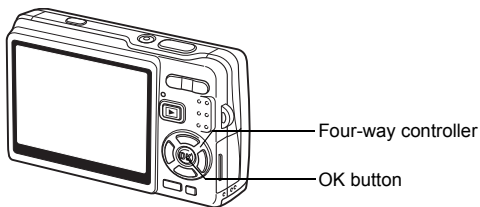

Selecting the Flash Mode

Flash Mode

⚡ _A	Auto	The flash discharges automatically depending on the light conditions.
⚡ _{OFF}	Flash Off	The flash will not discharge, regardless of the brightness. Use this mode to take pictures at dusk or in museums etc. where flash photography is prohibited.
⚡	Flash On	The flash discharges regardless of the brightness.
⦿ _A	Auto + Red-eye	This mode reduces the phenomenon of red eyes caused by the light from the flash being reflected in the subject's eyes. The flash discharges automatically.
⦿ _⚡	Flash On + Red-eye	This mode reduces the phenomenon of red eyes caused by the light from the flash being reflected in the subject's eyes. The flash will discharge regardless of lighting conditions.
SOFT ⚡	Soft Flash	This mode reduces the intensity of the flash so that the flash is not too bright even when fired at close range. The flash will discharge regardless of the light conditions.



- The Flash Mode is fixed to Flash Off under the following conditions.
 - In Movie mode
 - In Continuous Shooting
 - When Focus Mode is set to infinity
- The picture is taken when the last flash is discharged after the pre-flash. (The interval between the flashes is longer when using the red-eye reduction function.)

- 1 Press the four-way controller (◀) in Capture mode.
- 2 Use the four-way controller (▲▼) to select the flash mode.
- 3 Press the OK button.



The camera is ready for taking pictures in the selected flash mode.

Saving the Flash Mode (p.122)

Caution

- Using the flash in Macro mode may cause the image to be overexposed.
- The flash is automatically set to Off in Super Macro mode; however you can still select the desired flash mode.
- Firing the flash in Super Macro mode causes vignetting in the bottom left corner of the image.
- Note that the shutter speed becomes slower when taking pictures with the flash in Night Scene mode.
- When using very slow shutter speeds (taking pictures of night scenes, for example), the Shake Reduction function may not be effective. It is recommended you set Shake Reduction to Off and secure the camera on a tripod or other stable surface to prevent camera shake. (p.110)

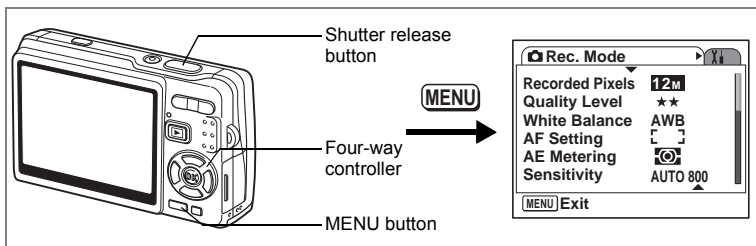

Selecting the Recorded Pixels of Still Pictures

Select the number of the recorded pixels for still images according to how the images will be used.

The larger the number of recorded pixels, the higher the quality of images, but the file size becomes larger. The selected quality level also affects the size of the image file (p.97).

Number of Recorded Pixels

12M (4000×3000)	↑ Clear, Fine	For printing images with high-resolution settings on your printer, printing at A4 size or larger, or editing and processing images	
10M (3648×2736)			
7M (3072×2304)			
5M (2592×1944)			
3M (2048×1536)			For printing at postcard size
1024 (1024×768)			For using as images on websites, or attaching images to e-mails
640 (640×480)			

1 Press the MENU button in Capture mode.

The [Rec.Mode] menu appears.

2 Use the four-way controller (▲▼) to select [Recorded Pixels].

3 Press the four-way controller (▶).

The pull-down menu appears.

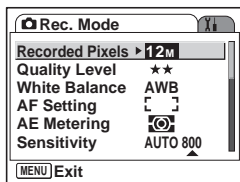

4 Use the four-way controller (▲▼) to change the recording pixels.

The number of shots for the selected recording pixels appears.

5 Press the shutter release button halfway.

The camera is ready for taking pictures.

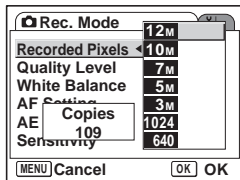

- Selecting a large size produces a clear picture when it is printed out.
- The Recorded Pixels setting is saved when the camera is turned off.
- The Intelligent Zoom range differs depending on the selected recorded pixels. (p.89)

Image Size and Quality of Still Pictures (p.26)

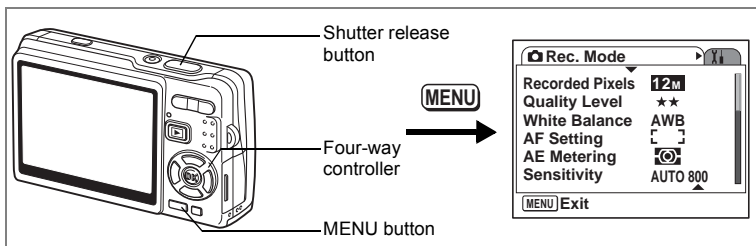

Selecting the Quality Level of Still Pictures

Select the quality (data compression ratio) for still images according to how the images will be used.

The more ★'s, the higher the quality of the image, but the file size becomes larger. The selected recorded pixels also affects the size of the image file (see p.95).

Quality Levels

★★★	Best	Lowest compression ratio. Suitable for photo prints.
★★	Better	Standard compression ratio. Suitable for viewing the image on a computer screen.
★	Good	Highest compression ratio. Suitable for attaching to e-mails or creating websites.

1 Press the MENU button in Capture mode.

The [Rec.Mode] menu appears.

2 Use the four-way controller (▲▼) to select [Quality Level].

3 Press the four-way controller (▶). The pull-down menu appears.

The pull-down menu appears.

4 Use the four-way controller (▲▼) to change the quality level.

The number of shots for the selected quality level appears.

5 Press the shutter release button halfway.

The camera is ready for taking pictures.

The Quality Level setting is saved when the camera is turned off.

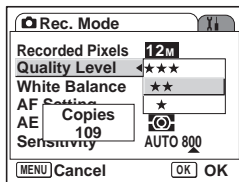
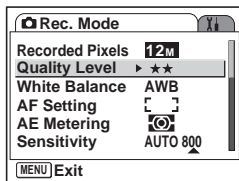

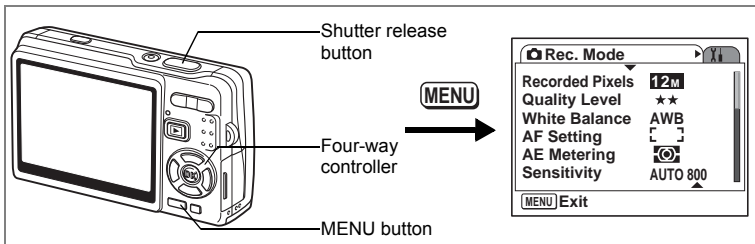

Adjusting the White Balance

The light condition of the shooting location affects the overall color tone of pictures. Adjust the white balance to reproduce the natural color of the subject.

4

White Balance

AWB	Auto	The camera adjusts the white balance automatically.
	Daylight	Use this mode when taking pictures outside in sunlight.
	Shade	Use this mode when taking pictures outside in the shade.
	Tungsten Light	Use this mode when taking pictures under electric or other tungsten light.
	Fluorescent Light	Use this mode when taking pictures under fluorescent light.
	Manual	Adjusts the white balance manually. Use this mode to reproduce colors more accurately or in the shooting locations with mixed light sources.



Set another white balance if you are not satisfied with the color balance of pictures taken with white balance set to AWB (Auto).

- 1 Press the MENU button in Capture mode.**
The [Rec.Mode] menu appears.
- 2 Use the four-way controller (▲▼) to select [White Balance].**
- 3 Press the four-way controller (▶).**
The White Balance screen appears.
- 4 Use the four-way controller (▲▼) to change the setting.**



5 Press the shutter release button halfway.

The camera is ready for taking pictures.

Saving the White Balance  p.122

Manual Setting

Place a white material such as a piece of white paper in front of your camera to adjust white balance.

- 1 **Select  (Manual) on the White Balance screen.**
- 2 **Point the camera at the white material so that it fills the screen.**
- 3 **Press the Green button.**



The white balance is automatically adjusted. [Complete] appears on the LCD monitor.

- 4 **Press the OK button.**

The setting now adjusted is saved and the screen returns to the [ Rec.Mode] menu.

- 5 **Press the shutter release button halfway.**

The camera is ready for taking pictures.

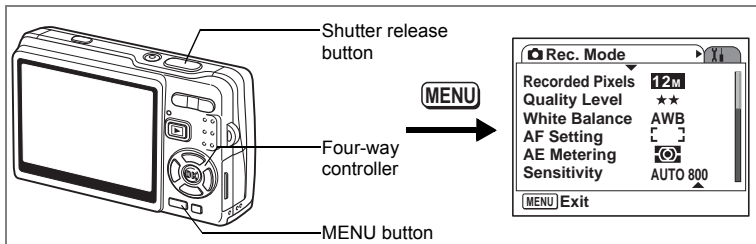

Selecting the Autofocus Settings

You can set the autofocus area and focusing method.

- 1 Press the MENU button in Capture mode.**
The [Rec. Mode] menu appears.
- 2 Use the four-way controller (▲▼) to select [AF Setting].**
- 3 Press the four-way controller (▶).**
The AF Setting screen appears.

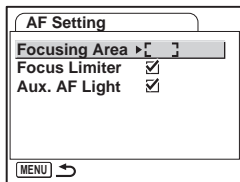

Changing the Focusing Area

You can change the autofocus area (Focusing Area).

Focusing Area

[]	Multiple	The camera measures a wide range in the center of the monitor (within the focusing area) and focuses on the nearest subject.
[]	Spot	The camera measures a narrow range in the center of the monitor (the spot focusing area) making easier for you to focus on a specific subject.
[]	Automatic tracking AF	The camera continues to focus on the moving subject while you are pressing the shutter release button halfway.

4 Press the four-way controller (▶).

The pull-down menu appears.

5 Use the four-way controller (▲▼) to change the Focusing Area.

6 Press the shutter release button halfway.

The camera is ready for taking pictures.

Saving the Focusing Area Setting p.122

Setting the Focus Limiter

You can limit the focusing range of the lens in accordance with the shooting conditions.

When you set the [Focus Limiter] to [On], the focusing range of the lens is limited to the long range side for normal shooting, and to the close-up side for macro shooting. You can adjust the focus on the subject quickly.

4 Use the four-way controller (▲▼) to select [Focus Limiter].

5 Use the four-way controller (◀▶) to select [(On)/ (Off)].

6 Press the shutter release button halfway.

The camera is ready for taking pictures.

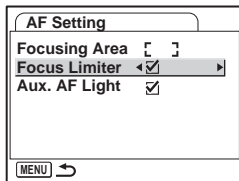

Setting the Auxiliary AF Light

The auxiliary AF light is convenient when you shoot a dark subject. This helps you to focus on the subject under the conditions that the auto focus does not work properly.

- 4 Use the four-way controller (▲▼) to select [Aux. AF Light].**
- 5 Use the four-way controller (◀▶) to select [(On)/ (Off)].**
- 6 Press the shutter release button halfway.**

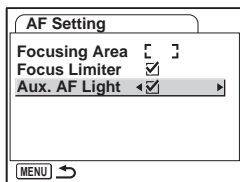

The camera is ready for taking pictures.

4



The auxiliary AF light of this camera conforms to the safety standard (IEC60825-1) for Class 1 LED product. Looking at the light directly will not create safety hazard. However, do not look into the emitter from a very short distance since you may feel dazzled.



The camera does not emit the AF light under the following conditions.

- In Movie mode
- In Landscape mode (The AF light is available if you set Aux. AF Light to On.)
- When Focus Mode is set to Pan Focus, Infinity or Manual Focus.
- When Focusing Area is set to Automatic tracking AF.

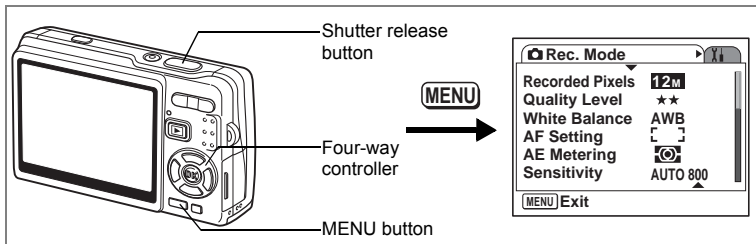

Setting the Light Metering Mode to Determine the Exposure

You can select which part of the screen to use to measure the brightness and determine the exposure.

AE Metering Modes

	Multi-segment	The exposure is determined by the entire screen.
	Center-weighted	The exposure is determined mainly by the center of the screen.
	Spot	The exposure is determined by the small area in the center of the screen only.

1 Press the MENU button in Capture mode.

The [Rec.Mode] menu appears.

2 Use the four-way controller (▲▼) to select [AE Metering].

3 Press the four-way controller (▶).

The pull-down menu appears.

4 Use the four-way controller (▲▼) to change the AE metering mode.

5 Press the shutter release button halfway.

The camera is ready for taking pictures.

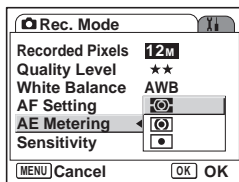
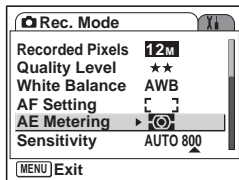

Saving the AE Metering Mode p.122



In Shutter Priority mode and Manual mode, Multi-segment cannot be selected.

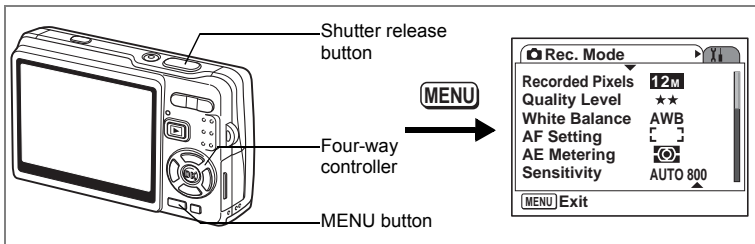

Setting the Sensitivity

Sensitivity (ISO sensitivity) is a value indicating how sensitive the CCD is to light. Low value equals low sensitivity, and high value equals high sensitivity. Sensitivity can be adjusted according to the shooting situations.

Sensitivity

AUTO	AUTO800 (50 - 800) is selected by default. You can also set ISO Correction in AUTO to 50 - 100, 50 - 200, 50 - 400, 50 - 800 or 50 - 1600. (In Digital SR mode, AUTO1600 (50 - 1600) is selected by default. The setting up to 50-3200 is selectable.)
50	 <p>At a lower sensitivity, images are sharper and noise is reduced, but the shutter speed will be slower under dark conditions. At a higher sensitivity, the shutter speed will be higher, but image noise will increase. (In Digital SR mode, 3200 is also selectable.)</p>
100	
200	
400	
800	
1600	

1 Press the MENU button in Capture mode.

The [📷 Rec.Mode] menu appears.

2 Use the four-way controller (▲▼) to select [Sensitivity].

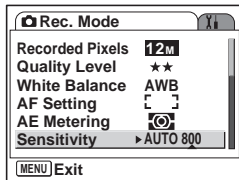

3 Press the four-way controller (▶).

The pull-down menu appears.

4 Use the four-way controller (▲▼) to select the sensitivity.

To show [1600] ([1600] and [3200] in Digital SR mode) on the pull-down menu, press the four-way controller (▼) when [800] is highlighted.

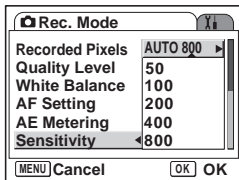

Selecting the Sensitivity Other Than in ISO Correction Range

5 Press the shutter release button halfway.

The camera is ready for taking pictures.

Selecting the Sensitivity and ISO Correction Range

5 Select [AUTO] and press the four-way controller (▶).

The ISO Correction in AUTO range selection screen appears.

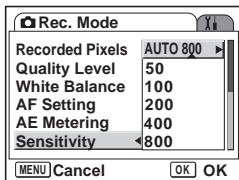

6 Press the four-way controller (▲▼◀▶) to select a range.

7 Press the shutter release button halfway.

The camera is ready for taking pictures.

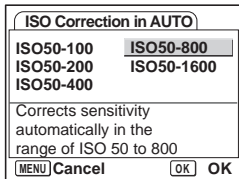

Saving the Sensitivity p.122



- The sensitivity for Movie mode is fixed to AUTO. The setting cannot be changed.
- The sensitivity for Shutter Priority mode is fixed to AUTO800. The setting cannot be changed.
- In Manual Exposure mode, AUTO cannot be selected.
- Even if you set Sensitivity to Off in Memory, the selected range for ISO Correction in AUTO is saved when the camera is turned off. The selected sensitivity will be saved only when you set Sensitivity to On in Memory.

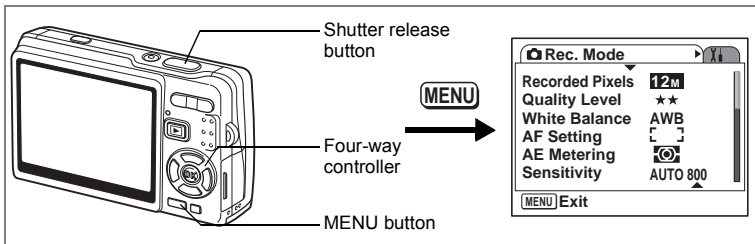

Setting the Exposure (EV Compensation)

The overall brightness of pictures can be changed by adjusting the EV compensation value (amount of light that the CCD receives). This changes the exposure automatically determined by the camera when you want to adjust the brightness of pictures to suite your taste.

4

Taking Pictures

1 Press the MENU button in Capture mode.

The [Rec.Mode] menu appears.

2 Use the four-way controller (▲▼) to select [EV Compensation].

3 Use the four-way controller (◀▶) to change the EV setting.

+: Brightens the picture (overexposed).

-: Darkens the picture (underexposed).

You can select the EV setting in the range of -2.0 EV to +2.0 EV in 1/3 EV steps.

4 Press the shutter release button halfway.

The camera is ready for taking pictures.

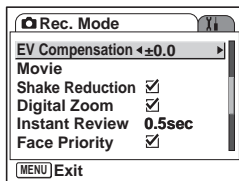

Saving the EV Compensation Value p.122



In Auto Picture mode, the exposure is fixed to ±0.0.

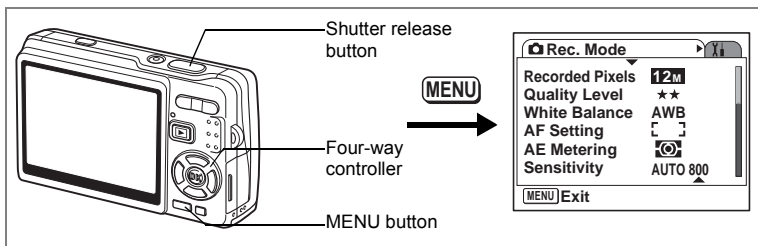

Selecting the Settings for Taking Movies

You can select the recorded pixels and quality level for taking movies.

1 Press the MENU button in Capture mode.

The [Rec. Mode] menu appears.

2 Use the four-way controller (▲▼) to select [Movie].

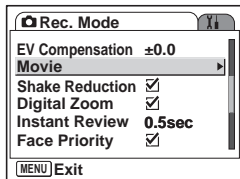

3 Press the four-way controller (▶).

The Movie setting menu appears.

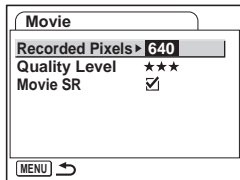

Selecting the Recorded Pixels of Movies

You can select the number of recorded pixels at [640 (640×480)] or [320 (320×240)]. The more pixels are selected, the larger the file size. The file size also varies depending on the quality level setting.

Recorded Pixels

640 (640×480)	You can view high-quality movies at VGA size. The recordable time is shorter.
320 (320×240)	The file size is smaller and the recordable time is longer.

4 Press the four-way controller (▶).

The pull-down menu appears.

5 Use the four-way controller (▲▼) to select [Recorded Pixels].

The recordable time for the selected recorded pixels appears.

6 Press the shutter release button halfway.

The camera is ready for taking pictures.

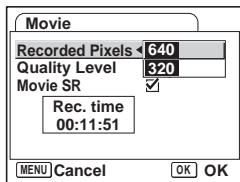

Size and Quality of Movies p.27

Selecting the Quality Level of Movies

You can select the quality level from [★★★(Best)], [★★(Better)] and [★(Good)]. The more ★'s, the clearer the movie appears and the larger the file size.

4 Use the four-way controller (▲▼) to select [Quality Level].

5 Press the four-way controller (▶).

The pull-down menu appears.

6 Use the four-way controller (▲▼) to select a desired quality level.

The recordable time for the selected quality level appears.

7 Press the shutter release button halfway.

The camera is ready for taking pictures.

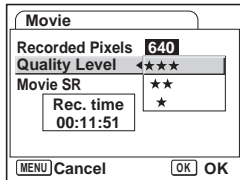
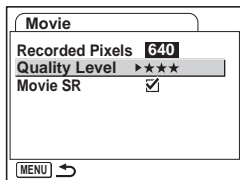

Size and Quality of Movies p.27

Compensating for Camera Shake While Taking Movies (Movie SR)

When you set [Movie SR] to [(On)], the movie-anti shake function is activated. It automatically compensates for image blur to allow you to take smooth movies.

- 4 Use the four-way controller (▲▼) to select [Movie SR].**
- 5 Use the four-way controller (◀▶) to select [(On)] or [(Off)].**

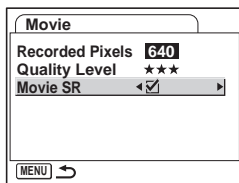

Set Movie SR to Off to use Digital Zoom while taking movies.

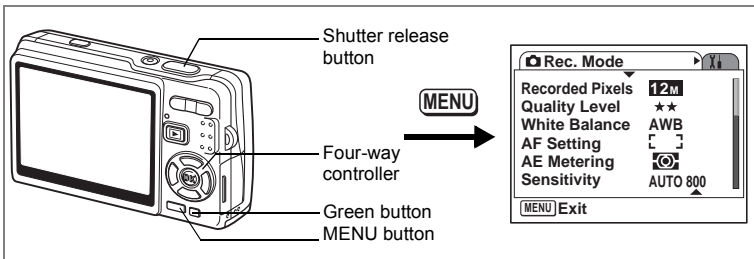

Setting the Shake Reduction Function for Still Images to On

4

Taking Pictures

Set [Shake Reduction] in [Rec. Mode] menu to [On] to use the Shake Reduction function for still images. For details on the function, see p.57.

1 Press the MENU button in Capture mode.

The [Rec. Mode] menu appears.

2 Use the four-way controller (▲▼) to select [Shake Reduction].

3 Use the four-way controller (◀▶) to select [On/Off].

(On): (Shake Reduction On) appears on the LCD monitor when you press the shutter release button halfway.

(Off): (Shake Reduction Off) is always displayed on the LCD monitor.

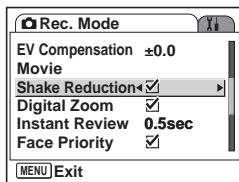

4 Press the shutter release button halfway.

The camera is ready for taking pictures.



You can also select On/Off using the Green button. This function cannot be used when assigning a function other than Shake Reduction to the Green button. (p.115)

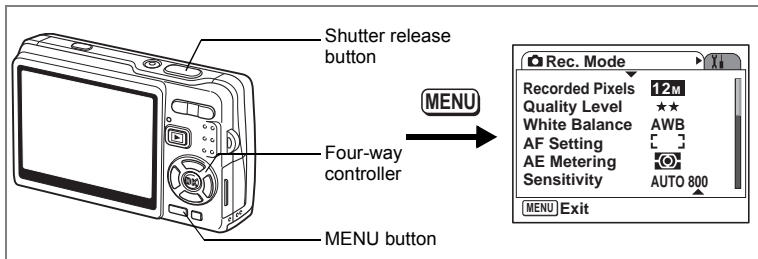

Setting the Instant Review Time

You can select the Instant Review time from [Off (no display)], [0.5 sec.], [1 sec.], [2 sec.], [3 sec.] and [5 sec.].

1 Press the MENU button in Capture mode.

The [Rec.Mode] menu appears.

2 Use the four-way controller (▲▼) to select [Instant Review].

3 Press the four-way controller (▶).

The pull-down menu appears.

4 Use the four-way controller (▲▼) to change the display time.

5 Press the shutter release button halfway.

The camera is ready for taking pictures.

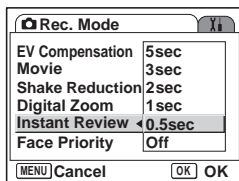
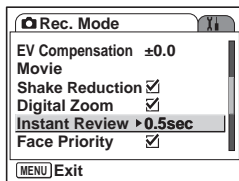

The Instant Review setting is saved when the camera is turned off.

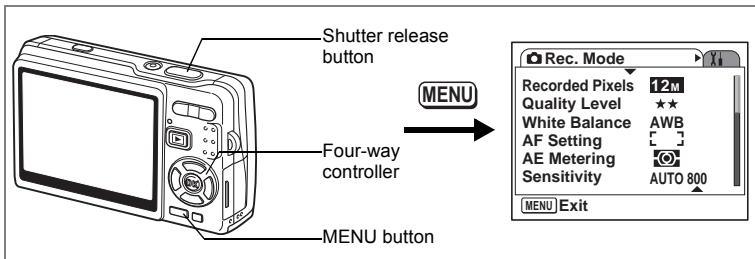

Setting the Face Priority to On

Set the [Face Priority] in the [📷 Rec.Mode] menu to On to use the Face Priority function.

“Face Recognition AF” and “Face Recognition AE” are activated. When you point the camera at your subject’s face, the camera automatically recognizes it, adjusting both focus and exposure.

1 Press the MENU button in Capture mode.

The [📷 Rec. Mode] menu appears.

2 Use the four-way controller (▲▼) to select [Face Priority].

3 Use the four-way controller (◀▶) to select [(On)]/□ (Off).

(On) : (Face Priority On) appears on the LCD monitor when you press the shutter release button halfway.

(Off) : (Face Priority Off) is always displayed on the LCD monitor.

4 Press the shutter release button halfway.

The camera is ready for taking pictures.

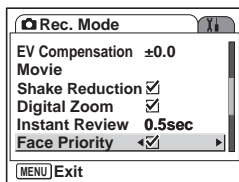

- When the Face Priority is set to On, the Face Recognition function will work regardless of the shooting mode.
- “Face Recognition AF” and “Face Recognition AE” may not work if the subject’s face is partly covered, for example, with sunglasses, or when the subject does not face the camera.

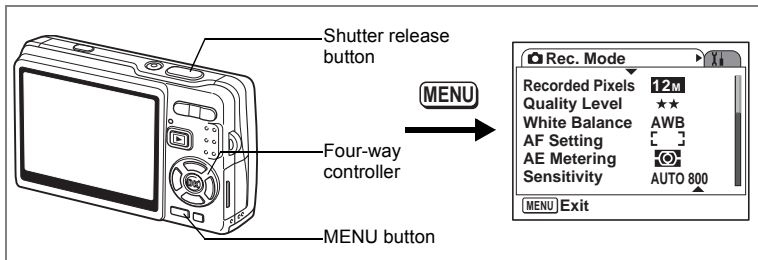

Setting the D-Range Compensation

You can select the [D-Range Comp.] setting (making dark portions brighter while keeping the exposure level for the entire image) from [Off (no display)], [Weak], [Strong] and [Auto].

1 Press the MENU button in Capture mode.

The [📷 Rec. Mode] menu appears.

2 Use the four-way controller (▲▼) to select [D-Range Comp.].

3 Press the four-way controller (▶).

The pull-down menu appears.

4 Use the four-way controller (▲▼) to change the setting.

5 Press the shutter release button halfway.

The camera is ready for taking pictures.

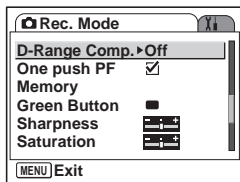

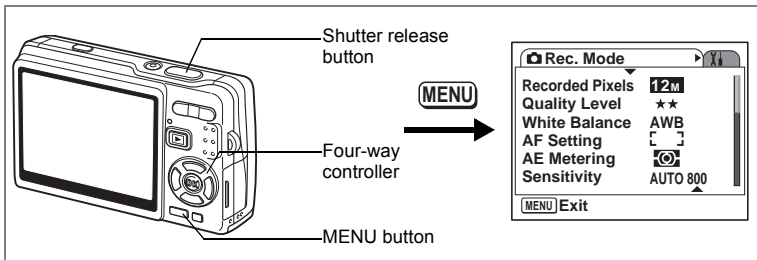

Setting the One push PF function to On

You can press the shutter release button all the way down (single step) without pressing the button halfway to shorten the shutter delay. Set the “One push PF” in the [📷 Rec.Mode] menu to on to use the One push PF function.

The One push PF function allows you to release the shutter at the right moment. The pictures are taken as deep-focus (pan focus) shots.

1 Press the MENU button in Capture mode.

The [📷 Rec. Mode] menu appears.

2 Use the four-way controller (▲▼) to select [One push PF].

3 Use the four-way controller (◀▶) to select [(On)/ (Off)].

The camera is ready for taking pictures.

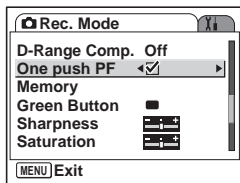

The One push PF function works only when Focus Mode is Standard (Autofocus) and One push PF in the [📷 Rec.Mode] menu is set to On.

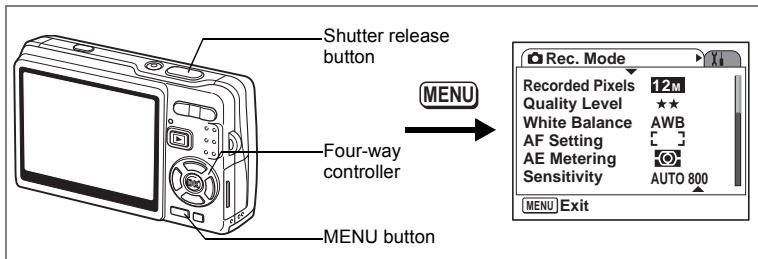

Setting the Green Button

You can assign one of the following functions to the Green button; [Green Mode] (p.59), [Face Priority] (p.112), [D-Range Comp.] (p.113), [Shake Reduction] (p.57), and [Fn Setting] (p.116). You can activate the assigned function by just pressing the Green button.

Assigning a Function (Green Mode/Face Priority/D-Range Comp./Shake Reduction)

1 Press the MENU button in Capture mode.

The [Rec.Mode] menu appears.

2 Press the four-way controller (▲▼) to select [Green Button].

3 Press the four-way controller (▶).

The Green button setting screen appears.

4 Use the four-way controller (▲▼) to select the function you want to register.

5 Press the shutter release button halfway.

The camera is ready for taking pictures.

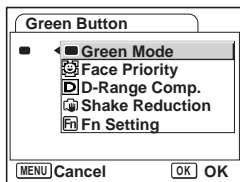
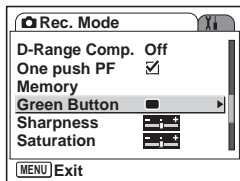

Green Mode is registered as the default setting.

Registering Frequently Used Functions (Fn Setting)

You can register frequently used functions on the four-way controller. Using this function, you can directly set the functions by pressing the four-way controller without displaying the menu in Capture mode. In [Fn Setting], still picture mode and Movie mode have different settings. To execute [Fn Setting] for Movie mode, press MENU button in Movie mode in Step 1 on page 115.

4 Use the four-way controller (▲▼) to select [Fn Setting].

5 Press the OK button.

The Fn Setting screen appears.

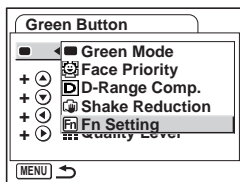

6 Use the four-way controller (▲▼) to select a key you want to assign a function to.

7 Press the four-way controller (▶).

The pull-down menu appears.

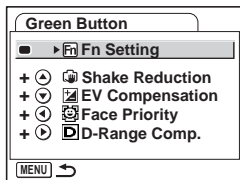

8 Use the four-way controller (▲▼) to select a function you want to assign.

9 Press the OK button.

10 Press the shutter release button halfway.

The camera is ready for taking pictures.

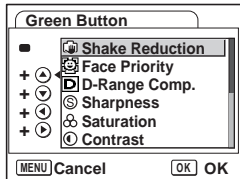

This function is activated only when you assign the Fn Setting to the Green button.



You can assign only one function to each key.

The initial settings for Fn Setting

	Still picture mode	Movie mode
Initial settings	(▲) Shake Reduction	(▲) Movie SR
	(▼) EV Compensation	(▼) EV Compensation
	(◀) Face Priority	(◀) Face Priority
	(▶) D-Range Comp.	(▶) Quality Level

Functions that can be registered on Fn Setting

	Still picture mode	Movie mode
Setting items	Recorded Pixels	Recorded Pixels
	Quality Level	Quality Level
	White Balance	Movie SR
	AE Metering	White Balance
	Sensitivity	EV Compensation
	EV Compensation	Face Priority
	Shake Reduction	Sharpness
	Face Priority	Saturation
	D-Range Comp.	Contrast
	Sharpness	
	Saturation	
	Contrast	

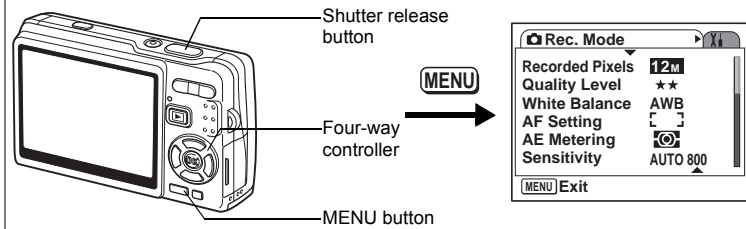

Setting the Image Sharpness

You can select whether you want the image to have sharp or soft outlines.

4

Taking Pictures

1 Press the MENU button in Capture mode.

The [📷 Rec.Mode] menu appears.

2 Use the four-way controller (▲▼) to select [Sharpness].

3 Use the four-way controller (◀▶) to adjust sharpness.

-: Softens the contours.

+: Sharpens the contours.

4 Press the shutter release button halfway.

The camera is ready for taking pictures.

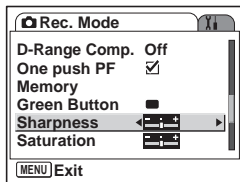

The Sharpness setting is saved when the camera is turned off.

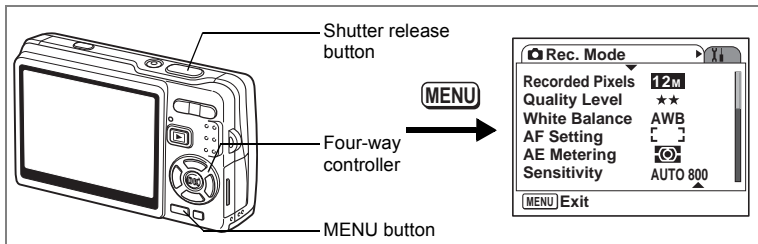

Setting the Color Saturation

You can set the color saturation.

1 Press the MENU button in Capture mode.

The [📷 Rec.Mode] menu appears.

2 Use the four-way controller (▲▼) to select [Saturation].

3 Use the four-way controller (◀▶) to adjust saturation.

–: Reduces the saturation.

+ : Increases the saturation.

4 Press the shutter release button halfway.

The camera is ready for taking pictures.

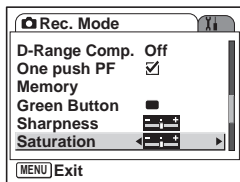

The Saturation setting is saved when the camera is turned off.

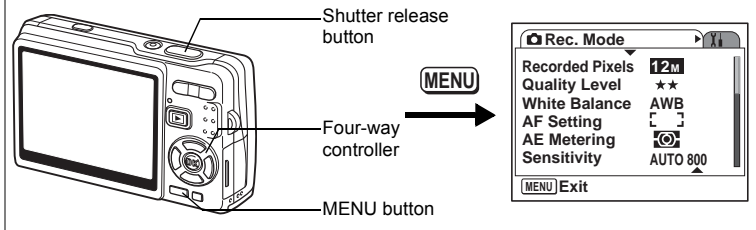

Setting the Image Contrast

You can set the image contrast.

1 Press the **MENU** button in Capture mode.

The [📷 Rec.Mode] menu appears.

2 Use the four-way controller (▲▼) to select [Contrast].

3 Use the four-way controller (◀▶) to adjust contrast.

-: Reduces the contrast.

+: Increases the contrast.

4 Press the shutter release button halfway.

The camera is ready for taking pictures.

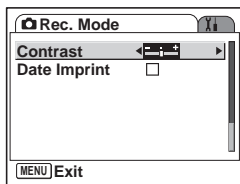

The Contrast setting is saved when the camera is turned off.

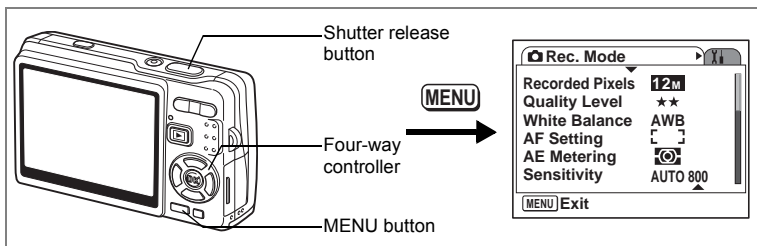

Setting the Date Imprint

Set the date to be imprinted on your pictures.

- 1 Press the MENU button in Capture mode.**
The [📷 Rec. Mode] menu appears.
- 2 Use the four-way controller (▲ ▼) to select [Date Imprint].**
- 3 Use the four-way controller (◀ ▶) to select [(On)/ (Off)].**
- 4 Press the shutter release button halfway.**

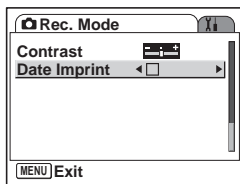

The camera is ready for taking pictures.



The imprinted date is part of the recorded image. You cannot remove it from the recorded image.

Saving the Settings

Saving the Menu Items (Memory)

You can save the settings for the menus after turning off the camera (Memory function).









Select [On] to save the setting for the menu items after turning off the camera.

Select [Off] to reset the setting for the menu items to the default after turning off the camera.

You can set [On] or [Off] to each menu item listed below.

4

The menu items for Memory

Item	Description	Default Setting
Flash Mode	The flash mode setting on the  button is saved.	<input checked="" type="checkbox"/>
Drive Mode	The drive mode setting ( , etc.) selected using the four-way controller () is saved.	<input type="checkbox"/>
Focus Mode	The focus mode setting on the  button is saved.	<input type="checkbox"/>
Zoom Position	The optical zoom position setting on the zoom button is saved.	<input type="checkbox"/>
MF Position	The manual focus position is saved.	<input type="checkbox"/>
White Balance	The [White Balance] setting on the [ Rec.Mode] menu is saved.	<input type="checkbox"/>
AE Metering	The [AE Metering] setting on the [ Rec.Mode] menu is saved.	<input type="checkbox"/>
Sensitivity	The [Sensitivity] setting on the [ Rec.Mode] menu is saved.	<input type="checkbox"/>
EV Compensation	The [EV Compensation] setting on the [ Rec.Mode] menu is saved.	<input type="checkbox"/>
Digital Zoom	The [Digital Zoom] setting (On/Off) on the [ Rec.Mode] menu is saved.	<input checked="" type="checkbox"/>
DISPLAY	The LCD monitor display mode is saved.	<input type="checkbox"/>
File #	The file number is saved. Even when a new SD Memory Card is inserted, file numbers are assigned sequentially.	<input checked="" type="checkbox"/>



- The current zoom position in Intelligent Zoom or Digital Zoom will not be saved even if you set Zoom Position to On in Memory. Only the current zoom position in the optical zoom can be saved.
- Even if you set Sensitivity to Off in Memory, the selected range for ISO Correction in AUTO is saved when the camera is turned off.
- When “File #” is set to On, the file number of the last image taken will be saved, and the file number will continue even after inserting a new SD Memory card. Also, the file number will continue even after inserting an SD Memory card with images already recorded on it.
- When “File #” is set to Off, the file number of the image will start from the lowest number each time a new SD Memory card is inserted. The file number will continue after an SD Memory card with images already recorded on it.

1 Press the MENU button in Capture mode.

The [📷 Rec.Mode] menu appears.

2 Use the four-way controller (▲▼) to select [Memory].

3 Press the four-way controller (▶).

The menu items screen appears.

4 Use the four-way controller (▲▼) to select an item.

5 Use the four-way controller (◀▶) to select [(On)/ (Off)].

6 Press the shutter release button halfway.

The camera is ready for taking pictures.

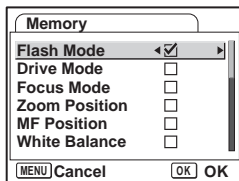
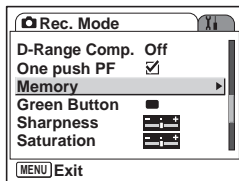

Recording Sound (Voice Recording Mode)

You can record sound. The recordable time appears on the LCD monitor according to how much space is available on the SD Memory Card.

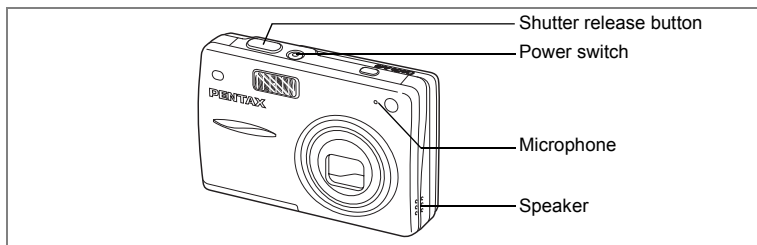

1 Press the four-way controller (▼) in Capture mode.

The Mode Palette appears.

2 Use the four-way controller (▲▼◀▶) to select (Voice Recording).

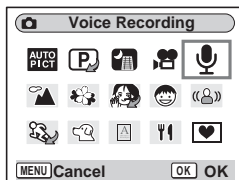

3 Press the OK button.

The recordable time appears on the LCD monitor.

- 1 Remaining recordable time
- 2 Recording time



4 Press the shutter release button.

Recording starts. The access lamp lights during recording.

When the shutter release button is pressed for more than one second, recording continues for as long as the button is held down and stops when the button is released.

5 Press the shutter release button.

Recording stops. The remaining recordable time appears.

6 Press the four-way controller (▼) to display Mode Palette and change to another mode.

You can exit the Voice Recording mode.





- Sound is saved in WAVE monaural files.
- The microphone is located on the front of the camera. Aim the camera to obtain the best sound.
- An index can be added by pressing the MENU button during recording.
- You can record sound for a maximum of 24 consecutive hours on a high-capacity SD Memory card.

Playing Back Sound

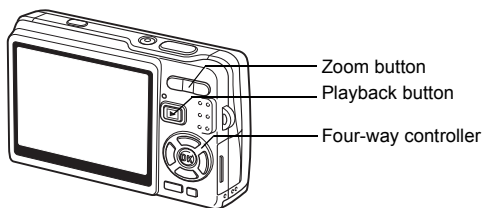
You can play back the recording you made in Voice Recording mode.



- 1 Press the  Playback button in the Voice Recording mode.**
- 2 Use the four-way controller ( ) to select the recording to play back.**

- 3 Press the four-way controller ().**

Playback starts.

Four-way controller (): Pauses playback.
Press again to restart playback.

If there are no recorded indexes:

Four-way controller (): Rewinds about five seconds.

Four-way controller (): Advances about five seconds.

If there are recorded indexes:

Four-way controller (): Plays back starting from the previous index.

Four-way controller (): Plays back starting from the next index.

Zoom button (): Increases the volume.

Zoom button (): Reduces the volume.

- 4 Press the four-way controller ().**

Playback stops.



Length of recording

Adding a Voice Memo

You can add a voice memo to a captured image.

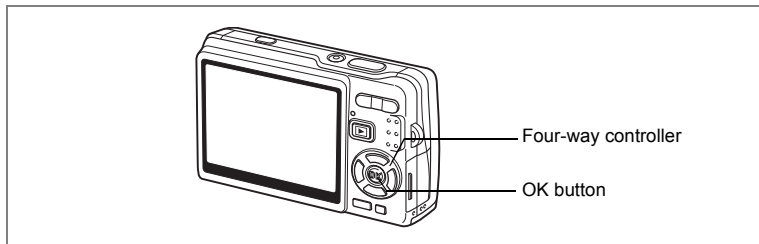

Recording a Voice Memo

1 Enter the Playback mode and use the four-way controller (◀▶) to select the image to which you want to add a voice memo.

2 Press the four-way controller (▼).
The Mode Palette appears.

3 Use the four-way controller (▲▼◀▶) to select  (Voice Memo).

4 Press the OK button.
Recording starts. You can record for up to 30 seconds.

5 Press the OK button.
Recording stops.

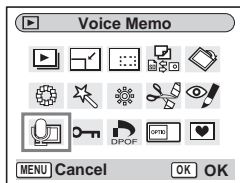

-  appears on the screen when a voice memo is added.
- A voice memo cannot be added to an image which already has a voice memo. Delete the old voice memo and record a new one. (p.138)



A voice memo cannot be added to protected (Ⓞ) images.

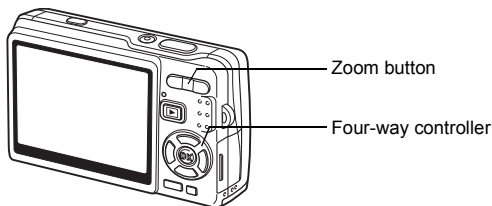

Playing Back a Voice Memo

- 1 Enter the Playback mode and use the four-way controller (◀▶) to select the still picture with the voice memo that you want to play back.**

If  appears on the displayed image, a voice memo has been recorded.



- 2 Press the four-way controller (▲).**
Playback starts.
Zoom button (▲) : Increases the volume.
Zoom button (▼) : Reduces the volume.
- 3 Press the four-way controller (▼).**
Playback stops.

Deleting Voice Memos Only  p.138

Playing Back Images

You can enjoy playback of images saved on the SD Memory Card and the built-in memory.

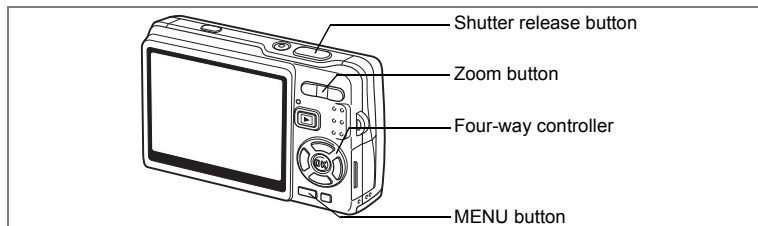

Playing Back Still Pictures

Press the Playback button.

When an SD Memory Card is installed

appears in the upper right corner of the LCD monitor and the images recorded on the SD Memory Card are played back.

When no SD Memory Card is installed

appears in the upper right corner of the LCD monitor and the images recorded in the built-in memory are played back.

Refer to "Playing Back an Image" (p.37), or "Playing Back the Previous or Next Image" (p.37) for instructions on playing back images.

Zoom Display

You can display images magnified up to eight times.

- 1 Enter the Playback mode and use the four-way controller (◀▶) to select the image to magnify.**
- 2 Press / on the zoom button.**

Each time you press the button, the zoom scaling changes as follows: 1.3x, 2.0x, 2.6x, 4.0x, 5.3x, 8.0x. You can use the guide at the bottom left of the screen to check which portion of the image is magnified.

Four-way controller (▲▼◀▶): Moves the position for magnification.

Zoom button (▲)

Zoom button (◆◆◆)

: Enlarges the image.

: Diminishes the image.



Guide

3 Press the MENU button.

Zoom playback ends.

Setting the Quick Zoom Function

You can display the image at maximum magnification simply by pressing \blacktriangle/Q on the zoom button once during zoom playback.

1 Press the MENU button.

The [ Rec.Mode] menu appears.

2 Press the four-way controller (▶).

3 Use the four-way controller (▲▼) to select [Quick Zoom].

4 Use the four-way controller (◀▶) to select [(On)/ (Off)].

5 Press the shutter release button halfway.

The camera is ready for taking pictures.

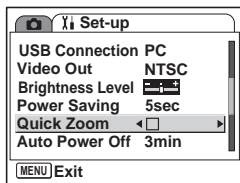

Calling Up the Images from the Built-in Memory

If you store your favorite images and sounds in the built-in memory, you can play them anytime you wish. (My album function)

You can call them up from the built-in memory with the SD Memory Card installed in the camera.

1 With the SD Memory Card installed, hold down the Playback button for more than 4 seconds in Capture mode.

The lens retracts two seconds after you press the  button. The images and sounds in the built-in memory are played back after two more seconds.



- You can play back "my album" in the same way as you play back images and sounds recorded on the SD Memory Card.
- Stop the playback of "my album" to do the following.
 - To play back the images on the SD Memory Card.
 - To copy files between the SD Memory Card and the built-in memory.
 - To format an SD Memory Card or the built-in memory.
- To stop the playback of "my album", do either of the followings.
 - Press the  Playback button or press the shutter release button halfway. The camera returns to the Capture mode.
 - Turn off the camera.

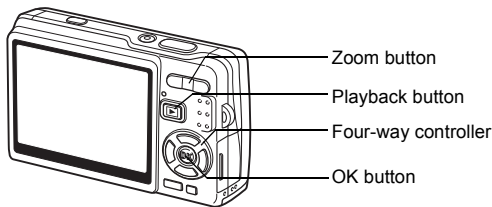

Playing Back Movies

You can play back movies (with the sounds). A guide to operation appears on the LCD monitor during playback. Operations include playback, frame by frame playback (forward or reverse), pause and volume adjustment.

1 Enter the Playback mode and use the four-way controller (◀▶) to select the movie to play back.

2 Press the four-way controller (▲).

Playback starts.

- **The following operations can be performed during playback.**

Four-way controller (◀): Plays back in fast rewind.

Four-way controller (▶): Plays back in fast forward.

Four-way controller (▲): Pauses the movie.

OK button : Changes the display mode. (p.132)

Zoom button (⏏/⏏) : Adjusts the volume.

- **The following operations can be performed during pause.**

Four-way controller (◀): Reverses the movie frame by frame.

Four-way controller (▶): Advances the movie frame by frame.

Four-way controller (▲): Restarts playback.

OK button : Changes the display mode. (p.132)



3 Press the four-way controller (▼).

Playback stops and the screen returns to the first frame.

4 Press the [▶] Playback button.

The camera returns to Capture mode.



No sound is output during fast-rewind and fast-forward playback.

Displaying Shooting Information in Playback Mode

In the Playback mode, press the OK/Display button to switch the “display modes”. There are 3 display modes for the Playback mode.

Normal Display

Shooting information is displayed.

- 1 Voice Memo icon
- 2 Card/Built-in memory icon
- 3 Folder name
- 4 File name
- 5 Protect icon
- 6 Battery indicator
- 7 Shooting date and time
- 8 Four-way controller operation guide



Histogram Display

The brightness distribution of the image is displayed. The horizontal axis shows the brightness (darkest at the left end and brightest at the right end) and the vertical axis shows the number of pixels.

- 1 Recorded pixels
- 2 Quality level
- 3 White balance
- 4 AE metering
- 5 Sensitivity
- 6 Histogram
- 7 Aperture
- 8 Shutter speed

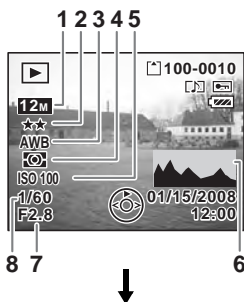

No icons

No shooting information is displayed.

Saving the Display Mode ☞ p.122

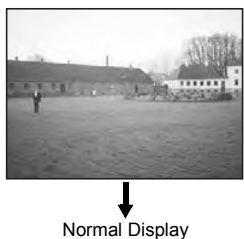

- If you press and hold the OK/Display button for more than 1 second, the LCD Bright Mode is activated. The LCD monitor turns brighter for a certain amount of time. (☞ p.37)
- The histogram display is not available while playing back movies.

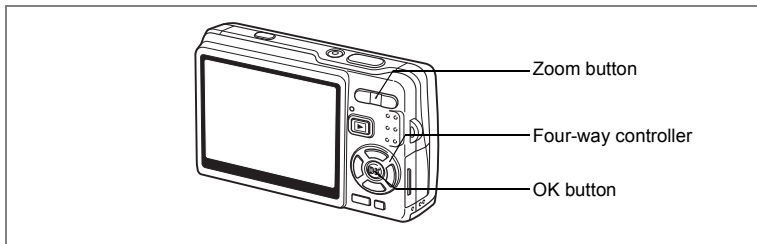

Nine-Image Display/Calendar Display

Nine-Image Display

You can display nine images at the same time.

1 Enter the Playback mode and use the four-way controller (◀▶) to select an image.

2 Press ▲▲▲/☒ on the zoom button.

Nine thumbnails of images are displayed at a time. The thumbnails change nine at a time, page by page.

Four-way controller (▲▼◀▶) : Moves the frame.

Four-way controller (◀) : Displays the previous page when the frame is on the upper-left image. (Available only when ten or more files are saved.)

Four-way controller (▶) : Displays the next page when the frame is on the lower-right image. (Available only when ten or more files are saved.)

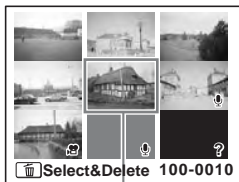

Selected image

The icons that appear on the images indicate the following:

- No icon : Still picture without voice memo
- 🎤 (with image) : Still picture with voice memo
- 🎬 : Movie (The first frame of the movie is shown.)
- 🎤 (without image) : Sound file only
- ❓ : Undisplayable image

3 Press the OK button.

The selected image is displayed full screen.



You can also display the selected image full screen by pressing the MENU button or ▲/Q on the zoom button in Step 3.

Calendar Display

In calendar display, the recorded images and sound files are displayed by date in calendar format. You can select images by date of shooting/recording.

1 In Playback mode, press on the zoom button.

Nine thumbnails of images appear.





2 Press on the zoom button.

The nine-image display changes to the calendar display.

3 Use the four-way controller () to select a desired date on the calendar.

SUN	MON	TUE	WED	THU	FRI	SAT
		1	2	3	4	5
6	7	8	9	10	11	12
13	14	15	16	17	18	19
20	21	22	23	24	25	26
27	28	29	30	31		

2008.01

Four-way controller (   ) : Moves the frame on the calendar.

Selected date

Four-way controller (): When the frame is on the first day of the month, goes back to the previous month.

Four-way controller (): When the frame is on the last day of the month, goes to the next month.

4 Press the OK button or on the zoom button.

OK button : Displays the first image recorded on the selected date full screen.

Zoom button (): Displays the images recorded on the selected date in nine-image display.



-  appears on the date on which a sound file (without image) was the first item recorded. The first frame of the movie appears on the date on which movie was the first item recorded.
- Press the MENU button in calendar display to return to the previous nine-image display.

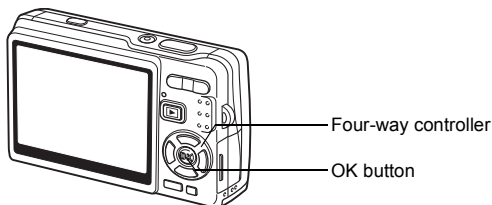

Slideshow

You can play back all the images on the SD Memory Card or in the built-in memory continuously.

- 1** Enter the Playback mode and use the four-way controller (◀▶) to select the image with which to start the slideshow.
- 2** Press the four-way controller (▼).
The Mode Palette appears.
- 3** Use the four-way controller (▲▼◀▶) to select  (Slideshow).
- 4** Press the OK button.
- 5** Use the four-way controller (◀▶) to change the playback interval.
Select from the following: [3 sec], [5 sec], [10 sec], [20 sec], [30 sec].
- 6** Use the four-way controller (▼) to select [Screen Effect].

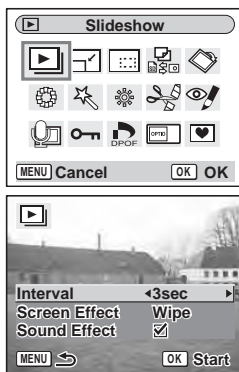

7 Use the four-way controller (◀▶) to select the effect.

Wipe	The effect is like a slide show that slides the displayed images one by one to the left.
Fade	The current image gradually disappears and the next image appears under it.
Shrink	The current image shrinks towards the center.
Off	No screen effect.

8 Use the four-way controller (▼) to select [Sound Effect].

9 Use the four-way controller (◀▶) to select [(On)/ (Off)].

10 Press the OK button.

[Start] appears on the LCD monitor and playback starts at the set interval.

OK button : Pauses the slideshow. Press again to restart the slideshow.

A button other than OK button: Stops the slideshow.



- The slideshow will continue until you press any button.
- Movies and pictures with a voice memo will be played through to the end before the next picture is played back, regardless of the set playback interval.
- Recordings made in Voice Recording mode are not played back.

Deleting Images, Movies and Sounds

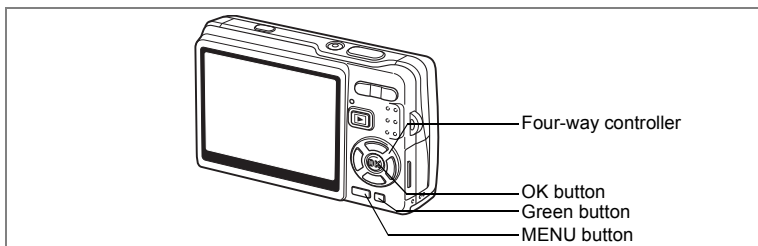

Deleting a Single Image, Movie or Sound

You can delete a single image, movie or sound.



Once deleted, images, movies or sounds cannot be restored.

- 1 Enter the Playback mode and use the four-way controller (◀▶) to select the image, movie or sound to delete.**
- 2 Press the Green /  button.**
The Delete screen appears.
- 3 Use the four-way controller (▲) to select [Delete].**
- 4 Press the OK button.**
The image, movie or sound is deleted.



- You can also delete images during the Instant Review. (p.36)
- You cannot delete protected images, movies or sounds. (p.142)

Deleting a Voice Memo only

If an image has a voice memo, you can delete the voice memo without deleting the image.

1 Enter the Playback mode and use the four-way controller (◀▶) to select an image with a voice memo to delete.

2 Press the Green button.

The Delete screen appears.

3 Use the four-way controller (▲) to select [Delete sound].

4 Press the OK button.

The voice memo is deleted.



Select Delete in Step 3 above to delete both the image and the voice memo.

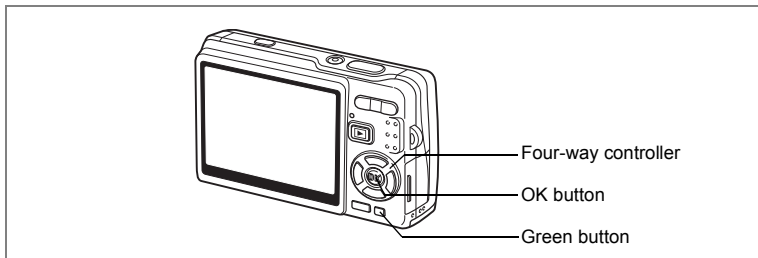

Deleting All Images, Movies or Sound Files

You can delete all the images, movies and sounds at once.



Once deleted, images, movies or sounds cannot be restored.

- 1 Enter the Playback mode and press the Green button twice.**
The Delete All screen appears.
- 2 Use the four-way controller (▲) to select [Delete All].**
- 3 Press the OK button.**

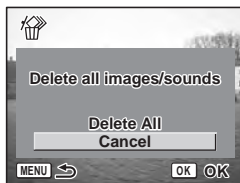

All the images and sounds will be deleted.



You cannot delete protected images, movies or sounds. (p.142)

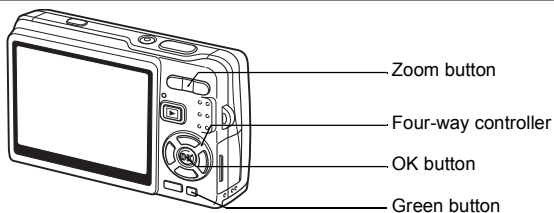

Deleting Selected Images and Sound Files (from Nine-Image Display)

You can delete several images/sound files selected from the nine-image display at once.

- 1 Enter the Playback mode and press $\blacktriangle\blacktriangledown\blacktriangleleft\blacktriangleright$ on the zoom button.**

Nine thumbnail images appear.

- 2 Press the Green button.**

[□] appears on the images and sound files.



- 3 Use the four-way controller ($\blacktriangle\blacktriangledown\blacktriangleleft\blacktriangleright$) to move the frame to an image or sound file you want to delete, and press the OK button.**

[✓] appears on the selected images and sound files.

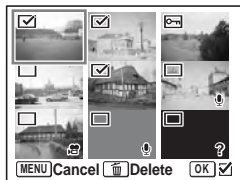

To check the image before deleting, place the frame on the image and press \blacktriangle / Q on the zoom button to show it in single-image display. (You cannot show a protected image in single-image display.)

Press the OK button to return to the nine-image display.

4 Press the Green button.

A confirmation dialog appears.

5 Use the four-way controller (▲▼) to select [Select & Delete].

6 Press the OK button.

The selected images and sound files are deleted.



You cannot delete protected images, movies or sounds. (p.142)

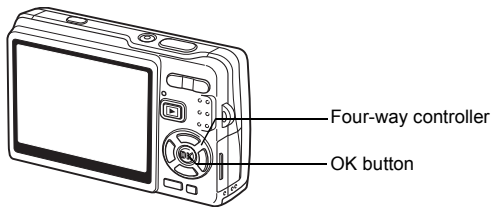

Protecting Images, Movies and Sounds from Deletion (Protect)

You can protect images, movies and sounds from being accidentally deleted.

- 1 Enter the Playback mode and use the four-way controller (◀▶) to select the image, movie or sound to protect.**
- 2 Press the four-way controller (▼).**
The Mode Palette appears.
- 3 Use the four-way controller (▲▼◀▶) to select  (Protect).**
- 4 Press the OK button.**
The Protect screen appears.

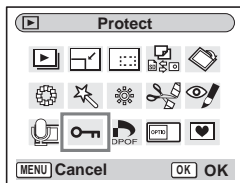

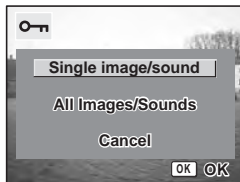

Protecting Images, Movies and Sounds

- 5 Use the four-way controller (▲▼) to select [Single image/sound].**
- 6 Press the OK button.**

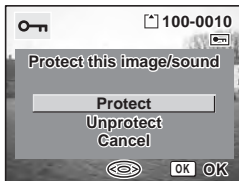

- 7 Use the four-way controller (▲▼) to select [Protect].
- 8 Press the OK button.



- Select Unprotect in Step 7 to cancel the Protect setting.
- If the image, movie or sound is protected, the  icon appears when it is played back.

Protecting All Images, Movies and Sounds

You can protect all the images, movies and sounds.

- 5 Use the four-way controller (▲▼) to select [All Images/Sounds].
- 6 Press the OK button.
The [Protect all images/sounds] message appears.
- 7 Use the four-way controller (▲▼) to select [Protect].
- 8 Press the OK button.

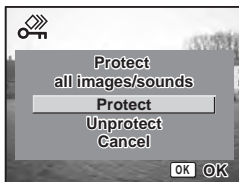
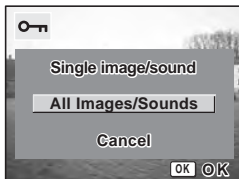

Select Unprotect in Step 7 to cancel the Protect setting on all the images, movies and sounds.



Even protected images, movies and sounds will be deleted by formatting the SD Memory Card or built-in memory.

Viewing Images on AV Equipment

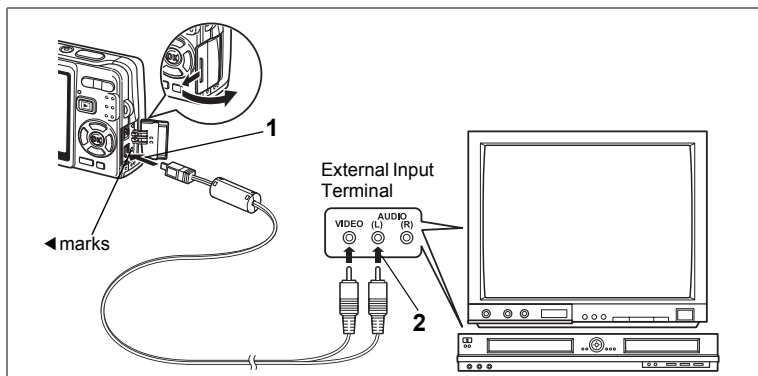

By using the AV cable, you can capture, play back and dub images on a TV or other equipment with a video IN jack. Make sure that both the AV equipment and the camera are turned off before connecting the cable.

1 Open the terminal cover and connect the supplied AV cable to the AV terminal.

Connect the AV cable to the AV terminal by aligning the arrow mark on the cable with the corresponding ◀ mark on the PC/AV connector of the camera.

2 Connect the other end of the AV cable to the AV equipment.

Yellow (video) → video input terminal

White (audio) → sound input terminal

When using stereo sound equipment, insert the sound jack into the L (white) terminal.

3 Turn the AV equipment on.

When the AV equipment connected to the camera and the AV equipment used to view images are separate, turn both pieces of equipment on.

To view images on a TV with several video inputs, switch the video inputs to the one connected to the camera, referring to the operating manual for the TV.

4 Turn the camera on.

Changing the Video Output Format  p.185



- If you intend to use the camera for a long time, use of the AC adapter kit K-AC63 (optional) is recommended. Refer to the operating manual for the TV or equipment to which the camera is connected.
- Images may not be displayed properly depending on the countries or areas when the Video Out setting is the default. In this situation, change the Video Out setting.
- While the camera is connected to the TV, the LCD monitor of the camera is turned off.

Playing Back an Image Using the Remote Control Unit (optional)

When the AV cable is connected to the camera, the image can be displayed using the remote control unit E or F (optional).

- 1 Press the  Playback button.**
- 2 Press the shutter release button or the zoom button on the remote control unit.**

Shutter release button : Displays the next image.

Zoom button : Displays the previous image.



- As there is no zoom button on the remote control unit F, only the shutter release button (displaying the next image) is available.
- You cannot play back movies, images with a voice memo, and sound files recorded in Voice Recording mode, using the remote control unit.

Setting the Printing Service (DPOF)

You can print the images on the SD Memory Card using a DPOF (Digital Print Order Format) compatible printer or at a printing service.

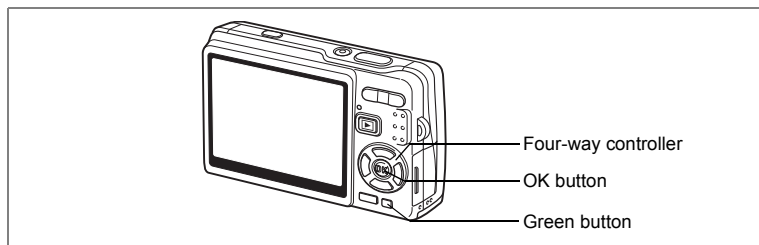

Printing Single Images

Set the following items for each image.

[Copies]: Select the number of copies up to a maximum of 99.

[Date] : Specify whether you want the date imprinted on the print or not.

- 1 Enter the Playback mode and use the four-way controller (◀▶) to select the image to print.**
- 2 Press the four-way controller (▼).**
The Mode Palette appears.
- 3 Use the four-way controller (▲▼◀▶) to select  (DPOF).**
- 4 Press the OK button.**
The DPOF screen appears.
- 5 Press the OK button.**

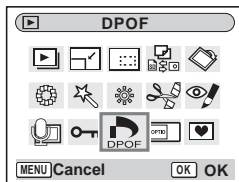

- 6 Use the four-way controller (▲▼) to select the number of copies.**



- 7 Use the Green button to select [(On)]/ (Off)] for [Date].**

- (On): The date will be imprinted.
- (Off): The date will not be imprinted.

- 8 Press the OK button.**

Prints can be made according to the settings.



- If DPOF settings have already been made for an image, the previous number of copies and date setting will be displayed.
- To cancel DPOF settings, set the number of copies to 0 and press the OK button.



- You cannot set the printing service for movies or sound-only files.
- Depending on the printer or printing equipment at the photo processing lab., the date may not be imprinted on the pictures even if the DPOF settings were made.

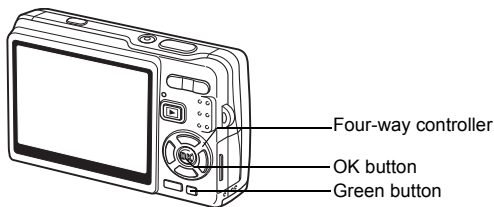

Printing All Images

- 1** Enter the Playback mode and press the four-way controller (▼).
The Mode Palette appears.
- 2** Use the four-way controller (▲▼◀▶) to select  (DPOF).
- 3** Press the OK button.
- 4** Use the four-way controller (▼) to select [All Images].
- 5** Press the OK button.
- 6** Use the four-way controller (▲▼) to select the number of copies.
You can print up to 99 copies.
- 7** Use the Green button to select whether to insert the date or not.
 (On): The date will be imprinted.
 (Off): The date will not be imprinted.
- 8** Press the OK button.



Prints can be made according to the settings.



The number of copies specified in this setting applies to all the images. Before printing, check that the number is correct.



- Settings for single images are canceled when settings are made for all images.
- DPOF settings are not possible for movies or sound-only files.

Direct Printing Using PictBridge

By connecting the camera to a printer that supports PictBridge using the USB cable (I-USB7) supplied with the camera, you can print images directly from the camera without using a PC. Select the images you want to print and the number of copies on the camera after it has been connected to the printer.



- We recommend the use of the AC adapter kit K-AC63 (optional) while the camera is connected to the printer. The printer may not work properly or the image data may be damaged if the battery runs out of power while the camera is connected to the printer.
- The access lamp blinks slowly while data is being transferred from the camera to the printer.
- Do not disconnect the USB cable during data transfer.
- Depending on the type of printer, not all the settings made on the camera (such as DPOF settings) may be valid.
- [USB Connection] is set to [PC] by default. Do not connect the camera to a printer when [PC] is selected.

Connecting the Camera to the Printer

- 1 Select [PictBridge] for [USB Connection] on the [X] Set-up] menu.**

Changing the USB Connection Mode p.185

- 2 Connect the camera to the printer using the USB cable supplied with the camera.**

The PictBridge menu appears.

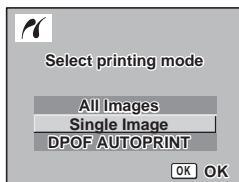

Printing Single Images

1 Use the four-way controller (▲▼) to select [Single Image].

2 Press the OK button.

The Print this image screen appears.

3 Use the four-way controller (◀▶) to select the image to print.

4 Use the four-way controller (▲▼) to select the number of copies.

You can print up to 99 copies.

5 Use the Green button to select whether to insert the date or not.

(On): The date will be imprinted.

(Off): The date will not be imprinted.

6 Press the OK button.

The print settings confirmation screen appears.

To print the image according to the print settings on the printer, press the OK button.

To change the print settings, go to Step 7.

7 Press the Green button.

The Change setting screen appears.

8 Select [Paper Size] and press the four-way controller (▶).

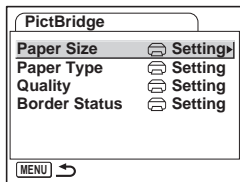
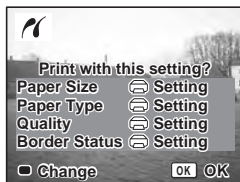
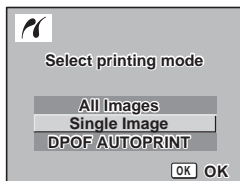

9 Use the four-way controller (▲▼◀▶) to select the paper size.

You can select only the paper sizes available with the printer you are using.

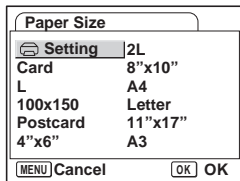

10 Press the OK button.

11 Repeat Step 8 to 10 to set [Paper Type] [Quality] and [Border Status].

When the Paper Size is set to [Printer Icon Setting], images are printed according to the printer settings.

Paper Type with more ★'s supports higher quality paper. Quality with more ★'s indicates higher print quality.

12 Press the OK button twice.

The image is printed according to the settings. Press the MENU button to cancel printing.

Printing All Images

1 Use the four-way controller (▲▼) to select [All Images].

2 Press the OK button.

The Print All screen appears.

Use the four-way controller (◀▶) to check the images and make sure you want to print them all.

3 Confirm the number of copies, the setting of the date, and the print setting, and then start printing.

To set these items and print the images, refer to Steps 4 to 11 on "Printing Single Images" (pages 150 to 151).



Printing Using the DPOF Settings

1 Use the four-way controller (▲▼) to select [DPOF AUTOPRINT].

2 Press the OK button.

The DPOF setting screen appears.

Use the four-way controller (◀▶) to check the images and the print settings.

3 Confirm the number of copies, the setting of the date, and the print setting, and then start printing.

To set the number of copies and the date imprint, refer to “Setting the Printing Service (DPOF)” (p.146). To print the images, refer to Steps 4 to 11 on “Printing Single Images” (pages 150 to 151).



Disconnecting the Camera from the Printer

Disconnect the camera from the printer when you have finished printing.

1 Turn the camera off.

2 Disconnect the USB cable from the camera.

3 Disconnect the USB cable from the printer.



If you disconnect the USB cable from the camera before you turn the camera off, the camera returns to Playback mode.

Editing Images

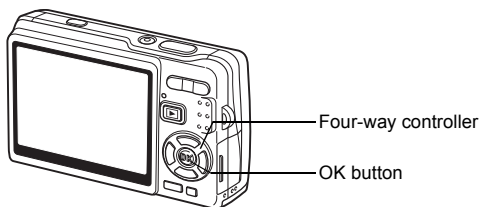

Changing the Image Size and Quality

By changing the size and quality of a selected image, you can make the file smaller than the original. You can use this function to continue taking pictures when the card or memory is full, by making the images smaller and overwriting the original images to make more space available in the memory.

Resizing Single Images

After changing the size and quality, the image can be saved as a new image or written over the original image.

- 1 Use the four-way controller (◀▶) in Playback mode to select an image to resize.**
- 2 Press the four-way controller (▼).**
The Mode Palette appears.
- 3 Use the four-way controller (▲▼◀▶) to select  (Resize).**
- 4 Press the OK button.**
The Resize screen appears.

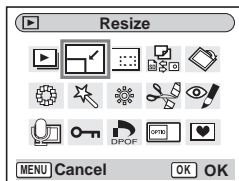

5 Use the four-way controller (◀▶) to change the size.

6 Press the four-way controller (▼).
The frame moves to [Quality Level].

7 Use the four-way controller (◀▶) to change the quality.

8 Press the OK button.

9 Use the four-way controller (▲▼) to select [Overwrite] or [Save as].

10 Press the OK button.

The resized image is saved.



- Movies cannot be resized.
- You cannot select a larger size than that of the original image.
- You can resize the data to 11M, 9M, 8M, 6M, 4M or 2M.
- Protected images cannot be overwritten.
- You can resize only still pictures taken with this camera.

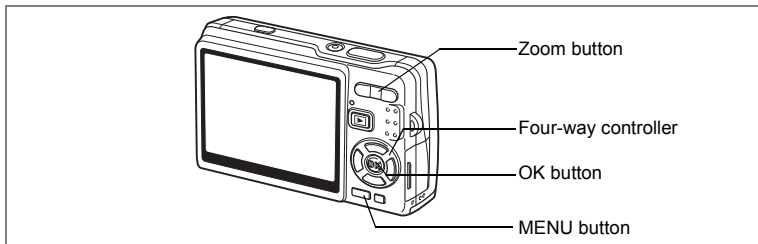

Cropping Images

You can crop a part of a picture and save it as a separate image.

1 Use the four-way controller (◀▶) in Playback mode to select an image to crop.

2 Press the four-way controller (▼).

The Mode Palette appears.

3 Use the four-way controller (▲▼◀▶) to select  (Cropping).

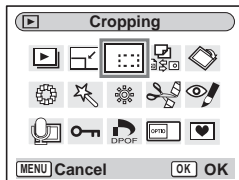

4 Press the OK button.

The Cropping screen appears.

5 Crop the image.

Zoom button (▲) : Enlarges the cropping frame.

Zoom button (▼) : Reduces the cropping frame.

Four-way controller: Moves the cropping frame.

MENU button : Returns to the Mode Palette.

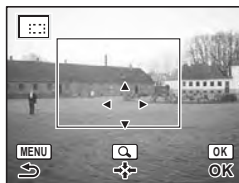

6 Press the OK button.

The cropped image is saved as a separate image.



- Movies cannot be cropped.
- The image size is changed and saved.
- You can only crop still pictures taken with this camera.

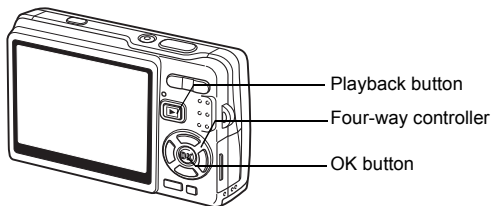

Rotating the Displayed Image

You can rotate a displayed image on the LCD monitor.

1 In Playback mode, use the four-way controller (◀▶) to select the image to be rotated.

2 Press the four-way controller (▼) in Playback mode.

The Mode Palette appears.

3 Use the four-way controller (▲▼◀▶) to select  (Image Rotation).

4 Press the OK button.

The Image Rotation screen appears.

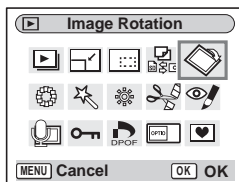

5 Press the four-way controller (▶) or the four-way controller (◀).

Four-way controller (▶): Rotates the image 90 degrees clockwise each time you press the button.

Four-way controller (◀): Rotates the image 90 degrees counter clockwise each time you press the button.



6 Press the  button.

The camera saves the rotated image and returns to Playback mode.



- You can rotate protected (Ⓞ) images, but the rotated image will not be saved.
- You cannot rotate movies.

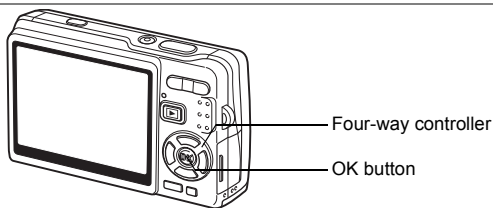

Editing Pictures with Color Filters

This function enables you to edit still pictures with color filters. You can select from thirteen filters: [B&W], [Sepia], [Eight colors], [B&W + Red], [B&W + Green], and [B&W + Blue].

- 1 Use the four-way controller (◀▶) in Playback mode to select an image to edit.**
- 2 Press the four-way controller (▼).**
The Mode Palette appears.
- 3 Use the four-way controller (▲▼◀▶) to select  (Color Filter).**
- 4 Press the OK button.**
The color filter screen appears.
- 5 Use the four-way controller (▲▼) to select a desired filter.**
- 6 Press the OK button.**
The overwrite confirmation screen appears.
- 7 Use the four-way controller (▲▼) to select [Overwrite] or [Save as].**
- 8 Press the OK button.**
The edited image is saved with the same number of recorded pixels and quality level as the original.

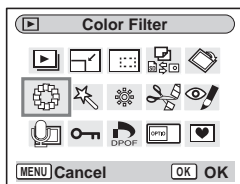

Selecting the Color Filter (Eight Colors)

- 5 Use the four-way controller (▲▼) to select  (Eight colors).**

The color bar appears.

- 6 Use the four-way controller (◀▶) to select a desired color.**

- 7 Press the OK button.**

The Overwrite confirmation screen appears.

- 8 Use the four-way controller (▲▼) to select [Overwrite] or [Save as].**

- 9 Press the OK button.**

The edited image is saved with the same number of recorded pixels and quality level as the original.



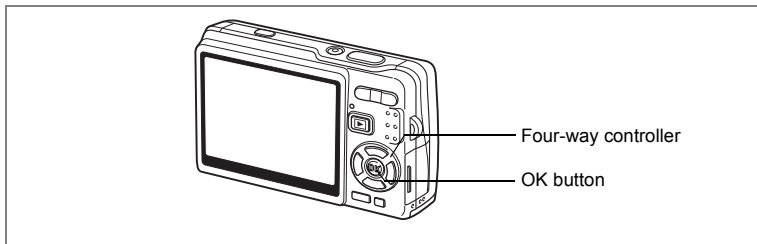

Editing Pictures with the Digital Filter

This function enables you to apply special effects to still pictures with the digital filter. You can select from five filters: [Soft], [Illustration], [Special Effect 1], [Special Effect 2] and [Slim].

- 1 Use the four-way controller (◀▶) in Playback mode to select an image to edit.**
- 2 Press the four-way controller (▼).**
The Mode Palette appears.
- 3 Use the four-way controller (▲▼◀▶) to select  (Digital Filter).**
- 4 Press the OK button.**
The Digital Filter screen appears.
- 5 Press the four-way controller (▲▼) to select a desired filter.**
- 6 Press the OK button.**
The overwrite confirmation screen appears.

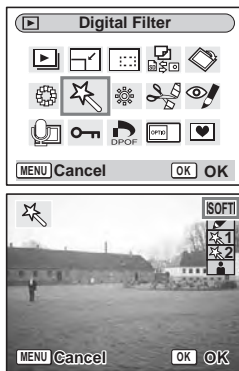

7 Use the four-way controller (▲▼) to select [Overwrite] or [Save as].

8 Press the OK button.

The edited image is saved with the same number of recorded pixels and quality level as the original.

Selecting the Slim Filter

5 Press the four-way controller (▲▼) to select  (Slim Filter).

6 Press the four-way controller (◀▶) to adjust the strength of the slim effect.

7 Press the OK button.

The overwrite confirmation screen appears.

8 Use the four-way controller (▲▼) to select [Overwrite] or [Save as].

9 Press the OK button.

The edited image is saved with the same number of recorded pixels and quality level as the original.

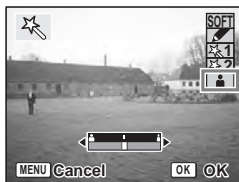

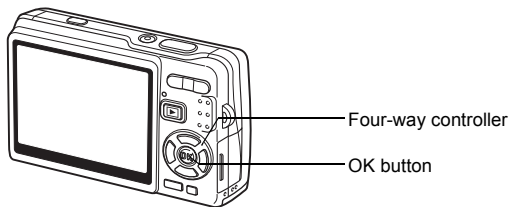

Editing Pictures with Brightness Filter

This function enables you to adjust the brightness of still pictures with the brightness filter.

1 Use the four-way controller (◀▶) in Playback mode to select an image to edit.

2 Press the four-way controller (▼).

The Mode Palette appears.

3 Use the four-way controller (▲▼◀▶) to select * (Brightness Filter).

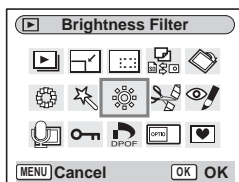

4 Press the OK button.

The brightness filter screen appears.

5 Use the four-way controller (◀▶) to adjust the brightness.

Four-way controller (▶): Brightens the image.

Four-way controller (◀): Darkens the image.

The brightness is selected between -2.0EV and +2.0EV by 1/3EV step.



6 Press the OK button.

The overwrite confirmation screen appears.

7 Use the four-way controller (▲▼) to select [Overwrite] or [Save as].

8 Press the OK button.

The edited image is saved with the same number of recorded pixels and quality level as the original.

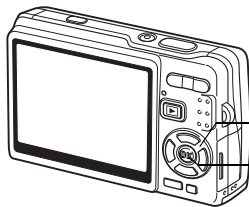

Four-way controller

OK button

Editing Movies

You can select a frame from a recorded movie to save as a still picture or divide a movie into two.

1 Use the four-way controller (◀▶) in Playback mode to select a movie to edit.

2 Press the four-way controller (▼).

The Mode Palette appears.

3 Use the four-way controller (▲▼◀▶) to select  (Movie Edit).

4 Press the OK button.

The Movie Edit screen appears. Select the editing function that you want to use.

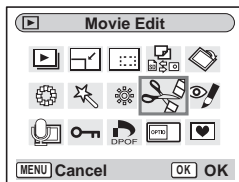

Saving a Frame from a Movie as a Still Picture

5 Use the four-way controller (▲▼) to select [Save as Still Image].

6 Press the OK button.

The screen for choosing a frame appears.

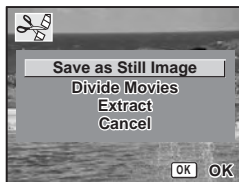

- 7 Press the four-way controller (▲) to play back a movie. Press (▲) again to pause the movie at the point you want to save.**

The following operations are available during pause.

Four-way controller (◀): Reverses the movie frame by frame.

Four-way controller (▶): Advances the movie frame by frame.



- 8 Press the OK button.**

The selected frame is saved as a still picture.

Dividing a Movie

- 5 Select [Divide Movies] on the Movie Edit screen.**

- 6 Press the OK button.**

The screen for choosing the dividing position appears.

- 7 Press the four-way controller (▲) to play back a movie. Press (▲) again to pause the movie at the desired dividing position.**

The following operations are available during pause.

Four-way controller (◀): Reverses the movie frame by frame.

Four-way controller (▶): Advances the movie frame by frame.



- 8 Press the OK button.**

The confirmation screen appears.

- 9 Use the four-way controller (▲▼) to select [Divide].**

- 10 Press the OK button.**

The movie is divided at the specified position and the two portions are saved as separate files.

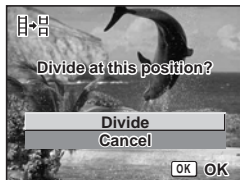

Extracting Movies

5 Select [Extract] on the Movie Edit screen.

6 Press the OK button.

The Extract screen appears.

7 Press the four-way controller (▲) to play back the movie and press it again to select the desired start point.

The movie is paused.

The following operations are available during pause.

Four-way controller (▶): Advances the movie frame by frame.

Four-way controller (◀): Reverses the movie frame by frame.

8 Press the OK button.

9 Press the four-way controller (▲) to play back the movie and press it again to select the desired end point.

The movie is paused.

The following operations are available during pause.

Four-way controller (▶): Advances the movie frame by frame.

Four-way controller (◀): Reverses the movie frame by frame.

10 Press the OK button.

The extracted movie is saved.

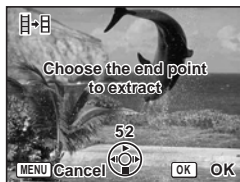
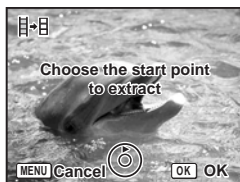

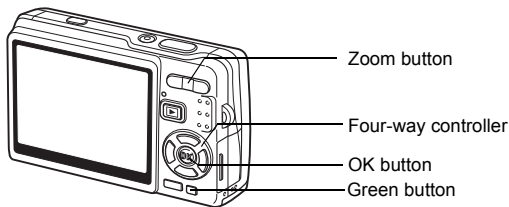

Removing Red-eye

You can remove red-eye (a phenomenon that occurs when the flash reflects from the subject's eyes) from your pictures.

1 In Playback mode, press the four-way controller (◀▶) to select the image you want to correct.

2 Press the four-way controller (▼).

The Mode Palette appears.

3 Use the four-way controller (▲▼◀▶) to select  (Red-eye Compensation).

4 Press the OK button.

A confirmation dialog for overwriting the image appears.

If the error message [Cannot process correctly] appears, go to the step 5 in "Removing Red-eye Manually" (page 167).

5 Use the four-way controller (▲▼) to select [Overwrite] or [Save as].

When the image is protected, [Save as] will be selected automatically.

6 Press the OK button.

The edited image is saved with the same number of recorded pixels and quality level as the original.

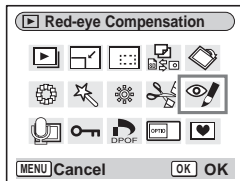

- Red-eye compensation function cannot be used for movies. If you try to do so, the error message will appear as described in step 4.
- Red-eye compensation function can only be used for still pictures taken with this camera.

Removing Red-eye Manually

If the camera does not detect the red-eye, remove it manually.

5 Press the OK button.

The message [Select the area to compensate] and the screen for specifying the area for compensation appears.

6 Specify the area for compensation.

Four-way controller: Moves the area.

(▲▼◀▶)

Zoom button (▲) : Enlarges the area.

Zoom button (▼) : Reduces the area.



7 Press the Green button.

Compensation starts.

When no error message appears, the compensation was successfully done. Go to the step 8.

If the error message [Cannot process correctly] appears, repeat the steps 5, 6 and 7.

8 Press the OK button.

A confirmation dialog for overwriting the image appears.

9 Use the four-way controller (▲▼) to select [Overwrite] or [Save as].

When the image is protected, [Save as] will be selected automatically.

10 Press the OK button.

The corrected image is saved with the same number of recorded pixels and quality level as the original.

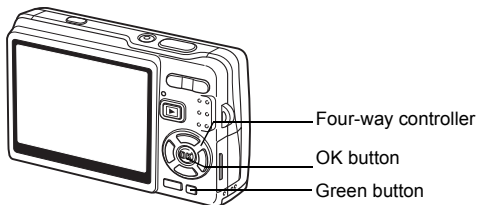

Adding a Frame (Frame Composite)

This function lets you add a decorative frame to still pictures. There are three frames already stored in the camera.

1 Use the four-way controller (◀▶) in Playback mode to select the image to which you want to add a frame.

2 Press the four-way controller (▼).

The Mode Palette appears.

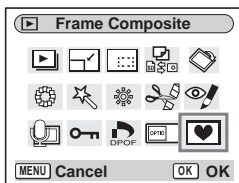

3 Use the four-way controller (▲▼◀▶) to select ♥ (Frame Composite).

4 Press the OK button.

The frame selection screen appears.

5 Use the four-way controller (◀▶) to select a frame.



6 Press the OK button.

A confirmation dialog for overwriting the image appears.

7 Use the four-way controller (▲▼) to select [Overwrite] or [Save as].

[Save as] is the only option available for protected images.



8 Press the OK button.

The edited image is saved with the recorded pixels of 3M.



The frame composite function cannot be used on movies or images with any size of 3M or smaller. An error message appears in Step 4.

To Register a New Frame

To switch to the screen for registering a frame, press the Green button in Step 5. You can register frames which you have downloaded from the internet, etc. When you register a new frame, it replaces one of the existing frames in the built-in memory. Before you can register a new frame, copy it first to the SD Memory Card.



When a new frame on the SD Memory Card is registered in the built-in memory, it replaces one of the existing frames in the built-in memory. The replaced frame is deleted from the built-in memory.

1 In the frame selection screen, select the frame you want to remove and press the Green button.

A message appears and the frames on the SD Memory Card that you can register in the built-in memory appear.

2 Use the four-way controller (◀▶) to select the frame you want to register and press the OK button.

The frame is registered in the built-in memory and replaces the frame selected in Step 1.

Visit the PENTAX website at the URL below to download new frames.

http://www.pentax.co.jp/english/support/digital/frame_02.html

Copying Files

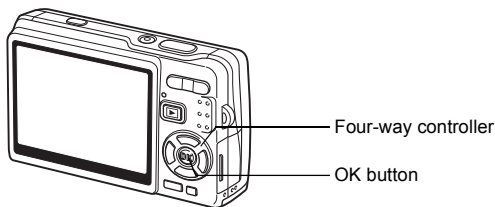

You can copy image and sound files from the built-in memory to the SD Memory Card and vice versa. This function can only be selected when a card has been inserted in the camera.

When files are copied from the built-in memory to the SD Memory Card, all the files are copied at once. When files are copied from the SD Memory Card to the built-in memory, the files are copied one at a time.

1 Press the four-way controller (▼) in Playback mode.

The Mode Palette appears.

2 Use the four-way controller (▲▼◀▶) to select (Image/Sound Copy).

3 Press the OK button.

The Image/Sound Copy screen appears.

Select the copying method you want to use.

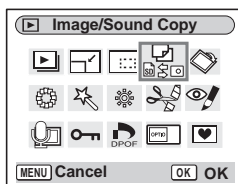

Be sure to turn the camera off before inserting or removing the SD Memory Card.

To Copy Files from the Built-in Memory to the SD Memory Card

- 4 Use the four-way controller (▲▼) to select [📁 → SD] and press the OK button.

All the files are copied to the SD Memory Card.

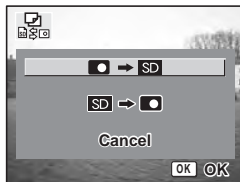

To Copy Files from the SD Memory Card to the Built-in Memory

- 4 Use the four-way controller (▲▼) to select [SD → 📁] and press the OK button.
- 5 Use the four-way controller (◀▶) to select the file to copy.
- 6 Press the OK button.

The selected file is copied to the built-in memory.



- If the image has a voice memo, the sound file will be copied at the same time as the image.
- When a file is copied from the SD Memory Card to the built-in memory, it is assigned a new file name.

Camera Settings

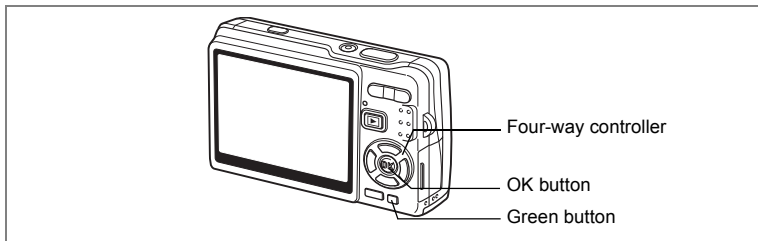

Setting Up the Start-up Screen

You can display an image recorded with the camera as the start-up screen when the camera is turned on.

1 Press the four-way controller (▼) in Playback mode.

The Mode Palette appears.

2 Press the four-way controller (▲▼◀▶) to select (Start-up Screen).

3 Press the OK button.

The screen for setting start-up screen appears. You can select from five different types of start-up screens, including [USER] and [Off].

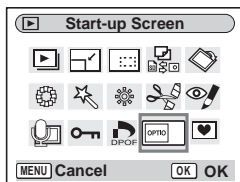

Setting Up the Start-up Screen Using a Captured Image (Go to Step 5 to select a start-up screen other than USER)

- 4 Press the Green button, while displaying [USER] in the upper-right corner of the screen, and use the four-way controller (◀▶) to select an image for the start-up screen, and press the OK button.**

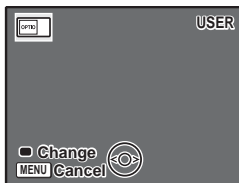

To change a captured image set as a start-up screen to another image, press the Green button once to delete the image and press it again to show the screen for selecting a captured image.

- 5 Press the OK button.**

The camera is ready for playing back images.



- Once the start-up screen has been set, it will not be deleted even if the original image is deleted or the SD Memory Card or built-in memory is formatted.
- You cannot set up the start-up screen while playing back images on a TV or other equipment.

How to recall the [X↓ Set-up] menu

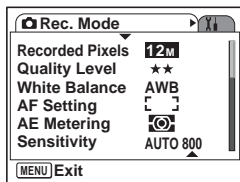
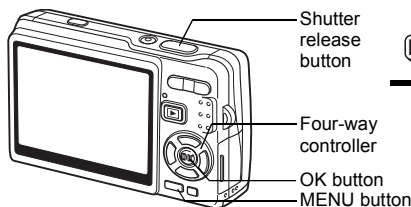

Formatting an SD Memory Card or the Built-in Memory

Formatting will delete all the files on the SD Memory Card if you are using a card, and all the files in the built-in memory if there is no SD Memory Card inserted.



- Do not remove the SD Memory Card while the card is being formatted as this may damage the card and render it unusable.
- SD Memory Cards formatted on a PC or device other than the camera cannot be used. Be sure to format the card with the camera.
- Note that formatting will also delete protected files.

7

Settings

1 Select [Format] on the [X↓ Set-up] menu.

2 Press the four-way controller (▶).

The Format screen appears.

3 Use the four-way controller (▲) to select [Format].

4 Press the OK button.

Formatting starts. When formatting is completed, the camera is ready for taking pictures.

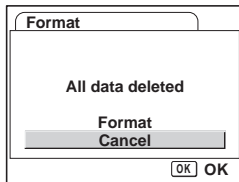

If formatting was performed in Playback mode, the camera returns to Playback mode after it was completed, then the [No image/sound] message appears.

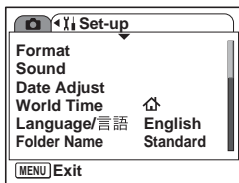

Changing the Sound Settings

You can adjust the playback volume and the volume of operation sounds, such as the start-up sound, shutter sound and operation sound. You can also change the operation sounds.

- 1 Select [Sound] on the [X Set-up] menu.**
- 2 Press the four-way controller (▶).**

The screen for setting sounds appears.
[Operation Volume] is highlighted.

Changing the Volume

- 3 Use the four-way controller (◀▶) to change the operation volume.**
- 4 Use the four-way controller (▼) to select [Playback Volume].**
- 5 Use the four-way controller (◀▶) to change the volume of playback sounds.**
- 6 Press the shutter release button halfway.**

The camera is ready for taking pictures.

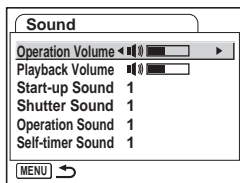

How to recall the [X] Set-up] menu

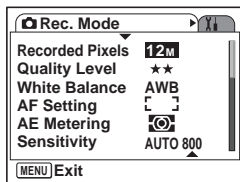
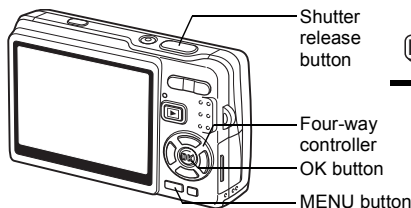

Changing the Sound

- Use the four-way controller (▲▼) to select [Start-up Sound].
- Press the four-way controller (▶).
The pull-down menu appears.
- Use the four-way controller (▲▼) to select [1], [2], [3] or [Off].
- Press the OK button.
- Change [Shutter Sound], [Operation Sound] and [Self-timer Sound] in the same manner.
- Press the shutter release button halfway.
The camera is ready for taking pictures.

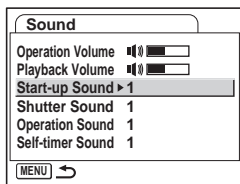

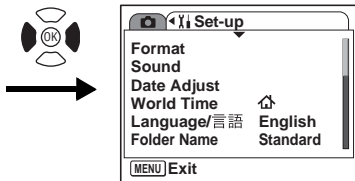

Changing the Sound (Using a Recorded Sound File)

You can use the sound recorded on the camera for sound settings. The first two seconds of the selected sound file will be played as [USER] sound.

1 Select [USER] in Step 5 in “Changing the Sound”.

2 Press the OK button.

The playback screen for the recorded sound files appears.

3 Use the four-way controller (◀▶) to select a sound file.

Play back the selected file to confirm.

Four-way controller (▲): Plays back the first two seconds of the sound file.

Four-way controller (▼): Stops playback.

4 Press the OK button.

The selected sound is set as the [USER] sound.

5 Set [Shutter sound], [Operation Sound] and [Self-timer Sound] in the same manner.

6 Press the shutter release button halfway.

The camera is ready for taking pictures.



The Sound settings are saved when the camera is turned off.

How to recall the [X↓ Set-up] menu

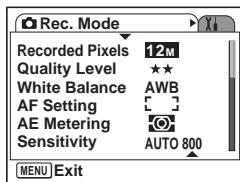
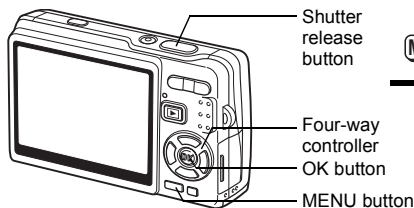

Changing the Date and Time

You can change the initial date and time settings. You can also set the style in which the date appears on the camera. Select [mm/dd/yy], [dd/mm/yy] or [yy/mm/dd].

1 Select [Date Adjust] on the [X↓ Set-up] menu.

2 Press the four-way controller (▶).

The Date Adjust screen appears.

3 Press the four-way controller (▶).

The frame moves to [mm/dd/yy].

4 Use the four-way controller (▲▼) to select the date display style.

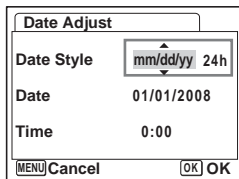

5 Press the four-way controller (▶).

The frame moves to [24h].

6 Use the four-way controller (▲▼) to select [24h] (24-hour display) or [12h] (12-hour display).

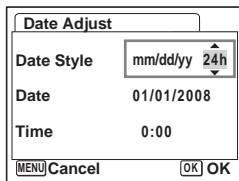

7 Press the four-way controller (▶).

The frame moves to [Date Style].

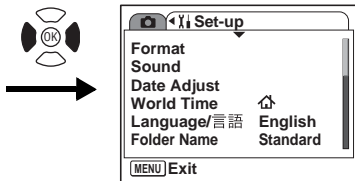

8 Press the four-way controller (▼).

The frame moves to [Date].

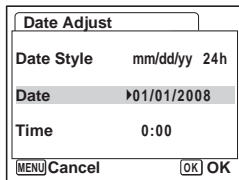

9 Press the four-way controller (▶).

The frame moves to month.

10 Use the four-way controller (▲▼) to change the month.

Change the day and year in the same manner.

Next, change the time.

If you select [12h] in Step 6, the setting switches between “am” and “pm” corresponding to the time.

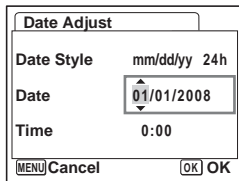

11 Press the OK button.

The settings are made.

12 Press the shutter release button halfway.

The camera is ready for taking pictures.

How to recall the [X↓ Set-up] menu

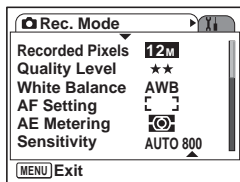
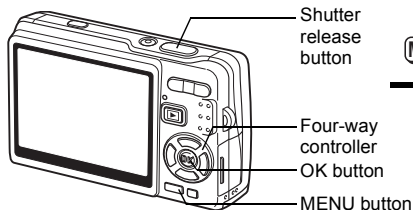

Setting the World Time

The date and time selected in “Initial Settings (Setting the Display Language and the Date and Time)” (p.29) serve as the Home Time setting. You can display the time in a city other than the Home Time city (World Time). This is useful when taking pictures abroad.

1 Select [World Time] on the [X↓ Set-up] menu.

2 Press the four-way controller (▶).

The World Time screen appears.

3 Use the four-way controller (◀▶) to select [↗ (Destination)] or [↖ (Hometown)].

↗ (Destination): Displays the time in the city selected as the Destination city.

↖ (Hometown): Displays the time in the city selected as the Hometown city.

4 Press the four-way controller (▼) to select [↗ (Destination)].

5 Press the four-way controller (▶).
The Destination screen appears. The city that is currently selected blinks on the map.

6 Use the four-way controller (◀▶) to change the Destination city.

The location of the destination and the time difference between the hometown and the destination appear.



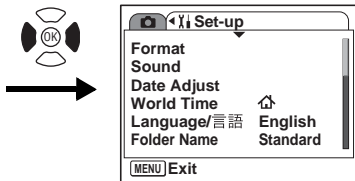

- 7 Use the four-way controller (▼) to select [DST].**
- 8 Use the four-way controller (◀▶) to select [(On) / (Off)].**
Select [(On)] if the Destination city uses daylight saving time.
- 9 Press the OK button.**
The World Time setting is saved.
- 10 Press the four-way controller (▼) to select [(Hometown)].**
Set the location and the current time in the same manner as Steps 5 to 9.
- 11 Press the shutter release button halfway.**
The camera is ready for taking pictures.

How to recall the [X] Set-up menu

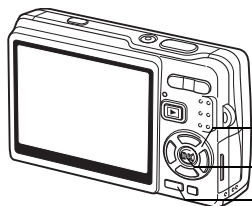

Four-way controller
OK button
MENU button

MENU

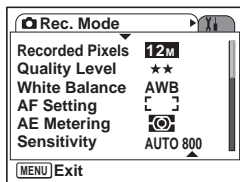

Changing the Display Language

You can change the language in which the menus, error messages, etc. are displayed.

You can select from [English], [French], [German], [Spanish], [Portuguese], [Italian], [Dutch], [Danish], [Swedish], [Finnish], [Polish], [Czech], [Hungarian], [Turkish], [Russian], [Thai], [Korean], [Chinese (traditional and simplified)] and [Japanese].

- 1** Select [Language/言語] on the [X] Set-up menu.
- 2** Press the four-way controller (▶).
- 3** Use the four-way controller (▲ ▼ ◀ ▶) to select the language.
- 4** Press the OK button.
- 5** Press the MENU button.

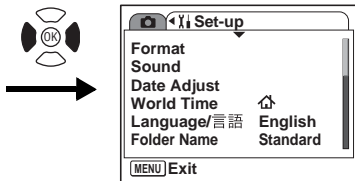

Changing the Image Folder Name

You can select the folder name style from [Standard] or [Date]. When you select [Date], pictures and sound files are saved in separate folders of the shooting/recording date.

Folder Name

Standard	xxxPENTX (xxx is 3-digit folder number.)
Date	xxx_mmdd (3-digit folder number_month day)

Example:

When [Standard] selected (Shooting date: January 26) When you change to [Date] (Shooting date: January 26) When you take pictures next time (Shooting date: January 30)

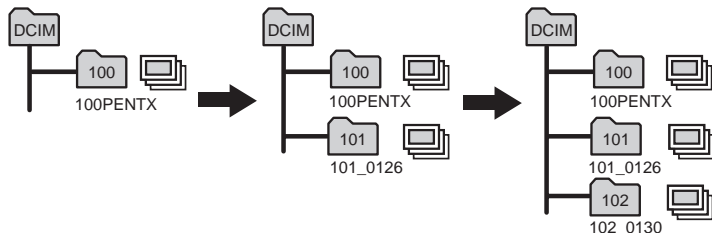

- 1 Select [Folder Name] on the [X↓ Set-up] menu.
 - 2 Press the four-way controller (▶).
- The pull-down menu appears.
- 3 Use the four-way controller (▲▼) to select [Standard] or [Date].
 - 4 Press the OK button.



- If you set [Date Style] to [dd/mm/yy], the folder name appears as “xxx_ddmm” (3-digit folder number_day month).
- The capacity of an image folder is 500 files maximum. When the number of files reaches 500, a new folder will be automatically created.

How to recall the [X] Set-up] menu

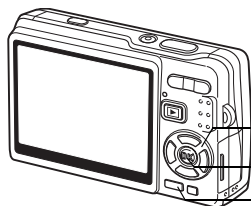

Four-way controller
OK button
MENU button

MENU

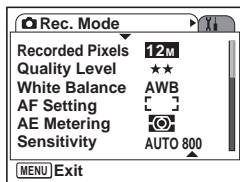

Changing the USB Connection Mode

You can change the USB Connection mode depending on whether the USB cable is to be connected to a printer (PictBridge) or a computer.

- 1 Select [USB Connection] on the [X] Set-up] menu.**
- 2 Press the four-way controller (▶).**
- 3 Use the four-way controller (▲▼) to select [PC] or [PictBridge].**
- 4 Press the [▶] Playback button.**

The camera is ready for playing back images.

7

Settings



For details on connecting the camera to a computer, see "PC Connection Manual" (a separate volume).



- Do not connect the camera to a computer when [Pictbridge] is selected.
- Do not connect the camera to a printer when [PC] is selected.

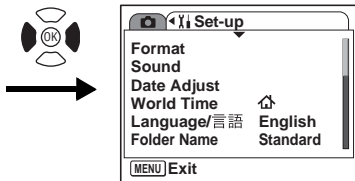

Changing the Video Output Format

You can select the output format (NTSC or PAL) for taking or playing back images on a TV.

- 1 Select [Video Out] on the [\llcorner Set-up] menu.**
- 2 Press the four-way controller (▶).**

The pull-down menu appears.
- 3 Use the four-way controller (▲▼) to select [NTSC] or [PAL].**

Select the video output format to match the output format of the TV.
- 4 Press the ▶ Playback button.**

The camera is ready for playing back images.

How to recall the [X] Set-up] menu

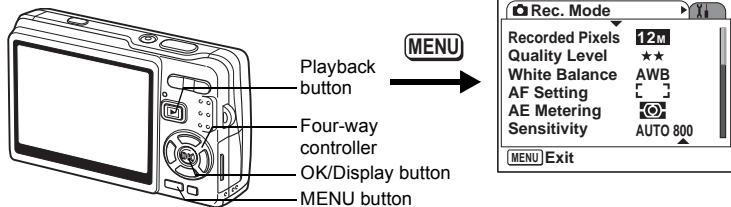

Adjusting the Brightness of the LCD Monitor

You can adjust the brightness of the LCD monitor by seven levels.

- 1 Select [Brightness Level] on the [X] Set-up] menu.**
- 2 Use the four-way controller (◀▶) to adjust the brightness.**

Slide leftwards : Darkens the LCD monitor.

Slide rightwards : Brightens the LCD monitor.

- 3 Press the [▶] Playback button.**

The camera is ready for playing back images.

7

Settings



When you press and hold the OK/Display button for more than 1 second, the LCD monitor turns brighter for a certain amount of time. (LCD Bright Mode) It is useful when you view the LCD monitor outdoors or in brighter places. (p.36, p.37)

The function is not available under the following conditions.

- When the menu or the Mode Palette is displayed.
- In Voice Recording mode

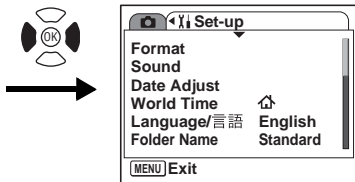

Setting Power Saving

By setting the LCD monitor to dim automatically when you leave the camera without performing any operations for a certain period, you can lessen battery drain. When Power Saving takes effect and the LCD monitor dims, press any button to return to the ordinary brightness.

- 1 Select [Power Saving] on the [X↓ Set-up] menu.**
- 2 Press the four-way controller (▶).**
- 3 Use the four-way controller (▲▼) to select [2 min], [1 min], [30 sec], [15 sec], [5 sec] or [Off].**
- 4 Press the ▶ Playback button.**

The camera is ready for playing back images.



The Power Saving function will not work in the following conditions.

- In Playback mode
- When the USB cable is connected.
- While taking movies
- During the video output
- When using the AC adapter
- While using the LCD booster function

How to recall the [X↓ Set-up] menu

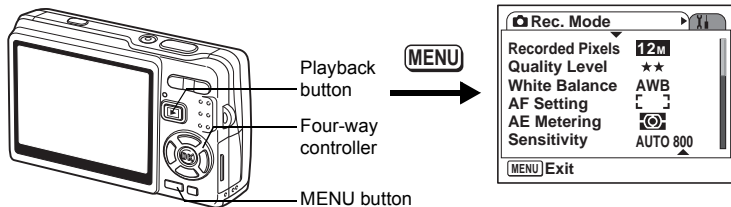

Setting Auto Power Off

You can set the camera to turn off automatically when no operation is performed after a fixed time.

- 1 Select [Auto Power Off] on the [X↓ Set-up] menu.**
- 2 Press the four-way controller (▶).**
The pull-down menu appears.
- 3 Use the four-way controller (▲▼) to select [5 min], [3 min] or [Off].**
- 4 Press the [▶] Playback button.**

The camera is ready for playing back images.

7

Settings



The Auto Power Off function does not work in the following conditions.

- When the USB cable is connected
- While taking movies
- While playing back movies
- While recording voices
- While playing back voices
- While executing the slide show
- While using the LCD booster function

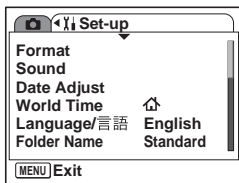

Setting the Guide Display

You can show the information on the current mode and the functions currently assigned to the Green button when you start up the camera in Capture mode or switch from other modes to Capture mode. You can also show the description for the selected mode on the Mode Palette.

- 1 Select [Guide Display] on the [X↓ Set-up] menu.**
- 2 Use the four-way controller (◀▶) to select [(On)/ (Off)].**
- 3 Press the  Playback button.**

The camera is ready for playing back images.

Resetting to Default Settings

You can return all the settings other than the date and time, world time, Language/言語, and video out to the default settings.

- 1 Select [Reset] on the [X↓ Set-up] menu.**
- 2 Press the four-way controller (▶).**
The Reset screen appears.
- 3 Use the four-way controller (▲) to select [Reset].**
- 4 Press the OK button.**

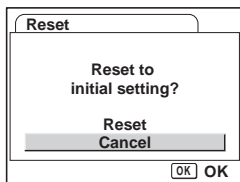

The settings return to the defaults and the camera is ready for taking or playing back images.

List of Cities

This is a list of cities which you can select for the World Time.

Region	City	Region	City
North America	Honolulu	Africa/West Asia	Nairobi
	Anchorage		Jeddah
	Vancouver		Tehran
	San Francisco		Dubai
	Los Angeles		Karachi
	Calgary		Kabul
	Denver		Male
	Chicago		Delhi
	Miami		Colombo
	Toronto		Kathmandu
	New York		Dacca
	Halifax		
Central and South America	Mexico City	East Asia	Yangon
	Lima		Bangkok
	Santiago		Kuala Lumpur
	Caracas		Vientiane
	Buenos Aires		Singapore
	Sao Paulo		Phnom Penh
	Rio de Janeiro		Ho chi Minh
Europe	Lisbon		Jakarta
	Madrid		Hong Kong
	London		Beijing
	Paris		Shanghai
	Amsterdam		Manila
	Milan		Taipei
	Rome		Seoul
	Copenhagen		Tokyo
	Berlin	Guam	
	Prague	Oceania	Perth
	Stockholm		Adelaide
	Budapest		Sydney
	Warsaw		Noumea
	Athens		Wellington
	Helsinki		Auckland
	Moscow		Pago Pago
Africa/West Asia	Dakar		
	Algiers		
	Johannesburg		
	Istanbul		
	Cairo		
	Jerusalem		

Default Settings

The table below lists the factory default settings.

Last Memory Setting

Yes : The current setting (last memory) is saved when the camera is turned off.

No : The setting returns to the default setting when the camera is turned off.

* : The setting depends on the Memory setting (p.122).

Reset Setting

Yes : The setting returns to the default setting with the Reset function (p.189).

No : The setting is saved even after reset.

● [Rec. Mode] Menu Items

Item	Default Setting	Last Memory Setting	Reset Setting	Page	
Recorded Pixels	12M	Yes	Yes	p.95	
Quality Level	★★ (Better)	Yes	Yes	p.97	
White Balance	AWB (Auto)	*	Yes	p.98	
AF Setting	Focusing Area	[] (Multiple)	Yes	Yes	p.100
	Focus Limiter	On	Yes	Yes	p.101
	Aux. AF Light	On	Yes	Yes	p.102
AE Metering	 (Multi-segment)	*	Yes	p.103	
Sensitivity	AUTO800	*	Yes	p.104	
EV Compensation	±0.0	*	Yes	p.106	
Movie	Recorded Pixels	640 (640×480)	Yes	Yes	p.107
	Quality Level	★★★ (Best)	Yes	Yes	p.108
	Movie SR	On	Yes	Yes	p.109
Shake Reduction	On	Yes	Yes	p.110	
Digital Zoom	On	*	Yes	p.89	
Instant Review	0.5 sec	Yes	Yes	p.111	
Face Priority	On	Yes	Yes	p.112	
D-Range Comp.	Off	Yes	Yes	p.113	
One push PF	On	Yes	Yes	p.114	









Item		Default Setting	Last Memory Setting	Reset Setting	Page
Memory	Flash Mode	On	-	Yes	p.93
	Drive Mode	Off	-	Yes	p.83 to p.87
	Focus Mode	Off	-	Yes	p.90
	Zoom Position	Off	-	Yes	p.88
	MF Position	Off	-	Yes	p.91
	White Balance	Off	-	Yes	p.98
	AE Metering	Off	-	Yes	p.103
	Sensitivity	Off	-	Yes	p.104
	EV Compensation	Off	-	Yes	p.106
	Digital Zoom	On	-	Yes	p.89
	DISPLAY	Off	-	Yes	p.53
File #	On	-	Yes	-	
Green Button		Green Mode	Yes	Yes	p.115
Sharpness		Standard	Yes	Yes	p.118
Saturation		Standard	Yes	Yes	p.119
Contrast		Standard	Yes	Yes	p.120
Date Imprint		Off	Yes	Yes	p.121

● [X] Set-up] Menu

Item		Default Setting	Last Memory Setting	Reset Setting	Page
Format		-	-	-	p.174
Sound	Operation Volume	3	Yes	Yes	p.175
	Playback Volume	3	Yes	Yes	
	Start-up Sound	1	Yes	Yes	
	Shutter Sound	1	Yes	Yes	
	Operation Sound	1	Yes	Yes	
Self-timer Sound		1	Yes	Yes	
Date Adjust	Date Style	According to initial setting	Yes	No	p.178
World Time	Select time	Hometown	Yes	No	p.180
	Destination (City)	Same as Hometown	Yes	No	
	Destination (DST)	Same as Hometown	Yes	No	
	Hometown (City)	According to initial setting	Yes	No	
	Hometown (DST)	According to initial setting	Yes	No	

Item	Default Setting	Last Memory Setting	Reset Setting	Page
Language/言語	According to initial setting	Yes	No	p.29
Folder Name	Standard	Yes	Yes	p.183
USB Connection	PC	Yes	Yes	p.184
Video Out	According to initial setting	Yes	No	p.185
Brightness Level	4	Yes	Yes	p.186
Power Saving	5 sec	Yes	Yes	p.187
Quick Zoom	Off	Yes	Yes	p.130
Auto Power Off	3 min	Yes	Yes	p.188
Guide Display	On	Yes	Yes	p.189

● Playback Mode Palette Items

Item		Default Setting	Last Memory Setting	Reset Setting	Page
	Slideshow	Interval	3 sec	Yes	p.135
		Screen Effect	Wipe	Yes	
		Sound Effect	On	Yes	
	Resize	According to the taken picture	No	-	p.153
	Cropping	-	No	-	p.155
	Image/Sound Copy	Cancel	No	-	p.170
	Image Rotation	Normal	No	No	p.156
	Color Filter	B&W	No	-	p.157
	Digital Filter	SOFT	No	-	p.159
	Brightness Filter	0	No	-	p.161
	Movie Edit	Save as Still Image	No	-	p.163
	Red-eye Compensation	-	-	-	p.166
	Voice Memo	-	-	-	p.127
	Protect	Single image/sound	Yes	No	p.142
	DPOF	Single Image	Yes	No	p.146
	Start-up Screen	Optio Logo screen	Yes	No	p.172
	Frame Composite	-	Yes	Yes	p.168

● Available functions for each Capture mode

○: Available ×: Not available

		AUTO PICT	P	Tv	M							
Flash Mode	Auto	○	○	×	×	○	○	○	○	○	○	○
	Flash Off	○	○	○	○	○	○	○	○	○	○	○
	Flash On	○	○	○	○	○	○	○	○	○	○	○
	Auto + Red-eye	○	○	×	×	○	○	○	○	○	○	○
	Flash On + Red-eye	○	○	○	○	○	○	○	○	○	○	○
	Soft Flash	○	○	○	○	○	○	○	○	○	○	○
Drive Mode	Self-timer	○	○	○	○	○	○	○	○	○	○	○
	Continuous Shooting	○	○	○	○	○	○	○	○	○	○	○
	Multi-exposure	*18	*18	*18	*18	*18	*18	*18	*18	*18	*19	*18
	Remote Control	○	○	○	○	○	○	○	○	○	○	○
Focus Mode	Standard (Autofocus)	○	○	○	○	○	○	○	○	○	○	○
	Macro	○	○	○	○	○	○	○	○	○	○	○
	Super Macro	○	○	○	○	○	○	○	○	○	○	○
	Pan Focus	○	○	○	○	○	○	○	○	○	○	○
	Infinity	○	○	○	○	○	○	○	○	○	○	○
	Manual Focus	○	○	○	○	○	○	○	○	○	○	○
Rec. Mode menu	Recorded Pixels	○	○	○	○	○	○	○	○	○	*9	○
	Quality Level	○	○	○	○	○	○	○	○	○	○	○
	White Balance	*1	○	○	○	○	*1	*1	*1	*1	*1	*1
	Focusing Area	○	○	○	○	○	○	○	○	○	○	*15
	Focus Limiter	○	○	○	○	○	○	*7	○	○	○	○
	Aux. AF Light	○	○	○	○	○	*7	○	○	○	○	*17
	AE Metering	*2	○	*4	*4	○	*2	*2	*2	*2	*2	*2
	Sensitivity	○	○	*5	*6	○	○	○	○	○	○	○
	EV Compensation	×	○	○	×	○	○	○	○	○	○	○
	Face Priority	*0	○	○	○	○	○	○	*0	*0	*0	*0
	D-Range Comp.	○	○	○	○	○	○	○	○	○	○	○
	Sharpness	*3	○	○	○	○	*3	*3	*3	*3	*3	*3
	Saturation	*3	○	○	○	○	*3	*3	*3	*3	*3	*3
	Contrast	*3	○	○	○	○	*3	*3	*3	*3	*3	*3
Date Imprint	○	○	○	○	○	○	○	○	○	○	○	
Others	Digital Zoom	○	○	○	○	○	○	○	○	○	○	○
	Intelligent Zoom	○	○	○	○	○	○	○	○	○	○	○
	LCD Backlight Off	○	○	○	○	○	○	○	○	○	○	○

*0: Fixed to On.

*1: Fixed to AWB.

*2: Fixed to Multi-segment.

*3: Fixed to Standard.

*4: Multi-segment cannot be selected.

*5: Fixed to AUTO800.

*6: AUTO cannot be selected.

*7: Set to Off. (changeable)

*8: Set to Flash Off. (changeable)

*9: Fixed to 5M for (Digital SR).

Fixed to 3M for (Half-length Portrait) and (Frame Composite).

○	○	○	○	○	○	○	×	-	Auto	Flash Mode
○	○	*8	*8	○	○	○	○	-	Flash Off	
○	○	○	○	○	○	○	×	-	Flash On	
○	○	○	○	○	○	○	×	-	Auto + Red-eye	
○	○	○	○	○	○	○	×	-	Flash On + Red-eye	
○	○	○	○	○	○	○	×	-	Soft Flash	
○	○	○	○	○	○	○	○	-	Self-timer	Drive Mode
○	○	○	○	○	○	×	×	-	Continuous Shooting	
*18	*18	*18	*18	*18	*18	×	×	-	Multi-exposure	
○	○	○	○	○	○	○	×	-	Remote Control	
○	○	○	○	○	○	○	○	-	Standard (Autofocus)	Focus Mode
○	○	○	○	○	○	○	○	-	Macro	
○	○	○	○	○	○	○	○	-	Super Macro	
○	○	○	○	○	○	○	○	-	Pan Focus	
○	○	○	○	○	○	○	○	-	Infinity	
○	○	○	○	○	○	○	○	-	Manual Focus	
○	*9	○	○	○	○	*9	○	-	Recorded Pixels	Rec. Mode menu
○	○	○	○	○	○	○	○	-	Quality Level	
*1	○	*1	*1	*1	*1	○	○	-	White Balance	
○	○	*15	*15	○	○	*10	*11	-	Focusing Area	
○	○	○	*7	*7	*7	○	*12	-	Focus Limiter	
○	○	*17	*17	○	○	○	*12	-	Aux. AF Light	
*2	○	*2	*2	*2	*2	○	*13	-	AE Metering	
○	○	○	○	○	○	○	*16	-	Sensitivity	
○	○	○	○	○	○	○	○	-	EV Compensation	
○	○	○	○	○	○	○	○	-	Face Priority	
○	○	○	○	○	○	○	×	-	D-Range Comp.	
*3	○	*3	*3	*3	*3	○	○	-	Sharpness	
*3	○	*3	*3	*3	*3	○	○	-	Saturation	
*3	○	*3	*3	*3	*3	○	○	-	Contrast	
○	○	○	○	○	○	○	×	-	Date Imprint	
○	○	○	○	○	○	○	*14	-	Digital Zoom	
○	×	○	○	○	○	○	×	-	Intelligent Zoom	
○	○	○	○	○	○	○	×	○	LCD Backlight Off	

*10: Automatic tracking AF cannot be selected.

*11: Fixed to Spot.

*12: Fixed to Off.

*13: Fixed to Center-weighted.

*14: Available only when Movie SR is set to Off.

*15: Set to Automatic tracking AF. (changeable)

*16: Fixed to AUTO.

*17: Available unless Automatic tracking AF is selected.

*18: Fixed to 5M.

*19: Fixed to 3M.

Optional Accessories

A number of dedicated accessories are available for this camera. Products with an asterisk (*) are the same as those supplied with the camera.

● Power related accessories

Rechargeable lithium-ion battery D-LI8 (*)

Battery charger kit K-BC8 (*)

(Set includes battery charger D-BC8 and AC plug cord.)

AC adapter kit K-AC63

(Set includes AC-adapter D-AC63 and AC plug cord.)

● Connection cables

USB cable I-USB7 (*)

AV cable I-AVC7 (*)

● Strap

Chain strap O-ST8

Strap O-ST20 (*)

Leather strap O-ST24 (genuine leather)

Sports strap O-ST30 (water resistant)

● Case

Camera case O-CC73

● Remote Control

Remote control unit E (zoom function)

Remote control unit F

Messages

Messages such as the following may appear on the LCD monitor during camera operation.

Message	Description
Shake Reduction is OFF	The Shake Reduction preview button is pressed when [Shake Reduction] is set to Off on the [ Rec.Mode] menu. Set it to On. (p.110)
Compression error	Compression of the image you captured has failed. Change the quality/size and try again.
No image/sound	There are no images/sounds on the SD Memory Card or in the built-in memory.
Memory card full	The SD Memory Card or the built-in memory is full and no more images can be saved.
Built-in memory full	Insert a new SD Memory Card or delete unwanted images. (p.23, 137) Change the quality/size and try again. (p.153)
Image/sound cannot be created	You can only record up to 10,000 files due to the specifications of the camera, even when using a large volume SD Memory Card. Delete unwanted files to continue recording.
Memory card error	Shooting and playback are impossible due to a problem with the SD Memory Card. You may be able to play back the images or sounds on a PC.
Card not formatted	The SD Memory Card you have inserted is unformatted or has been formatted on a PC or other device and is not compatible with this camera. (p.174)
Card locked	The SD Memory Card is write-protected. Only menu operation and mode change are possible.
Data being recorded	This is displayed when you switch to Playback mode while the image is being saved or protect setting or DPOF settings are being saved. The message disappears when saving of an image or setting is completed.
Data being processed	The image is being recorded on the SD Memory Card or in the built-in memory.
	The protect setting or DPOF settings are being changed.
	The movie is being recorded.
	The image is being processed with digital filter.
	The movie is being edited.
	The SD Memory Card or built-in memory is being formatted.
Deleting	The image or sound is being deleted.













Message	Description
Camera cannot play this image and sound	You are trying to play back an image or sound in a format not supported by this camera. You may be able to play it back on another brand of camera or PC.
Battery depleted	The battery is exhausted. Recharge the battery or replace with a charged battery. (p.16)
Image folder cannot be created	The largest folder number has been used and the largest file number has been assigned to an image and no more images can be saved. Insert a new SD Memory Card or format the SD Memory Card or built-in memory. (p. 23, 174)
Protected	The image or sound you are trying to delete is protected.
This image/sound cannot be processed	You are trying to resize, crop, protect an image, or you are trying to set an image for DPOF, or you are trying to edit an image with a digital filter or edit a movie while the image or movie cannot be processed with these functions.
No image to be processed	There is no file that can be processed with the Playback Mode Palette.

Messages such as the following may appear on the LCD monitor when using the PictBridge function.

Message	Description
No paper in the printer	There is no paper in the printer.
No ink in the printer	There is no ink in the printer.
Printer error	An error message has been sent from the printer.
Data error	A data error message has been sent from the printer.
Paper stuck in the printer	The paper in the printer has jammed.

Troubleshooting

Problem	Cause	Remedy
The camera will not turn on	The battery is not installed	Check if a battery is installed. If not, install a battery. (p.16)
	The battery is installed incorrectly	Check orientation of the battery and reinsert it. (p.16)
	The battery is exhausted	Charge the battery. (p.17)
	The battery performance has temporarily deteriorated because it is too cold	Warm up the battery by putting it in a pocket where it can come in contact with body heat.
No image appears on the LCD monitor	The LCD monitor is set to Off	Press the OK/Display button to turn the LCD monitor On.
	The image is displayed but is hard to see	The image on the LCD monitor may be hard to see when taking pictures outside in sunlight. Try raising the brightness of the LCD monitor.
The shutter will not release	The flash is charging	When the flash icon blinks red on the LCD monitor, the flash is charging and no pictures can be taken. The flash icon lights red when charging is completed.
	There is no available space on the SD Memory Card or in the built-in memory.	Insert an SD Memory Card with available space or delete unwanted images. (p.23, 137)
	Recording	Wait until recording is finished.
	The number of image, movie, and sound files recorded on the SD Memory Card has reached 10,000.	Replace the SD card with another having available space or delete unwanted files.
The picture is dark	The subject is too far away in a dark environment, such as a night scene	The picture will become dark if the subject is too far away. Take pictures within the specified flash range.
	The background is dark	When taking a picture of a person against a dark background, such as a night scene, the background may appear dark if the flash does not reach it, even with the correct exposure. Set the capture mode to  (Night Scene) to ensure that both the person and the background are clear. (p.53, 77)

Problem	Cause	Remedy
The subject is not in focus	The subject is difficult to focus on	The camera may have difficulty in focusing on such subjects as: low-contrast subjects (a white wall, a blue sky, etc.), dark subjects, finely-patterned objects, rapidly-moving objects. It is also difficult to get proper focus when shooting through a window or a net. Try shooting using the focus lock (p.33) or Manual Focus (p.91).
	The subject is not in the focusing area	Locate the desired subject in the focus frame [] (focusing area) in the center of the LCD monitor. If it is difficult to do so, first lock the focus on the desired subject (focus lock), and then move the camera to recompose. (p.33)
	The subject is too close	Set the focus mode to  (Macro) or  (Super Macro). (p.90)
	The focus mode is set to  (Macro) or  (Super Macro)	Normal pictures will be out of focus if taken with the focus mode set to  (Macro) or  (Super Macro).
The flash does not discharge	The flash mode is set to Off	Set the flash mode to Auto or  . (p.93)
	The Capture mode is set to  (Movie) mode, Continuous Shooting, Infinity,  (Sport) mode, or  (Pet) mode	The flash will not discharge in these modes. You can cancel the non-flash setting in  (Sport) mode and  (Pet) mode.
The USB Connection with a personal computer does not function properly.	The USB Connection setting of the camera is set to PictBridge.	Set the USB Connection setting to PC. (p.184)
The USB Connection with a printer does not function properly.	The USB Connection setting of the camera is set to PC.	Set the USB Connection setting to PictBridge. (p.184)

Very occasionally, static electricity may cause camera malfunction. In this case, remove the battery and install it again. If the camera is then working properly, normal condition is restored and you can continue using the camera.

Main Specifications

Camera

Type	Fully automatic compact digital still camera with built-in zoom lens	
Effective Pixels	12.0 megapixels	
Sensor	12.40 megapixels (total pixels), 1/1.7-inch interline transfer CCD with a primary color filter	
Recorded Pixels	Still Picture	12M (4000×3000), 10M (3648×2736), 7M (3072×2304), 5M (2592×1944), 3M (2048×1536), 1024 (1024×768), 640 (640×480) * Fixed to 5M (2592×1944) for Digital SR mode and Multi-exposure mode, and 3M (2048×1536) for Frame Composite mode and Half-length Portrait mode.
	Movie	640 (640×480), 320 (320×240)
Sensitivity	AUTO, Manual (50/100/200/400/800/1600 (/3200 Digital SR mode))	
File Format	Still Picture	JPEG (Exif2.2), DCF, DPOF, PRINT Image Matching III
	Movie	AVI (MPEG-4 DivX), approx. 30 fps with sound, Movie SR (25 fps image signals recorded at 30 fps)
	Sound	WAV (PCM system), monaural, max. recording time approx. 17 hours 11 min. 28 sec. (when using a 1GB SD Memory Card)
Quality Level	"Best", "Better", "Good"	
Storage Medium	Built-in memory (approx. 21 MB), SD Memory Card, SDHC Memory Card	

Image Storage Capacity and Recording Time (When using a 1GB SD Memory Card)

Still Pictures

Quality Level \ Recorded Pixels	Best ★★★	Better ★★	Good ★	Sound
12M	201	291	404	17 hr. 11 min. 28 sec.
10M	242	350	486	
7M	342	495	685	
5M	481	695	963	
3M	728	1053	1458	
1024	1856	2682	3714	
640	3405	4918	6811	

Movie

Quality Level \ Recorded Pixels	★★★ Best	★★ Better	★ Good
640 (640×480)	46 min. 0 sec.	57 min. 38 sec.	69 min. 11 sec.
320 (320×240)	177 min. 56 sec.	221 min. 3 sec.	254 min. 52 sec.

* The above table indicates the approximate number of images and recording time. The number of images and recording time may vary depending on an SD Memory Card and subject.

D-Range Compensation D-Range Compensation is available (Auto, Manual)		
White Balance	Auto, Daylight, Shade, Tungsten Light, Fluorescent Light, Manual	
Lens	Focal Length	7.9 mm - 23.7 mm (equivalent to 37 mm - 111 mm in 35 mm format)
	Maximum Aperture	f/2.8 - f/5.4
	Lens Composition	7 elements in 5 groups (two dual-sided aspherical elements, one single-sided aspherical element)
	Zoom Type	Electrically driven
	Picture Range	Approx. 64.9 mm × 48.6 mm (screen is filled) (Super Macro mode)
	Lens Cover	Electrically driven
Intelligent Zoom	3.3× at 10M (3648 × 2736), 3.9× at 7M (3072 × 2304), 4.6× at 5M (2592 × 1944), 5.7× at 3M (2048 × 1536), 11.4× at 1024 (1024 × 768), 17.9× at 640 (640 × 480), The ratio of 3× optical zoom included. The ratios are approximate.	
Digital Zoom	6× maximum, or equivalent to 17.9× maximum (3× optical zoom ratio included) in all recorded pixels.	
LCD Monitor	Wide viewing angle 2.5-inch TFT color LCD, approx. 232,000 pixels, with LCD backlight, low reflective type, the brightness of backlight adjustable in three steps (Power Saving, Normal, LCD Bright Mode).	
Playback Functions	Single-frame, 9 frame index, calendar, enlargement (max. 8×, scrollable), movie playback, sound playback, histogram display, Select & Delete Playback Mode Palette (Slideshow, Resize, Cropping, Image/Sound Copy, Image Rotation display, Color Filter, Digital Filter, Brightness Filter, Movie Edit, Red-eye Compensation, Voice Memo, Protect, DPOF, Start-up Screen, Frame Composite)	
	Color filter	B&W, Sepia, Color filter (Bar display, Eight colors), B&W + Red, B&W + Green and B&W + Blue.
	Digital filter	Soft, Illustration, Special Effect 1, Special Effect 2, Slim
	Brightness filter	Brightness filter
Focusing System	Type	TTL contrast detection system by sensor, auxiliary AF light, 5-point AF, Spot AF, or Automatic tracking AF selectable, Focus lock is possible by pressing the shutter release button halfway.
	Focus Range	Normal: Approx. 0.35 m - ∞ (full zoom range) Macro: Approx. 0.12 m - Approx. 0.4 m (at full wide-angle to 11.5 mm) Super Macro: Approx. 0.06 m - Approx. 0.15 m (full wide-angle) Infinity, Pan Focus, Manual Focus selectable
Exposure Mechanism	AE Metering	TTL metering by sensor (multi-segment, center-weighted, spot)
	Exposure Modes	Picture modes, Program, Shutter Priority, Manual Exposure
	EV Compensation	±2 EV (can be set in 1/3 EV steps)
Capture Modes	Green, Mode Palette (Auto Picture, Program (Tv, M selectable), Night Scene, Movie, Voice Recording, Landscape, Flower, Natural Skin Tone (Portrait, Half-length Portrait selectable), Kids, Digital SR, Sport (Surf & Snow selectable), Pet, Text, Food, Frame Composite)	

Movie	Shooting Time	Minimum approx. 1 sec., recordable until the capacity of SD Memory Card reaches full. (The continuous recording is possible until the file size reaches 2 GB.)
	Editing Functions	Save as Still Image, Divide Movies, Extract
Shutter	Type	Electronic/mechanical shutter
	Speed	Approx. 1/2000 sec. - 4 sec.
Flash	Type	Auto flash with red-eye reduction function
	Flash Modes	Auto, Flash Off, Flash On, Auto + Red-eye, Flash On + Red-eye, Soft Flash
	Effective Range	Wide: Approx. 0.06 m - Approx. 7.1 m (ISO sensitivity at AUTO 800) Tele: Approx. 0.35 m - Approx. 3.5 m (ISO sensitivity at AUTO 800)
Drive Modes	Single-frame, 10-sec. Self-timer, 2-sec. Self-timer, Multi-exposure, Multi-exposure (Self-timer/Remote), Continuous, 3-sec. Remote Control, Instant Remote Control	
Self-timer	Electronic control type, delay time: approx. 10 sec., 2 sec.	
Time Function	World Time setting for 75 cities (28 time zones)	
Power Supply	Rechargeable lithium-ion battery D-LI8, AC adapter (optional)	
Battery Life	Still Images	Approx. 180 (at 23°C with LCD monitor on, flash fired for 50% of shots and using a rechargeable lithium ion battery D-LI8) * The number of recordable images is based on the CIPA standard measurement, but it may vary with the conditions under which the camera is used.
	Playback time	Approx. 200 min. * Measured based on PENTAX standard and may vary depending on the condition of use.
	Maximum charging time	Approx. 100 min.
In/Out Port	PC/AV terminal (PC communication type USB 2.0, high-speed-compatible), external power supply terminal	
Video Output Format	NTSC, PAL	
Size	91 (W) × 56.5 (H) × 23.5 (D) mm (excluding operating members and projections)	
Weight	130 g (excluding battery and SD Memory Card)	
Weight When Shooting	150 g (including battery and SD Memory Card)	
Accessories	Rechargeable lithium-ion battery, battery charger, AC plug cord, USB cable, software (CD-ROM), AV cable, strap, operating manual	

WARRANTY POLICY

All PENTAX cameras purchased through authorized bona fide photographic distribution channels are guaranteed against defects of material or workmanship for a period of twelve months from date of purchase. Service will be rendered, and defective parts will be replaced without cost to you within that period, provided the equipment does not show evidence of impact, sand or liquid damage, mishandling, tampering, battery or chemical corrosion, operation contrary to operating instructions, or modification by an unauthorized repair shop. The manufacturer or its authorized representatives shall not be liable for any repair or alterations except those made with its written consent and shall not be liable for damages from delay or loss of use or from other indirect or consequential damages of any kind, whether caused by defective material or workmanship or otherwise; and it is expressly agreed that the liability of the manufacturer or its representatives under all guarantees or warranties, whether expressed or implied, is strictly limited to the replacement of parts as hereinbefore provided. No refunds will be made on repairs by non-authorized PENTAX service facilities.

Procedure During 12-month Warranty Period

Any PENTAX which proves defective during the 12-month warranty period should be returned to the dealer from whom you purchased the equipment or to the manufacturer. If there is no representative of the manufacturer in your country, send the equipment to the manufacturer, with postage prepaid. In this case, it will take a considerable length of time before the equipment can be returned to you owing to the complicated customs procedures required. If the equipment is covered by warranty, repairs will be made and parts replaced free of charge, and the equipment will be returned to you upon completion of servicing. If the equipment is not covered by warranty, regular charges of the manufacturer or of its representatives will apply. Shipping charges are to be borne by the owner. If your PENTAX was purchased outside of the country where you wish to have it serviced during the warranty period, regular handling and servicing fees may be charged by the manufacturer's representatives in that country. Notwithstanding this, your PENTAX returned to the manufacturer will be serviced free of charge according to this procedure and warranty policy. In any case, however, shipping charges and customs clearance fees to be borne by the sender. To prove the date of your purchase when required, please keep the receipt or bills covering the purchase of your equipment for at least a year. Before sending your equipment for servicing, please make sure that you are sending it to the manufacturer's authorized representatives or their approved repair shops, unless you are sending it directly to the manufacturer. Always obtain a quotation for the service charge, and only after you accept the quoted service charge, instruct the service station to proceed with the servicing.

- This warranty policy does not affect the customer's statutory rights.
- The local warranty policies available from PENTAX distributors in some countries can supersede this warranty policy. Therefore, we recommend that you review the warranty card supplied with your product at the time of purchase, or contact the PENTAX distributor in your country for more information and to receive a copy of the warranty policy.



The CE Mark is a Directive conformity mark of the European Union.

For customers in USA

STATEMENT OF FCC COMPLIANCE

This device complies with Part 15 of the FCC Rules. Operation is subject to the following two conditions: (1) This device may not cause harmful interference, and (2) this device must accept any interference received, including interference that may cause undesired operation.

Changes or modifications not approved by the party responsible for compliance could void the user's authority to operate the equipment.

This equipment has been tested and found to comply with the limits for a Class B digital device, pursuant to part 15 of the FCC Rules.

These limits are designed to provide reasonable protection against harmful interference in a residential installation. This equipment generates, uses and can radiate frequency energy and, if not installed and used in accordance with the instructions, may cause harmful interference to radio communications. However, there is no guarantee that interference will not occur in a particular installation.

If this equipment does cause harmful interference to radio or television reception, which can be determined by turning the equipment off and on, the user is encouraged to try to correct the interference by one or more of the following measures:

- Reorient or relocate the receiving antenna.
Increase the separation between the equipment and receiver.
Connect the equipment into an outlet on a circuit different from that to which the receiver is connected.
- * Consult the dealer or an experienced radio/TV technician for help.

For customers in Canada

This Class B digital apparatus complies with Canadian ICES-003.

Pour les utilisateurs au Canada

Cet appareil numérique de la classe B est conforme à la norme NMB-003 du Canada.

FOR CALIFORNIA, U.S.A. ONLY

Perchlorate Material-special handling may apply.

The lithium battery used in this camera contains perchlorate material, which may require special handling.

See www.dtsc.ca.gov/hazardouswaste/perchlorate

Declaration of Conformity
According to 47CFR, Parts 2 and 15 for
Class B Personal Computers and Peripherals

We: PENTAX IMAGING COMPANY
A Division of PENTAX of America, Inc.

Located at: 600 12th Street, Suite 300
Golden, Colorado 80401 U.S.A.
Phone: 303-799-8000 FAX: 303-790-1131

Declare under sole responsibility that the product identified herein, complies with 47CFR Parts 2 and 15 of the FCC rules as a Class B digital device. Each product marketed is identical to the representative unit tested and found to be compliant with the standards. Records maintained continue to reflect the equipment being produced can be expected to be within the variation accepted, due to quantity production and testing on the statistical basis as required by 47CFR §2.909. Operation is subject to the following two conditions: (1) This device may not cause harmful interference, and (2) This device must accept any interference received, including interference that may cause undesired operation. The above named party is responsible for ensuring that the equipment complies with the standards of 47CFR §15.101 to §15.109.

Product Name: PENTAX Digital Still Camera

Model Number: Optio A40

Contact person: Customer Service Manager

Date and Place: February, 2008, Colorado

Information on disposal for users



1. In the European Union

If your product is marked with this symbol, it means that used electrical/electronic products should not be mixed with general household waste. There exists a separate collection system for these products.

Used electric/electronic equipment must be treated separately and in accordance with legislation that requires proper treatment, recovery and recycling of these products. Following the implementation by member states, private households within the EU states may return their used electrical/electronic equipments to designated collection facilities free of charge*. In some countries your local retailer may also take back your old product free of charge if you purchase a similar new one.

* Please contact your local authority for further details.

By disposing of this product correctly you will help ensure that the waste undergoes the necessary treatment, recovery and recycling and thus prevent potential negative effects on the environment and human health which could otherwise arise due to inappropriate waste handling.

2. In other countries outside the EU

If you wish to discard this product, please contact your local authorities and ask for the correct method of disposal.

For Switzerland: Used electrical/electronic equipment can be returned free of charge to the dealer, even when you don't purchase a new product. Further collection facilities are listed on the home page of www.swico.ch or www.sens.ch.

Symbols

	[Rec.Mode] menu	45
	[Set-up] menu	45
	Playback button	41, 42, 44
	(Playback mode)	37
	(Tele)	88
	(Wide)	88
	(Zoom display/Zoom)	88, 129
	(Nine-image display)	133
	(Delete button)	38, 137
	(Green button)	41, 59
	(Green Mode)	59
	(Auto Picture mode)	61
	(Program mode)	63
	(Manual Exposure mode)	63
	(Shutter Priority mode)	63
	(Night Scene mode)	77
	(Movie mode)	79
	(Voice Recording mode)	124
	(Landscape mode)	67
	(Flower mode)	67
	(Natural Skin Tone mode)	69
	(Portrait mode)	69
	(Half-length Portrait)	69
	(Sport mode)	67
	(Surf & Snow mode)	67
	(Self-timer)	83
	(Continuous Shooting)	84
	(Pet mode)	75
	(Text mode)	76
	(Food mode)	67
	(Digital SR mode)	78
	(Frame Composite mode)	81
	(SD Memory Card)	23, 129
	(Built-in memory)	23, 129
	(Battery level indicator)	18
	(Movie SR On)	79, 109
	(Shake Reduction On)	53, 110

	(Shake Reduction Off)	110
--	-----------------------	-----

A

AC Adapter	21
AC plug cord	17
Access lamp	13
Auto Picture Mode	61
Auto Power Off	188
Autofocus mode	90
Autofocus Settings	100
Auxiliary AF light	102
AV cable	144

B

Battery	16
Battery Level Indicator	18
Battery/card cover	13, 16
Best	26
Better	26
Brightness Filter	161
Brightness Level	186

C

Calendar Display	133
Capture Mode	41
Capture Mode Palette	50
Color Filters	157
Color Saturation	119
Continuous Shooting	84
Copying image and sound files	170
Cropping	155

D

Date and Time	178
Delete All Images	139
Delete Images	137
Digital Filter	159
Digital SR	78
Display Language	182
DPOF	146

D-Range Comp. 113

E

Exposure 106

F

Face recognition 69

Flash 13

Flash Mode 93

Fn Setting 116

Focus frame 33

Focus Limiter 101

Focus lock 35

Focus Mode 90

Focusing Area 100

Folder Name 183

Format 174

Four-way controller 14, 41, 42

Frame Composite 81, 168

G

Good 26

Green button 14, 41, 43, 115

Green Mode 59

Guide Display 189

H

Half-length Portrait 69

Histogram 54, 56

Home Time 180

I

Image Contrast 120

Image quality of movies . . . 27, 108

Image quality of still pictures 26, 97

Image Sharpness 118

Image Size of movies 27, 107

Image Size of still pictures . . 26, 95

Infinity mode 90

Initial Settings 29

Instant Review 36, 111

Intelligent Zoom 88

K

Kids Mode 69

L

LCD Bright Mode . . . 36, 37, 41, 43, 186

Lens 13

Light Metering mode 103

M

Macro mode 90

Manual Exposure mode 63

Manual Focus mode 90

Memory 122

MENU button 14, 41, 43

Menu List 48

Messages 197

Microphone 14

Movie Edit 163

Movie SR 109

Multi-exposure 85

N

Natural Skin Tone mode 69

Night Scene Mode 77

Nine-Image Display 133

NTSC 32, 185

Number of recordable images . . . 18

O

OK/Display button . . . 14, 36, 41, 44

One push PF 114

Operating Time 18

Optional Accessories 196

P

PAL 32, 185

Pan Focus mode 90

Pet Mode 75

PictBridge 149

Picture Mode 67

Play back Movies 131

Play back Sound 126

Play back Still Pictures 37

Play back the Previous or Next

Image	37	Strap	15
Playback button	14, 41, 42	Super Macro mode	90
Playback Mode	42	Symbols	9
Playback Mode Palette	52	T	
Portrait Mode	69	Take Movies	79
Power indicator	13	Take Still Pictures	33
Power Saving	187	Tele	88
Power switch	13	Text	76
Printer	149	Tripod socket	13
Program Mode	63	TV	144
Protect	142	U	
Q		USB cable	149
Quick Zoom	130	USB Connection	184
R		V	
Rec. Mode Menu	48	Video Output Format	185
Recording Sound	124	Voice Memo	127
Red-eye Compensation	166	Voice Recording Mode	44, 124
Remote Control	86, 145	W	
Reset	189	White Balance	98
Resize images	153	Wide	88
Rotate images	156	World Time	180
S		Write-protect switch	25
SD Memory Card	23, 25	Z	
Self-timer	83	Zoom	88
Self-timer lamp	13	Zoom button	14, 41, 42
Sensitivity	104	Zoom Display	129
Set the Menus	45		
Set-up Menu	49		
Shake Reduction for Still Pictures	57, 110		
Shake Reduction preview button	13, 57		
Shutter Priority Mode	63		
Shutter release button	13, 33		
Shutter Sound	176		
Slideshow	135		
Sound Settings	175		
Speaker	13		
Start-up Screen	172		
Start-up Sound	176		

Memo

Memo