

# PENTAX

EN

## smc PENTAX-DA INTERCHANGEABLE LENS OPERATING MANUAL

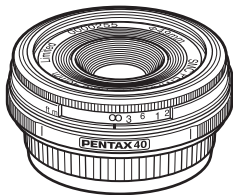
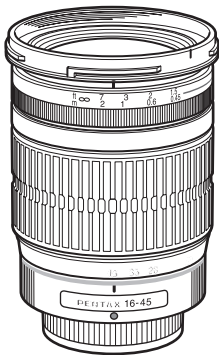

## FOREWORD

Thank you for purchasing the smc PENTAX-DA lens.

Please read this operating manual carefully before using the lens to ensure that it is used properly. In addition, also refer to your camera operating manual.

**smc PENTAX-DA lens can be used exclusively with PENTAX digital SLR cameras. This lens is not compatible with film SLR cameras.**

- In this operating manual, “smc PENTAX-DA lens” is shortened to “DA lens.”
- Illustrations shown herein may differ from the actual appearance.
- PENTAX and smc PENTAX are trademarks of HOYA CORPORATION.
- SDM is a trademark of HOYA CORPORATION.

Although we have carefully designed these lenses for safe operation, please pay special attention to items marked with the following symbols when using this product.



## **WARNING**

This symbol indicates precautions that if not followed, could result in serious injuries to the user.



## **CAUTION**

This symbol indicates precautions that if not followed, could result in minor or medium injuries to the user or damage to the equipment.



## **WARNING**

- **Never look at the sun through the lens or camera for a long time. Serious damage to the retina or total loss of eyesight may occur, particularly when looking directly through the lens.**



## **CAUTION**

- **Do not leave the lens in direct sunlight without the lens cap. Direct sunlight passing through the lens will be intensified, and should it focus on flammable materials, fire may occur.**

1. Storage and mildew prevention
  - Take the lens out of the protective case or camera bag, and store it in a dry, well-ventilated place.
  - Avoid storing the lens in a poorly ventilated location such as a closet, wardrobe, drawer, vehicle, or where insect repellent or medicine is kept.
  - Avoid storing the lens in areas of high temperature and humidity, where there is a risk of mildew growth. Store the lens with a desiccant in a dry cabinet, airtight container, or plastic bag. (Leaving a saturated desiccant in the storage container can cause damage to the lens. Be sure to read the instructions that come with the desiccant before use.)
2. The following lenses are dust and water resistant.  
(DA★ 300mm f/4ED [IF] SDM, DA★ 200mm f/2.8ED [IF] SDM, DA★ 16-50mm f/2.8ED AL [IF] SDM, DA★ 50-135mm f/2.8ED [IF] SDM)  
Lenses other than those listed above are not dust and water resistant. Be careful not to allow dust, dirt, water, harmful gases, salt, or other materials to get on those lenses.
3. When the lens is not attached to the camera body, attach both the supplied lens cap and lens mount cap to protect it from dust, etc.
4. Never use any organic solvent such as thinner, alcohol, or benzine, etc. to remove dust on the lens.
5. The lens is a precise optical instrument. Be careful not to let it fall, or subject it to strong shocks or pressure. Use a cushion or similar pad to protect the lens from the vibrations of motorcycles or other vehicles, boats, etc.
6. Avoid subjecting the lens to rapid changes in temperature, otherwise condensation can occur on both the inside and the outside of the lens. Put the lens in a plastic bag or camera bag, and take it out after the lens has reached ambient temperature.
7. Do not leave the camera with the lens cap off attached to a tripod or other rigid camera support. The inner parts of the camera can be damaged by direct sunlight.
8. Have the lens inspected by a dealer every one or two years to maintain its high performance.

<b>FOREWORD</b>	
<b>USING YOUR LENS SAFELY</b> .....	<b>1</b>
<b>PRECAUTIONS AND LENS MAINTENANCE</b> .....	<b>2</b>
<b>FEATURES OF THE smc PENTAX-DA LENS</b> .....	<b>6</b>
<b>smc PENTAX-DA LENS</b> .....	<b>7</b>
About the DA lens mount .....	8
About lenses with a supersonic motor .....	9
Precautions for using lenses equipped with a supersonic motor on the <i>K10D</i> .....	9
<b>MOUNTING AND REMOVING THE LENS</b> .....	<b>10</b>
<b>LENS CAP</b> .....	<b>11</b>
Attaching the dedicated lens cap to DA 40mm f/2.8 Limited .....	12
<b>FOCUSING</b> .....	<b>13</b>
Changing the Focus Mode .....	13
For the DA <sup>★</sup> lens .....	13
Using Autofocus .....	14
Focusing with the OK Button .....	14
Using Manual Focus .....	16
Using the Quick-Shift Focus System .....	16
How to use the Quick-Shift Focus System .....	17
DA <sup>★</sup> 200mm f/2.8ED [IF] SDM, DA <sup>★</sup> 300mm f/4ED [IF] SDM focusing .....	19

Precautions on close-distance scale .....	20
<b>ZOOM LENS</b> .....	<b>21</b>
About the zoom ring .....	22
About the zoom lock switch .....	23
<b>MACRO LENS</b> .....	<b>24</b>
Magnification Scale .....	24
<b>ATTACHING THE LENS HOOD</b> .....	<b>25</b>
Screw-on Type (DA 70mm f/2.4 Limited dedicated lens hood) .....	25
Screw-on Type (DA 40mm f/2.8 Limited dedicated lens hood) .....	26
Bayonet Type .....	26
Bayonet Type (DA 21mm f/3.2 AL Limited dedicated lens hood) .....	27
About the PL filter window .....	28
How to Use the Built-in Hood .....	30
<b>FILTERS</b> .....	<b>31</b>
Precaution on filters .....	31
Attaching the 30.5mm filter to the DA 40mm f/2.8 Limited lens .....	31
Attaching a filter and the dedicated lens hood to the DA 21mm f/3.2 AL Limited lens .....	32
Attaching a filter and the dedicated lens hood to the DA 70mm f/2.4 Limited lens .....	33
Circular polarizing filters and vignetting .....	34

Compatibility table for PENTAX circular polarizing filters .....	35
<b>PRECAUTIONS WHEN USING THE LENS WITH A FLASH .....</b>	<b>38</b>
Built-in Flash .....	38
External Flash .....	38
Compatibility of DA Lenses with the Built-in Flash .....	40
<b>TRIPOD MOUNT .....</b>	<b>42</b>
Removing the Tripod Mount .....	43
<b>MAIN SPECIFICATIONS .....</b>	<b>44</b>

- The smc PENTAX-DA lens is an interchangeable lens specifically designed for digital cameras. Its image circle is specialized for the image sensor (23.5 x 15.7mm) and its optical system is optimized for the characteristics of digital images.
- When autofocusing is finished, it is possible to make fine adjustments by hand using the “Quick-Shift Focus System” (see page 17 for details).
- Lenses that have “SDM” in their name are equipped with a supersonic motor. When mounted on a camera that supports supersonic motors, the autofocus is quiet and smooth.
- The following lenses are dust and water resistant because each part is individually sealed. This makes it difficult for dust and water to enter inside the lens.  
DA<sup>★</sup> 300mm f/4ED [IF] SDM, DA<sup>★</sup> 200mm f/2.8ED [IF] SDM, DA<sup>★</sup> 16-50mm f/2.8ED AL [IF] SDM, DA<sup>★</sup> 50-135mm f/2.8ED [IF] SDM

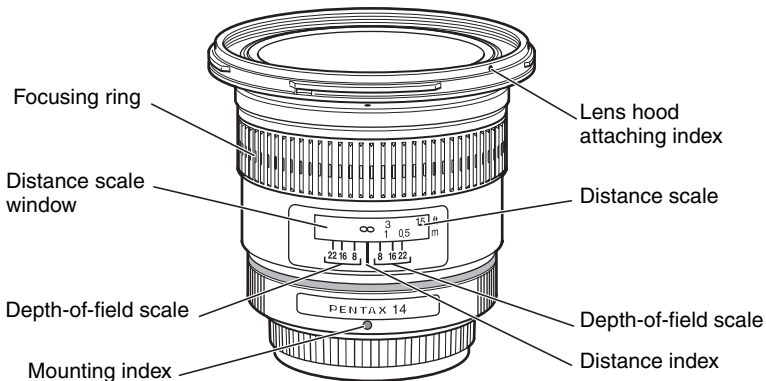

**Note:**

- The DA lens does not have an aperture ring. Aperture settings are controlled automatically as if set to the auto “A” position, so accessories without an auto “A” setting cannot be used with this lens.
- The DA lens is not compatible with film SLR cameras.

## About the DA lens mount

The DA lens is an interchangeable lens specifically designed for the PENTAX digital SLR cameras.

The DA lens has two types of mounts, the  $K_{AF}$  and the  $K_{AF2}$ .

Unlike the  $K_{AF}$ , the  $K_{AF2}$  mount has power supply contacts to allow operation of the supersonic motor.

For information on camera mount names, consult the operating manual.

**$K_{AF}$ -mount**

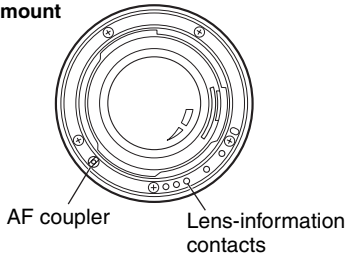

**$K_{AF2}$ -mount**

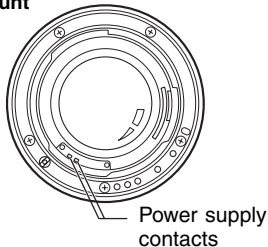

### CAUTION

Be careful not to damage or dirty the lens-information contacts and AF coupler on the mount surfaces of the camera and lens. Otherwise, failure or malfunction may result.

## About lenses with a supersonic motor

The following lenses are equipped with an internal supersonic motor. When mounted on a camera body that supports supersonic motors, the autofocus is quiet and smooth.

DA\* 16-50mm f/2.8ED AL [IF] SDM, DA\* 50-135mm f/2.8ED [IF] SDM, DA\* 200mm f/2.8ED [IF] SDM, DA\* 300mm f/4ED [IF] SDM

- **Supersonic motor compatible camera body**

*K20D, K200D, K10D, K100D Super*

### Note:

- **When the lens is mounted on a camera body that does not support supersonic motors, the autofocus is operated by the AF motor in the camera body.**

## Precautions for using lenses equipped with a supersonic motor on the *K10D*

When using lenses equipped with a supersonic motor on the *K10D*, use the camera firmware version 1.30 or later. The previous firmware versions will use the motor in the camera and not the motor in the lens to operate the AF.

- **How to Check and Update the Firmware**

Holding-down the MENU button while turning ON the *K10D* will display the firmware version in the center of the display.

Download and install the firmware update for the *K10D* using the link below.

- **Firmware Download Page:**

[http://www.pentax.jp/english/support/download\\_digital.html](http://www.pentax.jp/english/support/download_digital.html)

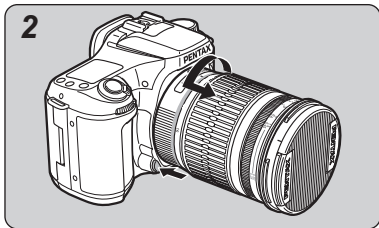
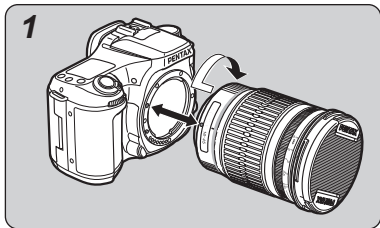

### 1. To mount the lens on the camera body

Attach the lens while aligning the red dots on the lens and body, then turn the lens clockwise until it clicks in place.

#### Memo:

- Do not hold down the lens unlock button while mounting the lens, otherwise the lens will not be properly mounted.
- After mounting the lens, gently turn the lens counterclockwise to make sure it is locked in place.

### 2. To remove the lens

Hold down the lens unlock button on the camera body and turn the lens counterclockwise.

Take off the lens cap by pressing the two tabs inward.

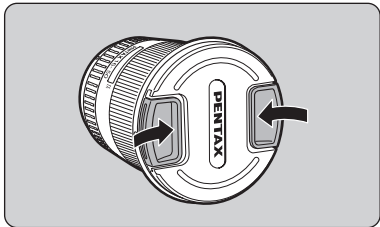
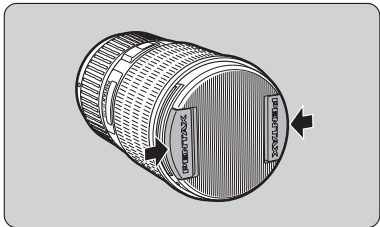

 **Memo:**

- When not using the lens, be sure to attach the lens cap.
- Attach the dedicated lens cap over the lens hood on the DA 21mm f/3.2 AL Limited, DA 35mm f/2.8 Macro Limited, DA FISH-EYE 10-17mm f/3.5-4.5ED [IF], and DA 70mm f/2.4 Limited. Also, with the DA 21mm f/3.2 AL Limited, DA 40mm f/2.8 Limited, DA 70mm f/2.4 Limited, it is possible to mount the F49mm lens cap (option) by removing the lens hood.

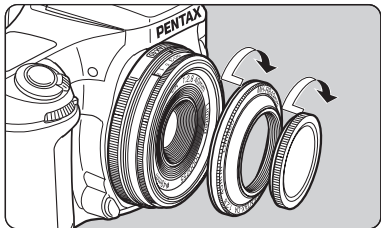

### **Attaching the dedicated lens cap to DA 40mm f/2.8 Limited**

First screw the dedicated hood onto the front of the lens, then screw the lens cap onto the lens hood.

## Changing the Focus Mode

Use the camera's focus mode switch to change between the autofocus mode and manual focus mode. For details, refer to your camera operating manual.

### For the DA<sup>★</sup> lens

The focus mode switch on the DA<sup>★</sup> lens is used to change between the autofocus and manual focus modes (the focus mode switch on the camera is always set to autofocus).

To use the autofocus, set the switch to the AF position.

To use the manual focus, set the switch to the MF position.

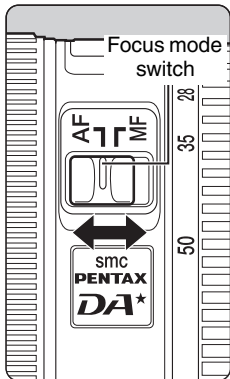

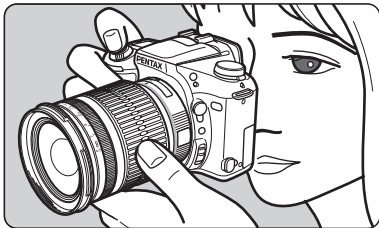

## Using Autofocus

Set the focus mode to autofocus. Press the shutter release button halfway to autofocus. With the *K20D*, *K10D* or *\*istD* camera, you can also press the AF button to autofocus. See page 13 for information about changing the focus mode.

## Focusing with the OK Button

With the *K200D*, *K100D Super*, *K110D*, *K100D*, *\*istDL2*, *\*istDS2*, *\*istDL* or *\*istDS* camera set as explained below, autofocusing by pressing the shutter release button halfway will be disabled and the OK button can be used instead to autofocus.

*K200D* / *K100D Super* / *K110D* / *K100D* / *\*istDL2* / *\*istDS2* / *\*istDL* / *\*istDS* :  
On the **C** Custom menu, select “Enable AF” for “OK btn when shooting”.

### Memo:

- For details on the setting procedure, refer to the camera operating manual.



## CAUTION

During autofocus, the focusing ring of the following lenses will rotate.

- **To prevent malfunction, do not touch the focusing ring during autofocus. Particularly be careful when the Focus Mode is set to A.F.C (AF-continuous). The camera continues adjusting the focus while the AF button is pressed or the shutter release button is pressed halfway.**

- DA FISH-EYE 10-17mm f/3.5-4.5ED [IF]
- DA 12-24mm f/4ED AL [IF]
- DA 16-45mm f/4ED AL
- DA 18-55mm f/3.5-5.6 AL II
- DA 18-55mm f/3.5-5.6 AL
- DA 18-250mm f/3.5-6.3ED AL [IF]
- DA 50-200mm f/4-5.6ED
- DA 55-300mm f/4-5.8ED
- DA 21mm f/3.2 AL Limited
- DA 35mm f/2.8 Macro Limited
- DA 40mm f/2.8 Limited
- DA 70mm f/2.4 Limited

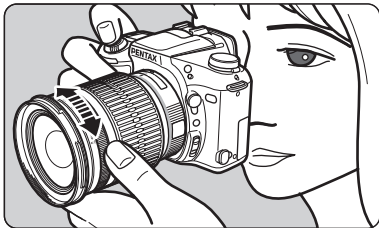

### Using Manual Focus

Set the focus mode to MF, and turn the focusing ring to focus manually. See page 13 for information about changing the focus mode.

### Using the Quick-Shift Focus System

If the focus mode is set to autofocus, you can focus manually after autofocus is achieved. Manually turn the focusing ring to finely adjust the focus. You can do this without changing the focus mode to MF.

\* The Quick-Shift Focus System is not available with the DA 18-250mm f/3.5-6.3ED AL [IF].

## How to use the Quick-Shift Focus System

### 1. Using Autofocus

Set the focus mode switch to autofocus, then press the shutter release button halfway to autofocus.

With the *K20D*, *K10D* or *\*istD* camera, you can also press the AF button to focus.

With the *K200D*, *K100D Super*, *K110D*, *K100D*, *\*istDL2*, *\*istDS2*, *\*istDL* or *\*istDS* camera set as explained in “Focusing with the OK Button” on page 14, you can focus by pressing the OK button.

- 2. Hold down the shutter release button halfway (or hold down the AF button or OK button), then turn the focusing ring to finely adjust focus.**
- 3. Finally, press the shutter release button fully to take a picture.**

The focusing ring on some lenses may rotate during autofocus.

- Do not touch the focusing ring while autofocus is operating as it may cause a malfunction. For more information see “CAUTION” on page 15.

## CAUTION

- When using the Quick-Shift Focus System, keep pressing the shutter release button (or AF button) after you achieve focus and before taking a picture. If you let go of the shutter release button before taking the picture, autofocus will operate all over again when you press the shutter release button again.

However, you can use the menus to set the camera according to the procedure below so you can take the picture without autofocusing after letting go of the shutter release button. See the camera operating manual for details about the setting procedure.

- For the *K20D*, *K10D* and the *\*istD*  
*K20D*, *K10D*: “C Custom Setting” menu → “AF by Press Halfway” → “Off”  
*\*istD*: “Custom function” → “AF with Press Halfway” → “Off”

### Memo:

- Use the AF button to focus when using autofocus.
- For the *K200D*, *K100D Super*, *K110D*, *K100D*, *\*istDL2*, *\*istDS2*, *\*istDL* and *\*istDS*  
 “C Custom Setting” menu → “OK btn when shooting” → “Cancel AF”

### Memo:

- When the OK button is pressed, focus temporarily changes to manual focus.

**DA★ 200mm f/2.8ED [IF] SDM, DA★ 300mm f/4ED [IF] SDM focusing**

- The mechanism does not allow the angle of rotation of the focusing ring and the distance scale to align while focusing. Always check the focus using the view finder before taking a picture. This is especially true with manual focus and the Quick-Shift Focus System.
- When focusing with manual focus or the Quick-Shift Focus System, the mechanism allows the focusing ring to rotate freely after it is set to  $\infty$  (infinity) or the minimum focus distance.

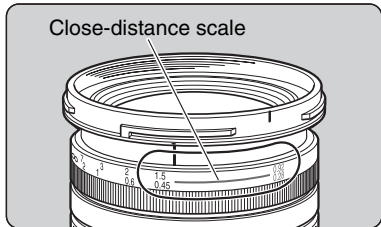

### **Precautions on close-distance scale**

**(For DA 16-45mm f/4ED AL, DA 18-55mm f/3.5-5.6 AL II, DA18-55mm f/3.5-5.6 AL)**

In the close-distance scale range (the orange area on the distance scale), when shooting at the maximum aperture, image quality deterioration in the picture corners may result because of the optical characteristics of the lens.

When taking a picture in this range, we recommend that you use a smaller aperture, stopping down from full aperture.

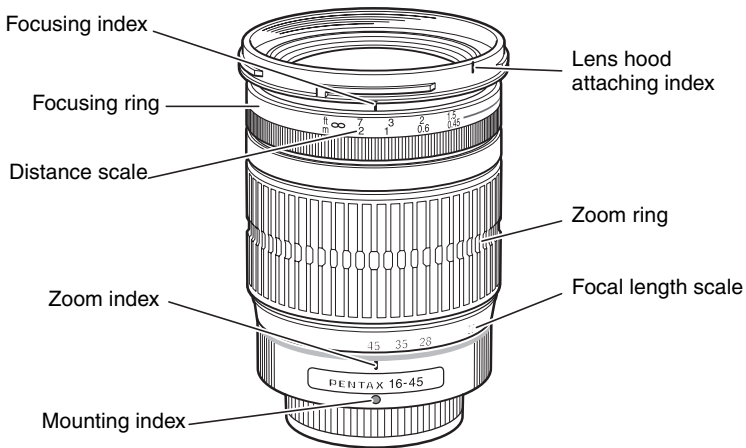

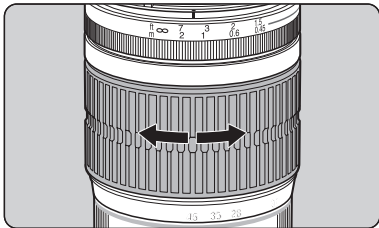

The zoom lens has a focusing ring on the front side and a zoom ring on the rear side. Turn the zoom ring to set the desired angle of view (lens focal length).

 **Memo:**

- The focusing point may shift slightly by changing the focal length. First adjust the zoom and then adjust focus.

### **About the zoom ring**

Turn the zoom ring clockwise for telephoto and counterclockwise for wide-angle.



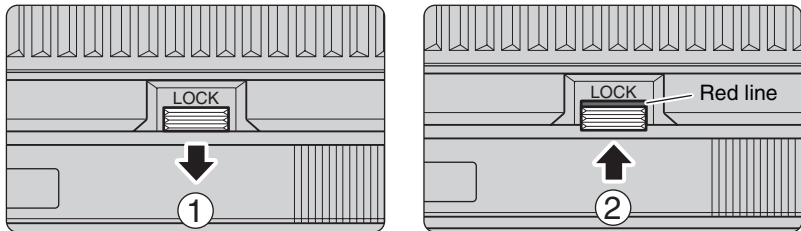

### About the zoom lock switch

The DA 18-250mm f/3.5-6.3ED AL [IF] is equipped with a zoom ring lock. This prevents the lens from extending under its own weight while you are carrying the camera.

1. Set the zoom ring to the widest angle (18mm).
2. Move the lock switch in the direction of ①.

The lock is engaged and the zoom ring is immovable when the red line is visible.

To zoom in the telephoto direction, move the lock switch in the direction of ②.

- \* If the switch does not move, the lens may be extended. Do not attempt to force the switch. Check the lens and try again.

## MACRO LENS

DA 35mm f/2.8 Macro Limited lens adjust focus from infinity to life-size [1x].

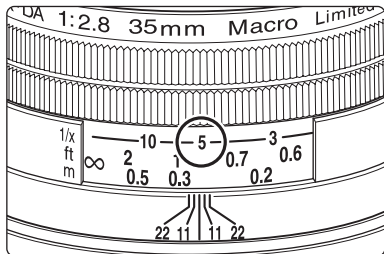

### Magnification Scale

The magnification is indicated by denominators on the distance scale. "5" indicates "1/5x". When determining the magnification first, set the magnification in the manual focus mode and adjust focus by moving the camera closer or further from the subject.

In order to avoid the deterioration in image quality from internal reflection, use of the lens hood is recommended.



**a. Screw-on Type (DA 70mm f/2.4 Limited dedicated lens hood)**

Screw the hood on to the front of the lens to attach it.  
The hood is telescopic. Extend it fully to use it.

**Memo:**

The lens hood cannot be mounted on some circular polarizing filters that are not produced by PENTAX, depending on the type.

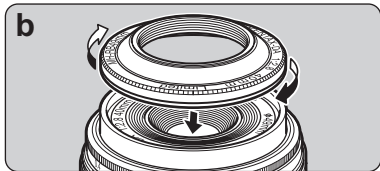

### **b. Screw-on Type (DA 40mm f/2.8 Limited dedicated lens hood)**

Screw the hood on to the front of the lens to attach it.

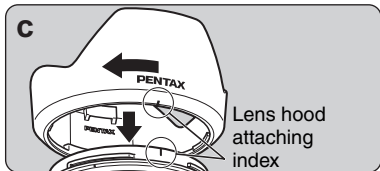

### **c. Bayonet Type**

When attaching the lens hood, align the index on the lens hood with the attaching index on the lens, and push both parts straight toward each other. Attach the lens hood on the lens by turning the hood in the clockwise direction to lock it as viewed from the front of the lens until it clicks into position.

#### **Memo:**

- When attaching the lens hood, hold the focusing ring and zoom ring securely to prevent them from turning.
- When the lens hood is not in use, it can also be turned around and attached in the reversed position.

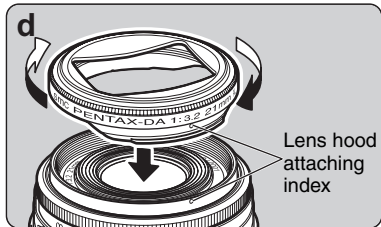

#### **d. Bayonet Type (DA 21mm f/3.2 AL Limited dedicated lens hood)**

When attaching the lens hood, align the index on the lens hood with the attaching index on the lens, and push both parts straight toward each other. Attach the lens hood on the lens by turning the hood in a clockwise direction, as seen from the front of the lens, until it stops.

#### **Memo:**

- Vignetting occurs if the camera is used while the hood is not completely attached.
- The dedicated lens hood cannot be attached if a filter is attached to the front of the lens. To use a filter and the dedicated lens hood together, attach a 43mm diameter filter to the back of the hood. (Refer to page 32)

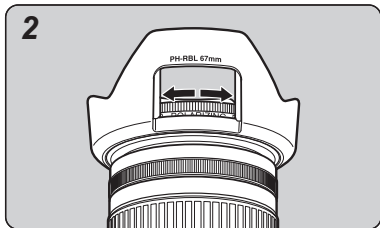
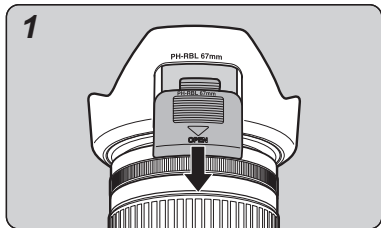

### About the PL filter window

If a circular polarizing filter is attached to the DA lens, you can easily turn the filter via the PL filter window on the bayonet-type hood.

Lens with hood with a PL filter window

- |                                   |                                 |
|-----------------------------------|---------------------------------|
| - DA 14mm f/2.8ED [IF]            | - DA★ 50-135mm f/2.8ED [IF] SDM |
| - DA 16-45mm f/4ED AL             | - DA 50-200mm f/4-5.6ED         |
| - DA★ 16-50mm f/2.8ED AL [IF] SDM | - DA 55-300mm f/4-5.8ED         |
| - DA 18-55mm f/3.5-5.6 AL II      | - DA 35mm f/2.8 Macro Limited   |
| - DA 18-55mm f/3.5-5.6 AL         | - DA★ 200mm f/2.8ED [IF] SDM    |
|                                   | - DA★ 300mm f/4ED [IF] SDM      |

## How to use the lens hood with polarizing filter window

1. Remove the PL filter window cap by sliding it in the direction as shown above.
2. Turn the outer rim of the circular polarizing filter from the PL filter window as shown above.

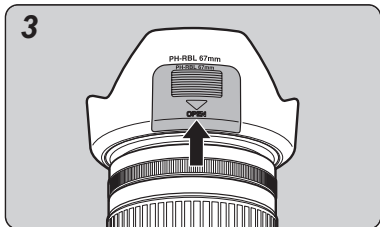

3. Attach the PL filter window cap.

### Memo:

- When shooting, be sure the PL filter window cap is in place to use the lens hood to maximum effect.

## How to Use the Built-in Hood

To use a lens with a built-in hood, first extend the hood to the fullest position.

Lenses with Built-in Hoods

DA 35mm f/2.8 Macro Limited

DA FISH-EYE 10-17mm f/3.5-4.5ED [IF]



Make sure the filter size matches the lens, then screw the filter onto the front of the lens.

 **Memo:**

- The compatible filter size for each lens is listed on pages 44-49.
- Filters cannot be mounted on the DA FISH-EYE 10-17mm f/3.5-4.5ED [IF].

### Precaution on filters

- Since a filter becomes a part of the optical system when attached on the lens, handle it in the same way you handle the lens with care to dust, dirt and scratches. Normally, attaching two or more filters on a lens does more harm than good. However, attaching a circular polarizing filter and another filter would not be a problem.
- Use a circular polarizing filter with an autofocus camera for proper exposure and autofocusing.

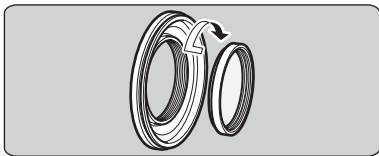

### Attaching the 30.5mm filter to the DA 40mm f/2.8 Limited lens

Normally, you attach the 49mm filter to the front of the lens. But you can also screw a 30.5mm filter to the back of the dedicated hood.

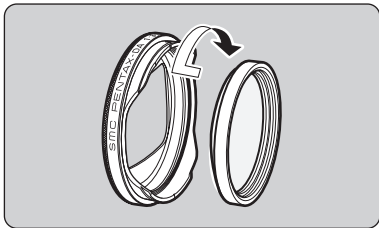

### **Attaching a filter and the dedicated lens hood to the DA 21mm f/3.2 AL Limited lens**

It is possible to attach a 49mm diameter filter to the front of the DA 21mm f/3.2 AL Limited lens, but not when the dedicated lens hood is attached. To use a filter with the dedicated lens hood, screw a 43mm diameter filter to the back of the lens hood.

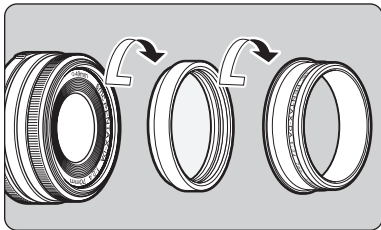

### **Attaching a filter and the dedicated lens hood to the DA 70mm f/2.4 Limited lens**

With the DA 70mm f/2.4 Limited lens, attach the 49mm diameter filter to the front of the lens. To use it together with the dedicated lens hood, screw it on over the filter that is attached.

#### **Memo:**

- The lens hood cannot be mounted on some circular polarizing filters that are not produced by PENTAX, depending on the type.

## Circular polarizing filters and vignetting

Circular polarizing filters are thicker than regular filters. Depending on the lens that is mounted and the shooting conditions, vignetting may occur in the four corners of the image. Refer to the “Compatibility table for PENTAX circular polarizing filters” on the following page for information on compatibility of the PENTAX circular polarizing filters (currently not available) with various lenses. There are two types of PENTAX circular polarizing filters: the A type (on the left in the diagram below) and the B type (on the right in the diagram below). The B type filter is thinner than the A type filter.

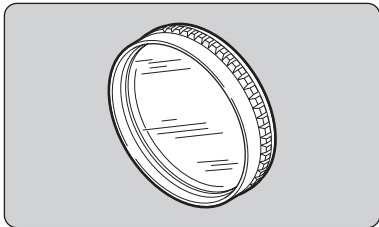

A type

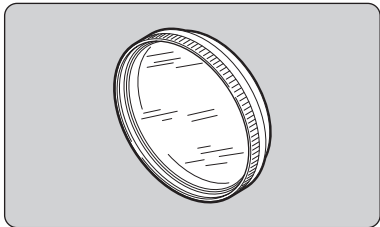

B type

## Compatibility table for PENTAX circular polarizing filters

\* PENTAX circular polarizing filters are not currently available.

\* PENTAX does not produce a circular polarizing filter with a 62mm diameter that can be used with the DA 18-250mm f/3.5-6.3ED AL [IF].

YES: Compatible \*YES: Compatible in some conditions NO: Incompatible

Lens	Circular polarizing filter (A type)		Circular polarizing filter (B type)	
	Compatibility	Notes	Compatibility	Notes
DA 14mm f/2.8ED [IF]	NO	Vignetting occurs.	YES	
DA 21mm f/3.2 AL Limited* <sup>3</sup>	YES	Use a filter with a diameter of 49mm.	YES	Use a filter with a diameter of 49mm.
DA 35mm f/2.8 Macro Limited	*YES	*Can be mounted and used. However, the built-in lens hood cannot be withdrawn while the A type circular polarizing filter is attached.	YES	
DA 40mm f/2.8 Limited* <sup>1</sup>	YES	Use a filter with a diameter of 49mm.	YES	Use a filter with a diameter of 49mm.
DA 70mm f/2.4 Limited* <sup>1</sup>	YES		YES	

Lens	Circular polarizing filter (A type)		Circular polarizing filter (B type)	
	Compatibility	Notes	Compatibility	Notes
DA* 200mm f/2.8ED [IF] SDM	*YES	*Can be mounted and used. However, when the A type of circular polarizing filter is mounted, the mount of the dedicated bayonet hood interferes with the filter's mount so it cannot be mounted on that.	YES	
DA* 300mm f/4ED [IF] SDM				
DA 12-24mm f/4ED AL [IF]* <sup>2</sup>	*YES	*Vignetting occurs at focal lengths below 15mm.	*YES	*Vignetting occurs at focal lengths below 15mm.
DA* 16-50mm f/2.8ED AL [IF] SDM	NO	Vignetting occurs.	YES	
DA* 50-135mm f/2.8ED [IF] SDM	YES		YES	
DA 16-45mm f/4ED AL	*YES	*Can be mounted and used. However, when the A type of circular polarizing filter is mounted, the mount of the dedicated bayonet hood interferes with the filter's mount so it cannot be mounted on that.	YES	
DA 18-55mm f/3.5-5.6 AL II				
DA 18-55mm f/3.5-5.6 AL				
DA 50-200mm f/4-5.6ED				
DA 55-300mm f/4-5.8ED				

- \*1 The lens hood cannot be mounted on some circular polarizing filters that are not produced by PENTAX, depending on the type.
- \*2 Vignetting occurs at focal lengths below 15mm with other PENTAX filters (such as the Skylight) besides circular polarizing filters.
- \*3 The dedicated hood cannot be mounted if a filter is mounted on the front of the lens, including circular polarizing filters.

 **Memo:**

- Filters, including circular polarizing filters, cannot be mounted on the DA FISH-EYE 10-17mm f/3.5-4.5ED [IF] lens.

### Built-in Flash

The built-in flash can not be used when the distance is less than 0.7m. When the flash is used within 0.7m, it causes incorrect exposure control and vignetting in the picture corners.

- Refer to the “Compatibility of DA Lenses with the Built-in Flash” chart on page 40 for information on the compatibility of the built-in flash with the lens being used.
- If the built-in flash is used with the lens hood attached to the lens, the flash light will be blocked by the lens hood. Always make sure to remove the lens hood before using the built-in flash.

### External Flash

The external flash can be used while the lens hood is attached. However, the following conditions apply to some types of lens.

#### ●DA 14mm f/2.8ED [IF]

The AF540FGZ and AF360FGZ external flash units can only be used when the wide-angle panel is used (it is also possible to use the lens hood). Other external flash units are not recommended because their coverage angle is not compatible with the angle of view of the lens.

#### ●DA 21mm f/3.2 AL Limited

External flash units can be used while the lens hood is mounted without problems if it is possible to set their zoom [coverage angle] up to 28mm.

#### ●DA FISH-EYE 10-17mm f/3.5-4.5ED [IF]

External flash units cannot be used because their coverage angle is not compatible with the angle of view of the lens.



**●DA 12-24mm f/4ED AL [IF]**

PENTAX external flash units which cover a 24mm lens on a 35mm SLR, or 16mm lens on a digital SLR, can be used when the lens is set from 16mm to 24mm.

AF540FGZ and AF360FGZ can be used from 13mm to 24mm with the wide angle panel (In both cases, it is possible to use the lens hood). Please note that at focal lengths less than 13mm the corners of the picture will not be fully illuminated.

Other external flash units are not recommended, because their coverage angle is not wide enough to cover the angle of view of the lens.

**●DA★ 16-50mm f/2.8ED AL [IF] SDM****●DA 16-45mm f/4ED AL**

PENTAX external flash units which cover a 24mm lens on a 35mm SLR, or 16mm lens on a digital SLR, can be used with the lens hood without problems.

\* For more information, refer to the manual for the external flash unit.

## Compatibility of DA Lenses with the Built-in Flash

Lens	Compatibility			
	<i>*istD</i>	<i>*istDS</i> , <i>*istDS2</i> <i>*istDL</i> , <i>*istDL2</i>	<i>K200D</i> , <i>K100D Super</i> , <i>K110D</i> , <i>K100D</i>	<i>K20D</i> , <i>K10D</i>
DA 14mm f/2.8ED [IF]	NO	NO	NO	NO
DA 21mm f/3.2 AL Limited	YES	YES	YES	YES
DA 35mm f/2.8 Macro Limited	YES	YES	YES	YES
DA 40mm f/2.8 Limited	YES	YES	YES	YES
DA 70mm f/2.4 Limited	YES	YES	YES	YES
DA <sup>*</sup> 200mm f/2.8ED [IF] SDM	YES	YES	YES	YES
DA <sup>*</sup> 300mm f/4ED [IF] SDM	YES	YES	YES	YES
DA FISH-EYE 10-17mm f/3.5-4.5ED [IF]	NO	NO	NO	NO
DA 12-24mm f/4ED AL [IF]	NO	NO	NO	NO
DA <sup>*</sup> 16-50mm f/2.8ED AL [IF] SDM	YES*1	YES*2	YES*3	YES*3
DA 16-45mm f/4ED AL	YES*4	YES*4	YES*4	YES*4
DA 18-55mm f/3.5-5.6 AL II	YES	YES	YES	YES
DA 18-55mm f/3.5-5.6 AL	YES	YES	YES	YES
DA 18-250mm f/3.5-6.3ED AL [IF]	YES*5	YES*5	YES*5	YES*5
DA <sup>*</sup> 50-135mm f/2.8ED [IF] SDM	YES	YES	YES	YES

Lens	Compatibility			
	<i>*istD</i>	<i>*istDS</i> , <i>*istDS2</i> <i>*istDL</i> , <i>*istDL2</i>	<i>K200D</i> , <i>K100D Super</i> , <i>K110D</i> , <i>K100D</i>	<i>K20D</i> , <i>K10D</i>
DA 50-200mm f/4-5.6ED	YES	YES	YES	YES
DA 55-300mm f/4-5.8ED	YES	YES	YES	YES

Except for the DA 70mm f/2.4 Limited, DA 40mm f/2.8 Limited and DA 21mm f/3.2 AL Limited, do not use the lens hood when using the built-in flash. This is to prevent obstruction of the flash coverage by the lens hood.

- \*1 Vignetting occurs when the focal length is 35mm or less, or when the focal length is 16 to 50mm and the shooting distance is below 1.5 m.
- \*2 Vignetting occurs when the focal length is 28mm or less, or when the focal length is 16 to 50mm and the shooting distance is below 1.5 m.
- \*3 Vignetting occurs when the focal length is 20mm or less, or when the focal length is 35mm and the shooting distance is below 1.5 m.
- \*4 Vignetting occurs when the focal length is below 28mm, or when the focal length is 28mm and the shooting distance is 1 m or less.
- \*5 Vignetting occurs when the focal length is below 35mm.

## TRIPOD MOUNT

DA\* 300mm f/4ED [IF] SDM is equipped with the tripod mount. To position the camera vertically or horizontally, loosen the camera position shift lock screw, turn the camera 90° to the right or left as desired, and tighten the lock screw firmly. The tripod mount is detachable.

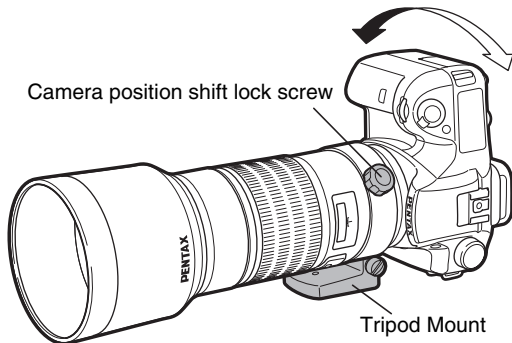

- Attach only to a stable tripod.
- We recommend using a fast shutter speed as large lenses may contribute to camera shake.

## Removing the Tripod Mount

To remove the mount, use a coin to loosen the screw by turning it counterclockwise.

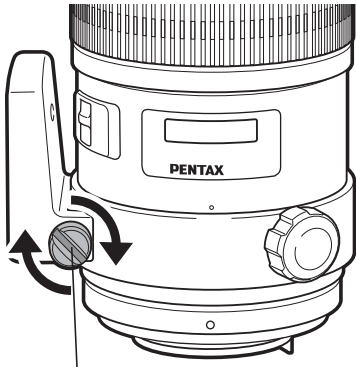

Insert a coin into the slot on the screw and turn it clockwise to tighten the screw and counterclockwise to loosen the screw.

# MAIN SPECIFICATIONS

\* For use with any PENTAX digital SLR camera.

\* AL = Uses an aspheric lens, ED = lens made with extra-low dispersion glass, IF = inner focus-type lens, SDM = lens with a supersonic motor

Lens	DA 14mm f/2.8ED [IF]	DA 21mm f/3.2 AL Limited	DA 35mm f/2.8 Macro Limited
Focal length	14mm (equivalent to approx. 21.5mm in 35mm format)	21mm (equivalent to approx. 32mm in 35mm format)	35mm (equivalent to approx. 53.5mm in 35mm format)
Elements in groups	12-11	8-5	9-8
Angle of view	90°	68°	44°
Aperture	f/2.8	f/3.2	f/2.8
Minimum aperture	f/22	f/22	f/22
Mount type	K <sub>AF</sub> -mount	K <sub>AF</sub> -mount	K <sub>AF</sub> -mount
Minimum focus distance	0.17m (0.56ft)	0.2m (0.66ft)	0.139m (0.46ft)
Maximum magnification	Approx. 0.19×	Approx. 0.17×	Approx. 1.00×
Filter size	77mm	49mm or 43mm	49mm
Lens hood	PH-RBH 77mm	MH-RBA 43mm	Built-in
Max. Diameter × Length	83.5mm × 69mm (3.3in × 2.7in)	63mm × 25mm (2.5in × 1.0in)	63mm × 46.5mm (2.5in × 1.9in)
Weight	Approx. 420g/14.8oz (with hood approx. 455g/ 16oz)	Approx. 140g/4.9oz (with hood approx. 155g/ 5.5oz)	Approx. 215g/7.58oz
Soft case	S100-120	Dedicated case	Soft case DA70

Lens	DA 40mm f/2.8 Limited	DA 70mm f/2.4 Limited	DA* 200mm f/2.8ED [IF] SDM
Focal length	40mm (equivalent to approx. 61mm in 35mm format)	70mm (equivalent to approx. 107mm in 35mm format)	200mm (equivalent to approx. 307mm in 35mm format)
Elements in groups	5-4	6-5	9-8
Angle of view	39°	23°	8.1°
Aperture	f/2.8	f/2.4	f/2.8
Minimum aperture	f/22	f/22	f/22
Mount type	K <sub>AF</sub> -mount	K <sub>AF</sub> -mount	K <sub>AF2</sub> -mount
Minimum focus distance	0.4m (1.31ft)	0.7m (2.3ft)	1.2m (4ft)
Maximum magnification	Approx. 0.13x	Approx. 0.12x	Approx. 0.20x
Filter size	49mm or 30.5mm	49mm	77mm
Lens hood	MH-RC 49mm	MH-RD 49mm	PH-RBK 77mm
Max. Diameter × Length	63mm × 15mm (2.5in × 0.6in)	63mm × 26mm (2.5in × 1.0in)	83mm × 134mm (3.3in × 5.4in)
Weight	Approx. 90g/3.15oz (with hood approx. 100g/ 3.5oz)	Approx. 130g/4.59oz (with hood approx. 150g/ 5.29oz)	Approx. 825g/29.1oz (with hood approx. 915g/ 32.27oz)
Soft case	Dedicated case	Soft case DA70	S120-160

Lens	DA* 300mm f/4ED [IF] SDM	DA FISH-EYE 10-17mm f/3.5-4.5ED [IF]	DA 12-24mm f/4ED AL [IF]
Focal length	300mm (equivalent to approx. 460mm in 35mm format)	10-17mm (35mm conversion not possible)	12-24mm (equivalent to approx. 18.5-37mm in 35mm format)
Elements in groups	8-6	10-8	13-11
Angle of view	5.4°	180°–100°	99°–61°
Aperture	f/4	f/3.5–f/4.5	f/4
Minimum aperture	f/32	f/22–f/32	f/22
Mount type	K <sub>AF2</sub> -mount	K <sub>AF</sub> -mount	K <sub>AF</sub> -mount
Minimum focus distance	1.4m (4.67ft)	0.14m (0.46ft) (Approximately 2.5cm from front of lens)	0.3m (0.98ft)
Maximum magnification	Approx. 0.24×	Approx. 0.39×	Approx. 0.12×
Filter size	77mm	Cannot be mounted	77mm
Lens hood	PH-RBK 77mm	Built-in	PH-RBI 77mm
Max. Diameter × Length	83mm × 184mm (3.3in × 7.4in)	68mm × 71.5mm (2.7in × 2.8in)	84mm × 87.5mm (3.3in × 3.4in)
Weight	Approx. 1070g/37.74oz (with hood approx. 1160g/ 40.91oz) (with hood + tripod mount approx. 1240g/43.73oz)	Approx. 320g/11.3oz	Approx. 430g/15.2oz (with hood approx. 457g/ 16.1oz)
Soft case	S120-210	S80-80	S100-120



Lens	DA 16-45mm f/4ED AL	DA <sup>*</sup> 16-50mm f/2.8ED AL [IF] SDM	DA 18-55mm f/3.5-5.6 AL II
Focal length	16-45mm (equivalent to approx. 24.5-69mm in 35mm format)	16-50mm (equivalent to approx. 24.5-76.5mm in 35mm format)	18-55mm (equivalent to approx. 27.5-84mm in 35mm format)
Elements in groups	13-10	15-12	11-8
Angle of view	83°-35°	83°-31.5°	76°-29°
Aperture	f/4	f/2.8	f/3.5-f/5.6
Minimum aperture	f/22	f/22	f/22-f/38
Mount type	K <sub>AF</sub> -mount	K <sub>AF2</sub> -mount	K <sub>AF</sub> -mount
Minimum focus distance	0.28m (0.92ft)	0.3m (0.98ft)	0.25m (0.82ft)
Maximum magnification	Approx. 0.26x	Approx. 0.21x	Approx. 0.34x
Filter size	67mm	77mm	52mm
Lens hood	PH-RBL 67mm	PH-RBJ 77mm	PH-RBA 52mm
Max. Diameter × Length	72mm × 92mm (2.8in × 3.6in)	84mm × 98.5mm (3.3in × 3.9in)	68mm × 67.5mm (2.7in × 2.6in)
Weight	Approx. 365g/12.9oz (with hood approx. 390g/ 13.8oz)	Approx. 565g/19.9oz (with hood approx. 600g/ 21.2oz)	Approx. 220g/7.76oz (with hood approx. 245g/ 8.64oz)
Soft case	S90-140	S100-140	S80-120

Lens	DA18-55mm f/3.5-5.6 AL	DA 18-250mm f/3.5-6.3ED AL [IF]	DA <sup>★</sup> 50-135mm f/2.8ED [IF] SDM
Focal length	18-55mm (equivalent to approx. 27.5-84mm in 35mm format)	18-250mm (equivalent to approx. 27.5-383mm in 35mm format)	50-135mm (equivalent to approx. 76.5-207mm in 35mm format)
Elements in groups	12-9	16-13	18-14
Angle of view	76°–29°	76°–6.5°	31.5°–11.9°
Aperture	f/3.5–f/5.6	f/3.5–f/6.3	f/2.8
Minimum aperture	f/22–f/38	f/22–f/45	f/22
Mount type	K <sub>AF</sub> -mount	K <sub>AF</sub> -mount	K <sub>AF2</sub> -mount
Minimum focus distance	0.25m (0.82ft)	0.45m (1.5ft)	1.0m (3.3ft)
Maximum magnification	Approx. 0.34x	Approx. 0.28x	Approx. 0.17x
Filter size	52mm	62mm	67mm
Lens hood	PH-RBA 52mm	PH-RBB 62mm	PH-RBK 67mm
Max. Diameter × Length	68mm × 67.5mm (2.7in × 2.6in)	75mm × 85.5mm (3.0in × 3.4in)	76.5mm × 136mm (3.0in × 5.4in)
Weight	Approx. 225g/7.9oz (with hood approx. 250g/ 8.8oz)	Approx. 455g/16.0oz (with hood approx. 470g/ 16.6oz)	Approx. 685g/24.2oz (with hood approx. 765g/ 27.0oz)
Soft case	S80-120	S80-120	S90-160

Lens	DA 50-200mm f/4-5.6ED	DA 55-300mm f/4-5.8ED
Focal length	50-200mm (equivalent to approx. 76.5-306mm in 35mm format)	55-300mm (equivalent to approx. 84.5-460mm in 35mm format)
Elements in groups	11-10	12-8
Angle of view	31.5°–8.1°	29°–5.4°
Aperture	f/4–f/5.6	f/4–f/5.8
Minimum aperture	f/22–f/32	f/22–f/32
Mount type	K <sub>AF</sub> -mount	K <sub>AF</sub> -mount
Minimum focus distance	1.1m (3.6ft)	1.4m (4.67ft)
Maximum magnification	Approx. 0.24x	Approx. 0.28x
Filter size	52mm	58mm
Lens hood	PH-RBB 52mm	PH-RBG 58mm
Max. Diameter × Length	66.5mm × 78.5mm (2.6in × 3.1in)	71mm × 111.5mm (2.8in × 4.5in)
Weight	Approx. 255g/9oz (with hood approx. 285g/10oz)	Approx. 440g/15.52oz (with hood approx. 470g/16.6oz)
Soft case	S80-120	S80-160

**For customers in USA****STATEMENT OF FCC COMPLIANCE**

This device complies with Part 15 of the FCC Rules. Operation is subject to the following two conditions : (1) This device may not cause harmful interference, and (2) this device must accept any interference received, including interference that may cause undesired operation.

Changes or modifications not approved by the party responsible for compliance could void the user's authority to operate the equipment.

This equipment has been tested and found to comply with the limits for a Class B digital device, pursuant to part 15 of the FCC Rules. These limits are designed to provide reasonable protection against harmful interference in a residential installation. This equipment generates, uses and can radiate radio frequency energy and, if not installed and used in accordance with the instructions, may cause harmful interference to radio communications. However, there is no guarantee that interference will not occur in a particular installation. If this equipment does cause harmful interference to radio or television reception, which can be determined by turning the equipment off and on, the user is encouraged to try to correct the interference by one or more of the following measures:

- Reorient or relocate the receiving antenna.  
Increase the separation between the equipment and receiver.  
Connect the equipment into an outlet on a circuit different from that to which the receiver is connected.
- \*Consult the dealer or an experienced radio/TV technician for help.

**For customers in Canada**

This Class B digital apparatus complies with Canadian ICES-003.

Cet appareil numérique de la classe B est conforme à la norme NMB-003 du Canada.

## Memo

## Memo

## Memo

**HOYA CORPORATION**  
**PENTAX Imaging System Division**

2-36-9, Maeno-cho, Itabashi-ku, Tokyo 174-8639, JAPAN (<http://www.pentax.jp>)

**PENTAX Europe GmbH** Julius-Vosseler-Strasse 104, 22527 Hamburg, GERMANY (HQ - <http://www.pentaxeurope.com>)  
**(European Headquarters)** (Germany - <http://www.pentax.de>) Hotline: 0180 5 736829 / 0180 5 PENTAX  
Austria Hotline: 0820 820 255 (<http://www.pentax.at>)

**PENTAX U.K. Limited** PENTAX House, Heron Drive, Langley, Slough, Berks SL3 8PN, U.K. (<http://www.pentax.uk>)  
Hotline: 0870 736 8299

**PENTAX France S.A.S.** 112 Quai de Bezons, B.P. 204, 95106 Argenteuil Cedex, FRANCE (<http://www.pentax.fr>)  
Hotline: 0826 103 163 (0,15€ la minute) Fax: 01 30 25 75 76  
Email: [http://www.pentax.fr/\\_fr/photo/contact.php?photo&contact](http://www.pentax.fr/_fr/photo/contact.php?photo&contact)

**PENTAX Italia S.r.l.** Via Dione Cassio 15, 20138 Milano, ITALY (<http://www.pentaxitalia.it>) Email : [info@pentaxitalia.it](mailto:info@pentaxitalia.it)

**PENTAX (Schweiz) AG** Widenholzstrasse 1, 8304 Wallisellen, Postfach 367 8305 Dietlikon, SWITZERLAND  
(<http://www.pentax.ch>)

**PENTAX Europe GmbH (Tyskland) Filial Sverige**  
Box 650, 75127 Uppsala, SWEDEN (<http://www.pentax.se>)

**PENTAX Imaging Company**  
**A Division of PENTAX of America, Inc.**

(Headquarters)  
600 12th Street, Suite 300 Golden, Colorado 80401, U.S.A.  
(PENTAX Service Department)  
12000 Zuni Street, Suite 100B Westminster, Colorado 80234, U.S.A.  
(<http://www.pentaximaging.com>)

**PENTAX Canada Inc.** 1770 Argentia Road Mississauga, Ontario L5N 3S7, CANADA (<http://www.pentax.ca>)  
**PENTAX Trading** 23D, Jun Yao International Plaza, 789 Zhaojabang Road, Xu Hui District, Shanghai, 200032  
**(SHANGHAI) Limited** CHINA (<http://www.pentax.com.cn>)



The CE Mark is a Directive conformity mark of the European Union.

☆Specifications and external dimensions are subject to change without notice.

Copyright © HOYA CORPORATION 2008